



Beta

www.beta-tools.com

-  Robur
-  BetaWORK
-  Beta Collection
-  Beta SHOP in shop

2020

general programme

EN



BETA: THE HISTORY OF ITALIAN TOOLS

1939

1923 - Alessandro Ciceri founded "Alessandro Ciceri & Figli", to manufacture iron and steel casts.
1939 - The trademark Beta was registered and the Company became involved mainly in manufacturing professional tools.

1950

1960 - Beta Utensili employed two hundred people, exported their products and stood out as an up-and-coming manufacturer of professional tools.

1969 - The revolutionary orange sheet metal "Tank" trolley was developed; from that moment orange would result in a unique style for the trademark Beta.

1971 - Beta Utensili entered the motor racing world, with a view to testing and developing their products.

1970

1975 - The Company scored their first Formula 1 victory with the orange **Beta Utensili March** driven by Vittorio Brambilla, who won the Austrian Grand Prix in Zeltweg, in the pouring rain.

1980 - Beta Utensili further penetrated the main European markets, progressively establishing branches in France, Britain, Holland, Spain and Poland.

2007

1995 - It took the Company no more than 8 months to have their **Quality System** certified in accordance with the **ISO 9001** standards.

2000 - launch of the new Beta Utensili catalogue testified to ongoing growth. The range of available products was doubled and the over 10,000 coded items were divided into 20 product ranges.

2002 - Beta Utensili's range was further expanded, being supplemented with safety footwear as well as with work and free-time wear, namely the "Beta Work" range.

2011 - Ongoing growth leading to today: a product range – distributed worldwide – which exceeds 10,000 coded items and satisfies the most demanding professionals' requirements.



CASTIGLIONE



SULMONA

2 0 1 1



1995

Beta Utensili manufactures its products in Italy, namely in the factories in Sovico (MB), Castiglione d'Adda (LO) and Sulmona (AQ), and employs over 500 staff.

Beta Utensili respects the environment, accurately selecting such materials and processes as to minimize the impact on the ecosystem.

Beta Utensili is active worldwide, through a high-performance logistic structure and a distribution network spanning the globe, with 6 foreign branches – in France, Britain, Holland, Spain, Poland and China respectively – and sales points in over 200 countries.

Beta Utensili is synonymous with quality, on the basis of stringent tests on their products and company processes, in accordance with the ISO9001 standards.

Beta Utensili has been a winner for forty years. An indissoluble link - supported by the best professionals involved in achieving outstanding results - which has long been sealed by partnerships with prestigious teams, including Ferrari, Jordan, McLaren and Minardi in Formula 1, and Honda, Suzuki, Kawasaki and Yamaha in MotoGP.



2009



1969

2006



2011



1976



2010

BETA UTENSILI S.p.A. - 20050 Sovico (MB) - Italy
Via A.Volta, 18 - Tel. +39.039.2077.1 - Telefax +39.039.2010742
www.beta-tools.com - info@beta-tools.com

Robur Wire rope accessories: 67039 Sulmona (AQ) - Italy
Zona industriale - C.da S. Nicola
Tel. +39.0864.2504.1 - Telefax +39.0864.253132
www.roburitaly.com - info@roburitaly.com

Beta Index

CONTAINERS AND ASSORTMENTS

☐ 189÷272



WRENCHES

☐ 8÷14, 18÷21, 79÷83



SOCKETS AND ACCESSORIES

☐ 47÷53, 58÷79



TORQUE WRENCHES AND MULTIPLIERS

☐ 41÷47



SCREWDRIVERS, MALE-END WRENCHES AND BITS

☐ 14÷18, 53÷58, 80÷83, 101÷111



PLIERS AND NIPPERS

☐ 88÷93, 97÷98, 161



HAMMERS AND CHISELS

☐ 7-8, 114÷117, 149-150



DRILLING AND THREADING TOOLS

☐ 28÷41



PULLERS

☐ 117-118, 131÷136, 138-139



MEASURING AND MARKING TOOLS

☐ 144÷150



CUTTING AND GENERAL MAINTENANCE TOOLS

☐ 86, 92÷96, 110, 126, 139-140, 143, 148, 150÷158, 161÷167



SPARKPROOF TOOLS

☐ 173÷176



PLUMBING TOOLS

☐ 21÷28



ELECTRONICS AND MICROMECHANICS

☐ 87-88, 99-100, 104, 153, 163-164



ELECTROTECHNICS

☐ 95÷97, 104, 140÷143, 156, 159-160, 166, 169÷172



VEHICLE REPAIR

☐ 48÷50, 83÷87, 92, 96, 111÷114, 117÷138, 144, 150, 154, 158÷161, 167-168



PNEUMATIC TOOLS

☐ 177÷188



ROBUR WIRE ROPE ACCESSORIES

☐ 341÷357



SAFETY FOOTWEAR (AND TECHNICAL SOCKS)

☐ 294÷321



WORKWEAR

☐ 322÷340



DISPLAY UNITS FOR SALES POINTS

☐ 278÷293

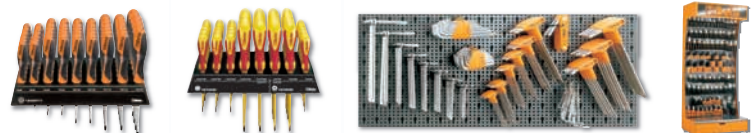

BETACOLLECTION

☐ 358÷366



BLISTER PACK RANGE

☐ 272÷277



Key

item number

1262

tool profile



screwdrivers
for cross head Phillips® screws

in blister pack



NEW ITEM 2011

size

UNI/ISO 8764 DIN 5262

PHxDxL mm	L1 mm		
0x3x60	160	5	012620003
0x3x100	200	5	012620006
1x4,5x80	188	5	012620009
1x4,5x120	228	5	012620012
2x6x100	219	5	012620018
2x6x150	269	5	012620021
3x8x150	277	3	012620024
4x10x200	327	3	012620027

n.° of tools per box

n.° of tools per set

● type of packaging

set content



code number

1262/S4
PH0x3x60-PH1x4,5x80
PH2x6x100-PH3x8x150 mm
1 012620304

Most used symbols

● Sets

	Example
B = in plastic wallet	42/B6
BV = empty wallet	42/BV6
C = in case	900/C11
D = in hanging pack	1293/D6
S = in box	42/S17
SP = with display	42/SP17
SPV = empty display	42/SPV1

Assortments

AS = with tools in inches	5915VU/AS
E = Electronics/Electrotechnics	2029ET/2
I = Plumbing	2009ID
MT = Earth-moving	5902MT
U = Universal	5957U
VG = Automotive	5904VG/5T
VI = Industry	5902VI
M = Motorcycle Repairs	5940M2

Sockets

A = hexagon profile	910A
B = bi-hex profile	910B
ES = grooved profile	920ES
FTX = for TORX® screws	910FTX

Most used symbols

PT = for 5-star head screws	910PT
X = reversible ratchet in cases	920A/C12X

Screwdrivers and bits

LP = for slotted head screws	920LP
PE = for hexagon screws	920PE
PH = for cross head PHILLIPS® screws	920PH
PZ = for cross head POZIDRIV® - SUPADRIV® screws	1299PZ
RTX = for TAMPER RESISTANT TORX® screws	1298RTX
SP = for SPANNER screws	861SP
TRW = for TRI-WING® screws	861TRW
TQS = for TORQ-SET® screws	861TQS
TX = for TORX® head screws	920TX
XZN = for XZN® screws	920XZN

Miscellaneous

AS = sizes in inches	42AS
BA = spark-proof tools	42BA
BM = bi-material handle	1150BM
C = empty metal container	C25
L = long series	952L
MQ = 1000V insulated tools	1150MQ
MP = bright finish	42MP
R = spare part	338R
TM = three-material handle	1152TM

The pictures are given by way of example.

Beta Utensili reserve the right to update and enhance their product range without notice.



Beta RECOMMENDS
using the tools correctly and complying
with personal protection standards.



30

drift punches



UNI 7501

Ø mm	L mm		
2	125	10	000300020
3	125	10	000300030
4	150	10	000300040
5	150	10	000300050
6	150	10	000300060

31

pin punches



UNI 7502

Ø mm	L mm	L1 mm		
2	110	22	10	000310002
3	128	35	10	000310003
4	146	45	10	000310004
5	164	55	10	000310005
6	182	65	5	000310006
8	200	80	5	000310008
10	220	95	5	000310010



31/B6



31/SP6

31/B6	2-3-4-5-6-8	1	000310020
42/BV6		1	000420051
31/SP6	2-3-4-5-6-8	1	000310030
31/SPV		1	000310031

31BM

pin punches with handles



Ø mm	L mm	L1 mm		
2	168	103	3	000310402
3	180	103	3	000310403
4	191	103	3	000310404
5	200	103	3	000310405
6	221	109	3	000310406
8	235	109	3	000310408



31BM/S6	2-3-4-5-6-8	1	000310421
---------	-------------	---	-----------

31L

pin punches, long series

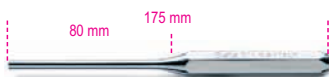

Ø mm			
4	5	000310104	
5	5	000310105	
6	5	000310106	

31SE

punches for spring pins

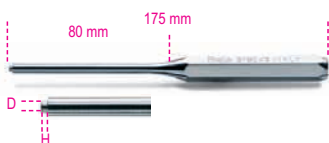

Ø mm	D mm	H mm		
4	2,4	2	5	000310204
5	3,0	2	5	000310205
6	3,6	2	5	000310206



31/B6-LSE	31L: 4-5-6 + 31SE: 4-5-6	1	000310320
31/BV-LSE		1	000310022

32

centre punches



UNI 7503

Ø mm	L mm		
3	100	10	000320100
4	125	10	000320125
5	150	10	000320150

32AU

automatic centre punches



Ø mm	L mm		
3	150	2	000320160

32AUR

spare tip for automatic centre punch



Ø mm			
3	5	000320170	

34

flat chisels



UNI 7504

L mm	A mm		
125	14,5	5	000340001
150	17,0	5	000340002
175	21,5	5	000340003

35

flat chisels, ribbed type



UNI 7506

L mm	A mm		
100	14,5	10	000350001
125	17,0	10	000350002
150	20,5	10	000350003
200	23,0	10	000350004
250	28,5	3	000350005
300	34,0	3	000350006



35PM

flat chisels, ribbed type
with hand guards



L mm	A mm		
200	23,0	2	000350014
250	28,5	2	000350015
300	34,0	2	000350016

35PMR

spare hand guards



L mm			
200		1	000350024
250		1	000350025
300		1	000350026

36

cape chisels



UNI 7505

L mm	A mm		
125	4	5	000360001
150	6	5	000360002

37

cape chisels, ribbed type



UNI 7507

L mm	A mm		
150	6	5	000370001
200	8	3	000370002

37PM

cape chisel, ribbed type
with hand guard



L mm	A mm		
200	8	2	000370012

37PMR

spare hand guard



L mm			
200		1	000370022



38/B6



38/SP6

38/B6		1	000380006
30: 2-3			
32: 4			
34: 125-150			
36: 150			
42/BV6		1	000420051
38/SP6		1	000380009
30: 2-3			
32: 4			
34: 125-150			
36: 150			
38/SPV		1	000380019

42

combination wrenches,
open and offset ring ends



UNI/ISO 7738 DIN 3113

mm	L mm		
5,5x5,5	95	10	000420005
6x6	95	10	000420006
7x7	105	10	000420007
8x8	116	10	000420008
9x9	127	10	000420009
10x10	137	10	000420010
11x11	148	10	000420011
12x12	158	10	000420012
13x13	169	10	000420013
14x14	180	10	000420014
15x15	190	10	000420015
16x16	201	10	000420016
17x17	212	10	000420017
18x18	222	10	000420018
19x19	233	10	000420019
20x20	243	5	000420020
21x21	254	5	000420021
22x22	264	5	000420022
23x23	275	5	000420023
24x24	285	5	000420024
25x25	296	5	000420025
26x26	307	5	000420026
27x27	317	5	000420027
28x28	328	5	000420028
29x29	338	5	000420029
30x30	349	5	000420030
32x32	370	5	000420032
34x34	391	1	000420034

mm	L mm		
35x35	412	1	000420035
36x36	412	1	000420036
38x38	433	1	000420038
41x41	465	1	000420041



42/B6		1	000420049
6-7-8-10-11-13			
42/BV6		1	000420051
42/B9		1	000420064
6-7-8-10-11-13-14-17-19			
42/BV9		1	000420056



42/S15		1	000420066
6-7-8-10-11-12-13-14-17			
19-22-24-27-30-32			
42/S17		1	000420065
6-7-8-9-10-11-12-13-14			
15-16-17-18-19-20-21-22			
42/S26		1	000420070
6-7-8-9-10-11-12-13-14			
15-16-17-18-19-20-21			
22-23-24-25-26-27-28			
29-30-32			

42/SC9I-E

set of 9 combination wrenches, open and
offset ring ends, with compact support



42/SC9I		1	000420087
8-10-11-12-13-14-15-17-19			
42/SCV9I		1	000420103
42/SC9E		1	000420088
8-10-11-12-13-16-17-18-19			
42/SCV9E		1	000420104

Beta





42/SP17 1 000420075
6-7-8-9-10-11-12-13-14
15-16-17-18-19-20-21-22

42/SPV1 1 000420080

42/SP25 1 000420085
6-7-8-9-10-11-12-13-14
15-16-17-18-19-20-21
22-23-24-25-26-27-28
30-32

42/SPV2 1 000420090



42/SP15

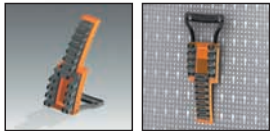

42/SPV...

42/SP15 1 000420078
6-7-8-9-10-11-12-13-14-15
16-17-19-22-24

42/SPV7 1 000420097
42-42MP: 8-10-11-13-14-17-19
55-55MP: 6x7-8x9-10x11-12x13
14x15-16x17-18x19

42/SPV11 1 000420100
42-42MP: 8-9-10-11-12-13
14-15-16-17-19
142-142SN: 8-9-10-11-12-13
14-15-16-17-19

42/SPV15 1 000420102
42-42MP: 6-7-8-9-10-11-12-13
14-15-16-17-19-22-24

42AS

combination wrenches,
open and offset ring ends



mm	L mm		
1/4x1/4	95	5	000420106
5/16x5/16	116	5	000420108
3/8x3/8	137	5	000420110
7/16x7/16	148	5	000420111
1/2x1/2	169	5	000420113
9/16x9/16	180	5	000420114
5/8x5/8	201	5	000420116
11/16x11/16	212	5	000420117
3/4x3/4	233	5	000420119
13/16x13/16	254	5	000420121
7/8x7/8	264	5	000420122
15/16x15/16	285	2	000420124
1x1	296	2	000420125

mm	L mm		
1.1/16x1.1/16	317	2	000420127
1.1/8x1.1/8	338	2	000420129
1.1/4x1.1/4	370	2	000420132
1.5/16x1.5/16	391	1	000420133
1.3/8x1.3/8	412	1	000420135
1.7/16x1.7/16	412	1	000420136
1.1/2x1.1/2	433	1	000420138



42AS/B9 1 000420155
1/4-5/16-3/8-7/16-1/2
9/16-5/8-11/16-3/4



42AS/13 1 000420163
1/4-5/16-3/8-7/16-1/2-9/16
5/8-11/16-3/4-13/16-7/8
15/16-1

42MP

combination wrenches, open and offset
ring ends, bright chrome-plated



UNI/ISO 7738 DIN 3113

mm	L mm		
6x6	95	5	000420606
7x7	105	5	000420607
8x8	116	5	000420608
9x9	127	5	000420609
10x10	137	5	000420610
11x11	148	5	000420611
12x12	158	5	000420612
13x13	169	5	000420613
14x14	180	5	000420614
15x15	190	5	000420615
16x16	201	5	000420616
17x17	212	5	000420617
18x18	222	5	000420618
19x19	233	5	000420619
20x20	243	3	000420620
21x21	254	3	000420621
22x22	264	3	000420622
24x24	285	3	000420624
27x27	317	3	000420627
30x30	349	3	000420630
32x32	370	3	000420632



42MP/B9 1 000420651
6-7-8-10-11-13-14-17-19

42/BV9 1 000420056



42MP/S17 1 000420652
6-7-8-9-10-11-12-13-14
15-16-17-18-19-20-21-22

42MP/S21 1 000420653
6-7-8-9-10-11-12-13-14
15-16-17-18-19-20-21-22
24-27-30-32

42MP/AS

combination wrenches, open and offset
ring ends, bright chrome-plated



mm	L mm		
1/4x1/4	95	3	000420666
5/16x5/16	116	3	000420668
3/8x3/8	137	3	000420670
7/16x7/16	148	3	000420671
1/2x1/2	169	3	000420673
9/16x9/16	180	3	000420674
5/8x5/8	201	3	000420676
11/16x11/16	212	3	000420677
3/4x3/4	233	3	000420679
13/16x13/16	271	2	000420680
7/8x7/8	295	2	000420681
15/16x15/16	317	2	000420682
1x1	339	2	000420683
1.1/16x1.1/16	362	2	000420684
1.1/8x1.1/8	394	2	000420685
1.1/4x1.1/4	429	2	000420686



42MPAS/9 1 000420693
1/4-5/16-3/8-7/16-1/2
9/16-5/8-11/16-3/4

42MPAS/13 1 000420694
1/4-5/16-3/8-7/16-1/2
9/16-5/8-11/16-3/4
13/16-7/8-15/16-1



42LMP

combination wrenches, open and offset ring ends, long series, bright chrome-plated



mm	L mm		
8x8	148	5	000420508
9x9	167	5	000420509
10x10	172	5	000420510
11x11	186	5	000420511
12x12	197	5	000420512
13x13	207	5	000420513
14x14	223	5	000420514
15x15	233	5	000420515
16x16	243	5	000420516
17x17	261	5	000420517
18x18	270	5	000420518
19x19	280	5	000420519
21x21	301	3	000420521
22x22	318	3	000420522
24x24	338	3	000420524
27x27	376	3	000420527
30x30	394	3	000420530
32x32	435	3	000420532



42LMP/S14	1	000420551
8-9-10-11-12-13-14		
15-16-17-18-19-21-22		
42LMP/S18	1	000420552
8-9-10-11-12-13-14		
15-16-17-18-19-21-22		
24-27-30-32		

45

combination wrenches, open and offset ring ends, heavy series



UNI/ISO 7738 DIN 3113

mm	L mm		
46x46	520	1	000450046
50x50	560	1	000450050
55x55	610	1	000450055
60x60	660	1	000450060
65x65	710	1	000450065
70x70	760	1	000450070
75x75	810	1	000450075
80x80	860	1	000450080



52

single open end wrenches



UNI 6733 DIN 3114

mm	L mm		
10	120	5	000520010
11	120	5	000520011
12	120	5	000520012
13	145	5	000520013
14	145	5	000520014
15	145	5	000520015
16	160	5	000520016
17	160	5	000520017
18	160	5	000520018
19	175	5	000520019
20	175	5	000520020
21	175	5	000520021
22	195	2	000520022
23	195	2	000520023
24	195	2	000520024
25	215	2	000520025
26	215	2	000520026
27	215	2	000520027
28	240	2	000520028
30	240	2	000520030
32	270	2	000520032
34	270	1	000520034
35	295	1	000520035
36	295	1	000520036
38	295	1	000520038
40	335	1	000520040
41	335	1	000520041
42	335	1	000520042
45	370	1	000520045
46	370	1	000520046
48	370	1	000520048
50	415	1	000520050
52	415	1	000520052
55	415	1	000520055
60	490	1	000520060
65	490	1	000520065
70	490	1	000520070

53

single open end wrenches DIN 894



mm	L mm		
19	178	5	000530019
22	219	5	000530022
24	219	5	000530024
27	241	5	000530027
30	267	5	000530030
32	285	5	000530032
36	317	1	000530036
38	320	1	000530038
41	342	1	000530041
46	396	1	000530046
50	412	1	000530050
55	457	1	000530055
60	492	1	000530060
65	528	1	000530065
70	572	1	000530070
75	608	1	000530075
80	645	1	000530080
85	690	1	000530085

mm	L mm		
90	690	1	000530090
95	847	1	000530095
100	847	1	000530100
105	1000	1	000530105
110	1000	1	000530110
115	1000	1	000530115
120	1000	1	000530120
125	1000	1	000530125
130	1000	1	000530130
135	1000	1	000530135

55

double open end wrenches



UNI 10102 DIN 3110

mm	L mm		
4x5	100	10	000550003
5x5,5	100	10	000550006
5,5x7	120	10	000550009
6x7	120	10	000550012
7x8	140	10	000550018
8x9	140	10	000550021
8x10	140	10	000550024
10x11	155	10	000550030
10x12	155	10	000550033
10x13	170	10	000550035
12x13	170	10	000550042
12x14	170	10	000550045
13x14	185	10	000550047
13x17	189	10	000550051
14x15	185	10	000550054
14x17	189	10	000550057
16x17	202	10	000550060
17x19	220	5	000550063
18x19	220	5	000550066
19x22	236	5	000550069
20x22	236	5	000550075
21x23	245	5	000550078
22x24	245	5	000550081
24x26	262	5	000550087
24x27	262	5	000550090
25x28	272	5	000550096
27x29	284	5	000550099
27x30	284	5	000550102
27x32	295	5	000550105
30x32	295	5	000550108
32x36	325	1	000550114
34x36	325	1	000550117
35x38	375	1	000550120
36x41	375	1	000550123
41x46	425	1	000550129
46x50	475	1	000550132
50x55	500	1	000550135
55x60	500	1	000550138





55/B6	1	000550150
6x7-8x9-10x11-12x13 14x15-16x17		
55/BV6	1	000550151
55/B8	1	000550158
6x7-8x9-10x11-12x13 14x15-16x17-18x19 20x22		
55/BV8	1	000550159
55/B12	1	000550162
6x7-8x9-10x11-12x13 14x15-16x17-18x19 20x22-21x23-24x26 25x28-30x32		
55/BV12	1	000550163



55/S8	1	000550174
6x7-8x9-10x11-12x13 14x15-16x17-18x19 20x22		
55/S12	1	000550178
6x7-8x9-10x11-12x13 14x15-16x17-18x19 20x22-21x23-24x26 25x28-30x32		
55/S12X	1	000550179
6x7-8x9-10x11-12x13 14x15-16x17-18x19 20x22-21x23-24x27 25x28-30x32		
55/S13	1	000550182
6x7-8x9-10x11-12x13 14x15-16x17-18x19 20x22-21x23-24x26 25x28-27x29-30x32		



55/SP7



55/SP13

55/SP7	1	000550167
6x7-8x9-10x11-12x13 14x15-16x17-18x19		
42/SPV7	1	000420097
42-42MP: 8-10-11-13-14-17-19 55-55MP: 6x7-8x9-10x11-12x13 14x15-16x17-18x19		
55/SP13	1	000550186
6x7-8x9-10x11-12x13 14x15-16x17-18x19 20x22-21x23-24x26 25x28-27x29-30x32		
55/SPV	1	000550190

55AS

double open end wrenches



$\frac{mm}{mm}$	L mm	$\frac{mm}{mm}$	$\frac{mm}{mm}$
1/4x9/32	120	5	000550203
1/4x5/16	120	5	000550206
5/16x11/32	140	5	000550209
5/16x3/8	140	5	000550212
3/8x7/16	155	5	000550215
7/16x1/2	170	5	000550218
1/2x9/16	170	5	000550221
9/16x5/8	185	5	000550224
19/32x11/16	189	2	000550227
5/8x11/16	202	2	000550230
5/8x3/4	202	2	000550233
11/16x13/16	220	2	000550242
3/4x7/8	236	2	000550245
25/32x13/16	236	2	000550244
7/8x15/16	245	2	000550251
15/16x1	262	1	000550257
1x1.1/8	272	1	000550259
1.1/16x1.1/4	295	1	000550267
1.1/8x1.5/16	295	1	000550266
1.5/16x1.1/2	325	1	000550269
1.3/8x1.1/2	375	1	000550272
1.7/16x1.5/8	375	1	000550275



55AS/5	1	000550290
5/16x11/32-3/8x7/16 1/2x9/16-5/8x11/16 3/4x7/8		
55AS/7	1	000550295
5/16x11/32-3/8x7/16 1/2x9/16-5/8x3/4 11/16x13/16 7/8x15/16-1.1/8x1.5/16		
55AS/11	1	000550300
1/4x9/32-5/16x11/32 3/8x7/16-1/2x9/16 19/32x11/16-5/8x3/4 25/32x13/16-7/8x15/16 1x1.1/8-1.1/16x1.1/4 1.1/8x1.5/16		

55MP

double open end wrenches,
bright chrome-plated



UNI 10102 DIN 3110

$\frac{mm}{mm}$	L mm	$\frac{mm}{mm}$	$\frac{mm}{mm}$
6x7	120	2	000550603
8x9	140	2	000550606
10x11	155	2	000550609
12x13	170	2	000550612
14x15	185	2	000550615
16x17	202	2	000550618
18x19	220	2	000550621
20x22	236	2	000550624
21x23	245	2	000550627
24x26	262	3	000550630
25x28	272	3	000550633
27x29	284	3	000550636
30x32	295	3	000550639



55MP/S8	1	000550650
6x7-8x9-10x11-12x13 14x15-16x17-18x19 20x22		
55MP/S13	1	000550651
6x7-8x9-10x11-12x13 14x15-16x17-18x19 20x22-21x23-24x26 25x28-27x29-30x32		

58

open end slogging wrenches



DIN 133

$\frac{mm}{mm}$	L mm	$\frac{mm}{mm}$	$\frac{mm}{mm}$
27	180	1	000580027
30	190	1	000580030
32	190	1	000580032
36	215	1	000580036
41	235	1	000580041
46	255	1	000580046
50	275	1	000580050
55	300	1	000580055
60	320	1	000580060
65	342	1	000580065
70	375	1	000580070
75	375	1	000580075
80	408	1	000580080
85	408	1	000580085
90	445	1	000580090
95	445	1	000580095
100	485	1	000580100
105	485	1	000580105
110	510	1	000580110
115	510	1	000580115
120	545	1	000580120
125	545	1	000580125
130	575	1	000580130
135	575	1	000580135
140	575	1	000580140
145	640	1	000580145
150	640	1	000580150
155	640	1	000580155
160	640	1	000580160
165	715	1	000580165
170	715	1	000580170
175	715	1	000580175
180	715	1	000580180
185	715	1	000580185
190	800	1	000580190
195	800	1	000580195
200	800	1	000580200
210	800	1	000580210
220	800	1	000580220
230	800	1	000580230

73

small double open end wrenches



UNI 6737

mm	L mm		
4x4	78	5	000730040
4,5x4,5	78	5	000730045
5x5	78	5	000730050
5,5x5,5	86	5	000730055
6x6	86	5	000730060
7x7	86	5	000730070
8x8	97	5	000730080
9x9	97	5	000730090
10x10	108	5	000730100
11x11	108	5	000730110
12x12	124	5	000730120
13x13	124	5	000730130
14x14	124	5	000730140



73/B13	1	000730200
4-4,5-5-5,5-6-7-8-9		
10-11-12-13-14		
73/BV	1	000730201



73/S13	1	000730210
4-4,5-5-5,5-6-7-8-9		
10-11-12-13-14		

78

ring slotting wrenches



DIN 7444

mm	L mm		
24	163	1	000780024
27	180	1	000780027
30	190	1	000780030
32	190	1	000780032
36	205	1	000780036
41	230	1	000780041
46	240	1	000780046
50	255	1	000780050
55	270	1	000780055
60	280	1	000780060
65	300	1	000780065
70	330	1	000780070
75	330	1	000780075
80	360	1	000780080
85	360	1	000780085

mm	L mm		
90	390	1	000780090
95	390	1	000780095
100	420	1	000780100
105	420	1	000780105
110	450	1	000780110
115	450	1	000780115
120	480	1	000780120
125	480	1	000780125
130	520	1	000780130
135	520	1	000780135
140	520	1	000780140
145	580	1	000780145
150	580	1	000780150
155	580	1	000780155
160	580	1	000780160
165	650	1	000780165
170	650	1	000780170
175	650	1	000780175
180	650	1	000780180
185	700	1	000780185
190	700	1	000780190
195	700	1	000780195
200	700	1	000780200
210	750	1	000780210
215	750	1	000780215
220	750	1	000780220
230	750	1	000780230

80

double swivel end socket wrenches



mm	L mm		
6x7	173	3	000800006
8x9	176	3	000800008
8x10	179	3	000800009
10x11	182	3	000800010
12x13	228	3	000800012
14x15	232	3	000800014
13x17	231	3	000800015
16x17	234	3	000800016
18x19	285	3	000800018
19x22	287	3	000800019
20x22	289	3	000800020
21x23	289	3	000800021
24x27	405	3	000800024
30x32	413	3	000800030

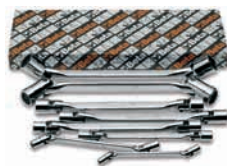

80/S8	1	000800051
6x7-8x9-10x11-12x13-14x15		
16x17-18x19-20x22		
80/S11	1	000800056
6x7-8x9-10x11-12x13		
14x15-16x17-18x19-20x22		
21x23-24x27-30x32		

83

half-moon ring wrenches



ISO 3318

mm	L mm		
8x10	126	5	000830008
10x12	137	5	000830010
11x13	138	5	000830011
14x17	183	5	000830014
15x17	184	3	000830015
16x18	196	3	000830016
19x22	230	3	000830019



83/S3	1	000830081
11x13-14x17-19x22		
83/S5	1	000830085
10x12-11x13-15x17		
16x18-19x22		

83AS

half-moon ring wrenches



mm	L mm		
7/16x1/2	138	5	000830111
9/16x5/8	183	5	000830114
3/4x7/8	230	3	000830119



83AS/3	1	000830181
7/16x1/2-9/16x5/8		
3/4x7/8		



90

double ended deep offset ring wrenches



UNI 6740 DIN 838 ISO 10104

mm	L mm		
6x7	165	5	000900006
8x9	180	5	000900012
8x10	180	5	000900015
10x11	195	5	000900018
10x12	195	5	000900021
11x13	215	5	000900024
12x13	215	5	000900027
12x14	215	5	000900030
14x15	230	5	000900033
14x17	245	5	000900036
16x17	245	5	000900039
17x19	265	5	000900042
18x19	265	5	000900045
19x22	290	5	000900048
20x22	290	5	000900051
21x23	300	3	000900057
22x24	300	3	000900060
24x26	325	3	000900063
24x27	325	3	000900067
25x28	340	3	000900070
27x29	355	3	000900073
27x30	355	3	000900076
27x32	365	3	000900078
30x32	375	3	000900080
32x36	380	1	000900088
34x36	380	1	000900089
35x38	445	1	000900091
36x41	445	1	000900094
41x46	490	1	000900097
46x50	520	1	000900100



90/B8 1 000900154

6x7-8x9-10x11-12x13
14x15-16x17-18x19
20x22

90/BV8 1 000900155

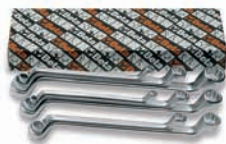

90/S8 1 000900162

6x7-8x9-10x11-12x13
14x15-16x17-18x19
20x22

90/S12 1 000900166

6x7-8x9-10x11-12x13
14x15-16x17-18x19
20x22-21x23-24x26
25x28-30x32

90/S12X 1 000900167

6x7-8x9-10x11-12x13
14x15-16x17-18x19
20x22-21x23-24x27
25x28-30x32

90/S13 1 000900170

6x7-8x9-10x11-12x13
14x15-16x17-18x19
20x22-21x23-24x26
25x28-27x29-30x32



90/SP13

6x7-8x9-10x11-12x13
14x15-16x17-18x19
20x22-21x23-24x26
25x28-27x29-30x32

1 000900174

55/SPV 1 000550190

90AS

double ended deep offset ring wrenches



mm	L mm		
1/4x5/16	165	2	000900203
5/16x11/32	180	2	000900206
5/16x3/8	180	2	000900209
3/8x7/16	195	2	000900212
7/16x1/2	215	2	000900215
1/2x9/16	215	2	000900218
9/16x5/8	230	2	000900221
5/8x11/16	245	2	000900224
5/8x3/4	265	2	000900227
11/16x3/4	265	1	000900230
11/16x13/16	265	1	000900233
3/4x7/8	290	1	000900237
13/16x7/8	290	1	000900240
7/8x15/16	300	1	000900243
15/16x1	325	1	000900252
1.1/16x1.1/4	365	1	000900258
1.1/8x1.5/16	365	1	000900261

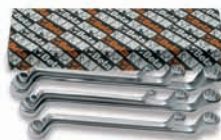

90AS/8 1 000900298

1/4x5/16-5/16x11/32
3/8x7/16-1/2x9/16
5/8x11/16-11/16x3/4
13/16x7/8-15/16x1

90AS/10 1 000900300

1/4x5/16-5/16x11/32
3/8x7/16-1/2x9/16
5/8x11/16-11/16x3/4
13/16x7/8-15/16x1
1.1/16x1.1/4-1.1/8x1.5/16



91

heavy duty offset ring wrenches



mm	D mm		
24	38	1	000910024
27	41	1	000910027
30	48	1	000910030
32	49	1	000910032
36	54	1	000910036
41	62	1	000910041
46	69	1	000910046
50	76	1	000910050
55	81	1	000910055
60	90	1	000910060
65	98	1	000910065
70	105	1	000910070
75	110	1	000910075
80	125	1	000910080
85	125	1	000910085
90	140	1	000910090
95	140	1	000910095
100	143	1	000910100
105	146	1	000910105

92

tubes for item 91



	L mm	91 mm		
92/1	460	24÷30	1	000920010
92/2	610	32÷41	1	000920020
92/3	760	46÷55	1	000920030
92/4	860	60÷105	1	000920040

93

double-ended offset ring wrench for scaffolding bolts



mm	L mm		
21x22	310	3	000930021

93C

ratcheting double-ended offset ring wrenches for scaffolding bolts



mm	L mm		
17x19	315	1	000930117
19x22	315	1	000930119
19x24	360	1	000930120
21x22	315	1	000930121

94

flare nut open ring wrenches



DIN 3118

mm	L mm		
8x10	150	3	000940008
9x11	150	3	000940009
10x11	155	3	000940010
11x13	165	3	000940011
12x14	190	3	000940012
14x15	190	2	000940014
14x17	197	2	000940015
17x19	215	2	000940017
19x22	230	2	000940019
22x24	245	2	000940022
24x27	260	2	000940024
30x32	288	2	000940030
36x41	320	1	000940036



94/S6 1 000940050
8x10-10x11-11x13-12x14
17x19-19x22

94/S10 1 000940052
8x10-9x11-10x11-11x13
12x14-17x19-19x22
22x24-24x27-30x32

94AS

flare nut open ring wrenches



mm	L mm		
5/16x3/8	150	3	000940108
3/8x7/16	155	3	000940112
7/16x1/2	165	3	000940115
1/2x9/16	190	3	000940118
9/16x5/8	200	2	000940121
5/8x3/4	215	2	000940124
3/4x7/8	230	2	000940130



94AS/7 1 000940152
5/16x3/8-3/8x7/16
7/16x1/2-1/2x9/16
9/16x5/8-5/8x3/4
3/4x7/8

95

double ended flat ring wrenches



DIN 837 ISO 10103

mm	L mm		
6x7	120	5	000950161
8x9	135	5	000950162
10x11	150	5	000950163
12x13	165	5	000950164
14x15	185	5	000950165
16x17	210	5	000950166
17x19	225	5	000950167
18x19	225	5	000950168
20x22	240	5	000950169
21x23	255	5	000950170
24x26	270	5	000950171
25x28	285	5	000950172
27x29	315	5	000950173
30x32	335	5	000950174



95/S8 1 000950177
6x7-8x9-10x11-12x13
14x15-16x17-18x19
20x22

95/S13 1 000950179
6x7-8x9-10x11-12x13
14x15-16x17-18x19
20x22-21x23-24x26
25x28-27x29-30x32

95P

double ended angle head wrenches



DIN 837 ISO 10103

mm	L mm		
6x7	120	5	000950185
8x9	135	5	000950186
10x11	150	5	000950187
12x13	165	5	000950188
14x15	185	5	000950189
16x17	210	5	000950190
18x19	225	5	000950191
20x22	240	5	000950192
21x23	255	5	000950193
24x26	270	5	000950194
25x28	285	5	000950195
27x29	315	5	000950196
30x32	335	5	000950197



95P/S8 1 000950200
6x7-8x9-10x11-12x13
14x15-16x17-18x19
20x22

95P/S13 1 000950202
6x7-8x9-10x11-12x13
14x15-16x17-18x19
20x22-21x23-24x26
25x28-27x29-30x32

95FTX

double-ended straight wrenches, for Torx® head screws



	L mm		
E6xE8	115	3	000950306
E10xE12	143	3	000950310
E14xE18	177	3	000950314
E20xE24	224	3	000950320



95FTX/S4 1 000950325
E6xE8-E10xE12
E14xE18-E20xE24

96

offset hexagon key wrenches chrome-plated



UNI 6753 DIN 911 ISO 2936

mm	L mm	L1 mm		
1,5	45	15	20	000960015
2	50	17	20	000960020
2,5	57	20	20	000960025
3	64	22	20	000960030
3,5	68	25	20	000960035
4	72	28	20	000960040
4,5	78	30	20	000960045
5	83	32	20	000960050
6	94	37	20	000960060
7	99	40	10	000960070
8	105	43	10	000960080
9	111	46	10	000960090
10	119	49	10	000960100
11	126	52	10	000960110
12	134	56	10	000960120
13	142	62	10	000960130
14	151	69	10	000960140
16	165	75	5	000960160
17	174	79	5	000960170

mm	L mm	L1 mm		
19	196	88	5	000960190
22	216	100	3	000960220
24	242	112	1	000960240
27	271	125	1	000960270
30	309	140	1	000960300
32	341	155	1	000960312
36	385	174	1	000960316



96/ST6
2,5-3-4-5-6-8

3 000960370



96/PL7
2,5-3-4-5-6-8-10

1 000960371



96/B8
2-2,5-3-4-5-6-8-10

5 000960386

96/B10
1,5-2-2,5-3-4-5-6-8-10-12

5 000960380

96/BV
1 000960651



96/SP9
1,5-2-2,5-3-4-5-6-8-10

5 000960384

96BP/SPV
1 000960982



96/SP12
2-2,5-3-3,5-4-4,5-5
6-7-8-9-10

1 000960390

96/SPV
1 000960400

96N

offset hexagon key wrenches,
burnished



UNI 6753 DIN 911 ISO 2936

mm	L mm	L1 mm		
0,9	32	10	20	000960409
1,3	44	12	20	000960413
1,5	46	15	20	000960415
2	51	17	20	000960420
2,5	57	20	20	000960425
3	64	22	20	000960430
3,5	68	25	20	000960435
4	72	28	20	000960440
4,5	78	30	20	000960445
5	83	32	20	000960450
6	94	37	20	000960460
7	99	40	10	000960470
8	105	43	10	000960480
9	111	46	10	000960490
10	119	49	10	000960500
11	126	52	10	000960510
12	134	56	10	000960520
13	142	62	10	000960530
14	151	69	10	000960540
16	165	72	5	000960560
17	174	79	5	000960570
19	196	88	5	000960590



96N/ST6
2,5-3-4-5-6-8

3 000960640



96N/G7
2,5-3-4-5-6-8-10

4 000960645

96N/G7A
1,5-2-2,5-3-4-5-6

4 000960643



96N/B10
1,5-2-2,5-3-4-5-6
8-10-12

5 000960650

96N/BV
1 000960651



96N/SP9
1,5-2-2,5-3-4-5-6-8-10

5 000960658

96BP/SPV
1 000960982



96N/SP12
2-2,5-3-3,5-4-4,5-5
6-7-8-9-10

1 000960660

96N/SPV
1 000960665

96AS

offset hexagon key wrenches,
burnished



	L mm	L1 mm		
1/30	44	14	20	000960698
1/20	44	15	20	000960701
1/16	46	16	20	000960702
5/64	50	18	20	000960704
3/32	53	19	20	000960706
7/64	57	21	20	000960708
1/8	60	22	20	000960710
9/64	64	24	20	000960712
5/32	68	25	20	000960714
3/16	75	29	20	000960716
7/32	82	32	20	000960718
1/4	89	35	20	000960720
5/16	103	40	10	000960724
3/8	117	44	10	000960728
7/16	132	49	10	000960730
1/2	149	54	10	000960732



96AS/T7
3/32-1/8-5/32
3/16-7/32-1/4-5/16

3 000960740



96AS/G7
3/32-1/8-5/32
3/16-1/4-5/16-3/8

3 000960745



96AS/PL7
3/32-1/8-5/32-3/16
1/4-5/16-3/8

1 000960746



96AS/B11
1/20-1/16-5/64-3/32
1/8-5/32-3/16-7/32
1/4-5/16-3/8

1 000960749

96N/BV 1 000960651

96LC

offset hexagon key wrenches,
long series, chrome-plated



mm	L mm	L1 mm		
2	101	17	20	000960320
2,5	113	20	20	000960321
3	127	22	20	000960322
3,5	138	25	20	000960323
4	142	28	20	000960324
4,5	154	28	20	000960325
5	163	32	20	000960326
6	184	37	20	000960327
7	194	40	10	000960328
8	205	43	10	000960329
9	216	46	10	000960330
10	231	49	10	000960331
12	259	56	10	000960332



96LC/SP8
2-2,5-3-4-5-6-8-10
96BP/SPV

2 000960335
1 000960982



96LC/SP12
2-2,5-3-3,5-4-4,5-5
6-7-8-9-10
96L/SPV

1 000960336
1 000960928

96L

offset hexagon key wrenches,
long series, burnished



mm	L mm	L1 mm		
2	99	15	20	000960820
2,5	110	17	20	000960825
3	124	19	20	000960830
3,5	135	21	20	000960835
4	138	24	20	000960840
4,5	150	25	20	000960845
5	158	27	20	000960850
6	178	31	20	000960860
7	187	33	10	000960870
8	197	35	10	000960880
9	207	37	10	000960890
10	221	39	10	000960900
12	247	44	10	000960920



96L/SP8
2-2,5-3-4-5-6-8-10
96BP/SPV

2 000960925
1 000960982



96L/SP12
2-2,5-3-3,5-4-4,5-5
6-7-8-9-10
96L/SPV

1 000960927
1 000960928

96BPC

ball head offset hexagon key wrenches
chrome-plated



mm	L mm	L1 mm		
1,5	79	13	10	000960340
2	84	15	10	000960341
2,5	89	17	10	000960342
3	99	19	10	000960343
4	108	24	10	000960344
5	126	27	10	000960345
6	148	31	10	000960346
7	157	33	5	000960353
8	168	35	5	000960347
10	187	39	5	000960348



96BPC/SP9
1,5-2-2,5-3-4-5-6-8-10
96BP/SPV

1 000960351
1 000960982

96BP

ball head offset hexagon key wrenches
burnished

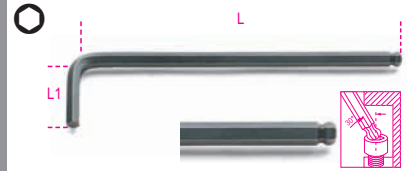

mm	L mm	L1 mm		
1,5	79	13	10	000960960
2	84	15	10	000960961
2,5	89	17	10	000960962
3	99	19	10	000960963
4	108	24	10	000960965
5	126	27	10	000960967
6	148	31	10	000960968
8	168	35	5	000960970
10	187	39	5	000960972



96BP/SP9
1,5-2-2,5-3-4-5-6-8-10
96BP/SPV

1 000960980
1 000960982

96BP/AS

ball head offset hexagon wrenches
burnished

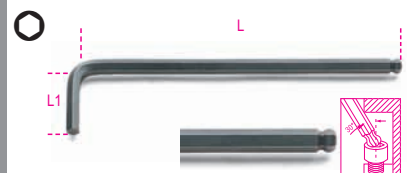

	L mm	L1 mm		
3/32	89	17	10	000960989
1/8	98	18	10	000960990
5/32	108	24	10	000960991
3/16	126	26	10	000960992
7/32	139	28	10	000960993
1/4	152	31	10	000960994
5/16	168	34	5	000960995
3/8	190	39	5	000960996



96BP/AS8
3/32-1/8-5/32-3/16-7/32
1/4-5/16-3/8
96BP/ASBV

1 000960997
1 000960998

96T

offset hexagon key wrenches,
with high torque handles

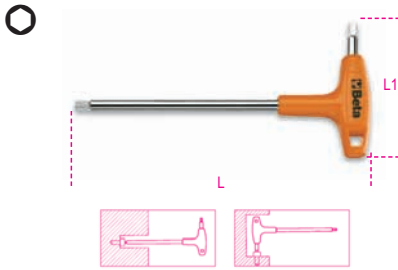

mm	L mm	L1 mm		
2	139	52	5	000960934
2,5	153	55	5	000960935
3	153	55	5	000960936
3,5	179	70	5	000960937
4	179	70	5	000960938
4,5	200	84	5	000960939
5	200	84	5	000960940
6	220	95	5	000960941
7	236	106	5	000960942
8	255	114	5	000960943
10	285	132	5	000960945



96T/S5 3-4-5-6-8	1	000960949
96T/S7 2,5-3-3,5-4-4,5-5-6	1	000960950



96T/SP11 2-2,5-3-3,5-4-4,5-5 6-7-8-10	1	000960957
96T/SPV	1	000960958

96T/AS

offset hexagon key wrenches,
with high torque handles

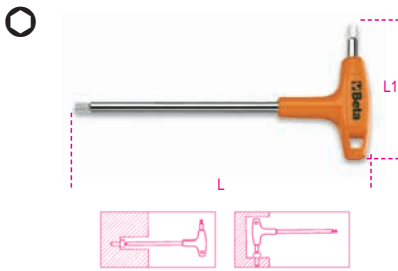

	L mm	L1 mm		
3/32	153	40	2	000960669
7/64	153	40	2	000960670
1/8	179	53	2	000960671
9/64	179	53	2	000960672
5/32	200	64	2	000960673
3/16	200	64	2	000960674
7/32	220	71	2	000960675
1/4	236	78	2	000960676
5/16	255	78	2	000960678
3/8	285	85	2	000960680



96TAS/10 3/32-7/64-1/8-9/64-5/32 3/16-7/32-1/4-5/16-3/8	1	000960683
--	---	-----------

96TBP

ball head offset hexagon key wrenches
with high torque handles

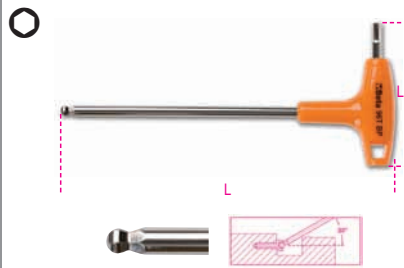

mm	L mm	L1 mm		
2,5	153	55	5	000960685
3	153	55	5	000960686
4	179	70	5	000960687
5	200	84	5	000960688
6	220	95	5	000960689
8	255	114	5	000960690



96TBP/S5 2,5-3-4-5-6	1	000960695
--------------------------------	---	-----------

97TX

offset key wrenches,
for Torx® head screws



	L mm	L1 mm		
T6	42	16	5	000970006
T7	48	16	5	000970007
T8	48	16	5	000970008
T9	48	16	5	000970009
T10	51	17	5	000970010
T15	54	18	5	000970015
T20	57	19	5	000970020
T25	60	20	5	000970025
T27	64	21	5	000970027
T30	70	24	5	000970030
T40	76	26	5	000970040
T45	83	29	5	000970045
T50	95	32	5	000970050
T55	108	35	5	000970055
T60	120	38	5	000970060



97TX/ST8 T9-T10-T15-T20-T25 T27-T30-T40	3	000970640
--	---	-----------



97TX/G8 T9-T10-T15-T20-T25 T27-T30-T40	3	000970645
---	---	-----------



97TX/PL8 T9-T10-T15-T20-T25 T27-T30-T40	1	000970371
--	---	-----------



97TX/SP8 T9-T10-T15-T20-T25 T27-T30-T40	3	000970061
97SPV	1	000970300



97TX/B13 T6-T7-T8-T9-T10-T15-T20 T25-T27-T30-T40-T45-T50	1	000970650
---	---	-----------

96N/BV	1	000960651
---------------	---	-----------

Beta



97BTX

ball head offset key wrenches,
for Torx® head screws

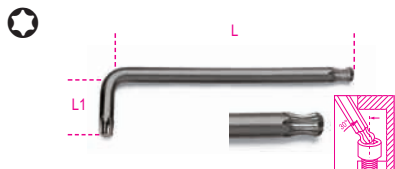

	L mm	L1 mm		
T9	64	16	5	000970109
T10	73	17	5	000970110
T15	83	17	5	000970115
T20	94	18	5	000970120
T25	96	18	5	000970125
T27	106	20	5	000970127
T30	119	24	5	000970130
T40	132	26	5	000970140
T45	137	29	5	000970145
T50	140	32	3	000970150
T55	145	35	3	000970155



97BTX/SP8
T9-T10-T15-T20-T25
T27-T30-T40

2 000970161

97/SPV 1 000970300



97BTX/B8
T9-T10-T15-T20-T25
T27-T30-T40

1 000970159

96N/BV 1 000960651

97RTX

offset key wrenches
for Tamper Resistant Torx® head screws



	L mm	L1 mm		
T9	56	16	5	000970209
T10	62	17	5	000970210
T15	72	17	5	000970215
T20	83	18	5	000970220
T25	90	18	5	000970225
T27	100	20	5	000970227
T30	105	24	5	000970230
T40	112	26	5	000970240



97RTX/SP8
T9-T10-T15-T20-T25

T27-T30-T40

97/SPV

3 000970261

1 000970300



97RTX/B8
T9-T10-T15-T20-T25

T27-T30-T40

96N/BV

1 000970260

1 000960651

97TTX

offset key wrenches with handles
for Torx® head screws

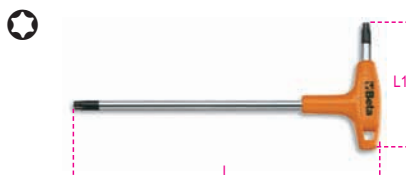

	L mm	L1 mm		
T8	139	52	5	000970708
T9	139	52	5	000970709
T10	153	55	5	000970710
T15	153	55	5	000970715
T20	179	70	5	000970720
T25	179	70	5	000970725
T27	200	84	5	000970727
T30	200	84	5	000970730
T40	220	95	5	000970740
T45	236	106	3	000970745
T50	236	106	3	000970750



97TTX/S11
8-9-10-15-20-25

27-30-40-45-50

1 000970800



97TTX/SP11
8-9-10-15-20-25

27-30-40-45-50

96T/SPV

1 000970840

1 000960958

98XZN

offset key wrenches with XZN® profile



	L mm	L1 mm		
M5	72	25	5	000980005
M6	80	28	5	000980006
M8	90	32	5	000980008
M10	100	36	5	000980010
M12	112	40	5	000980012
M14	125	45	5	000980014
M16	140	55	5	000980016



98XZN/G5
M5-M6-M8-M10-M12

3 000980645



98XZN/B5
M5-M6-M8-M10-M12

1 000980650

96N/BV 1 000960651

99

hook wrenches with square noses,
for ring nuts UNI/ISO 2982, 2983



UNI 6752

	B mm		
12-14	1,0	5	000990012
16-18-20	1,3	5	000990016
22-25-28	1,7	5	000990022
30-32	1,8	5	000990030
34-36-38	1,9	5	000990034
40-42	1,9	5	000990040
45-50	1,9	5	000990045
52-55-58	1,8	5	000990052
62-65	2,4	5	000990062
68-70-75	2,4	5	000990068
80-85-90	3,0	3	000990080
92-95	3,5	3	000990092
98-100	3,5	3	000990098
105-110-115	3,5	3	000990105
120-125-130	4,0	3	000990120
135-145	5,0	1	000990135
155-165	6,0	1	000990155

99SQ

hook wrenches with square noses
for ring nuts



mm	B mm		
15-35	2,7	3	000990215
35-50	3,5	3	000990235
50-80	4,7	3	000990250
80-120	6,2	2	000990280
120-180	7,8	2	000990290

99ST

hook wrenches with round noses
for ring nuts



mm	B mm	∅ mm		
15-35	2,5	3	3	000990315
35-50	3,5	4	3	000990335
50-80	5,0	5	3	000990350
80-120	7,0	6	2	000990380
120-180	9,0	8	2	000990390

99 VN/...

spare nose for item 99ST

	mm		
99VN/15	15-35	1	000990295
99VN/35	35-50	1	000990296
99VN/50	50-80	1	000990297
99VN/80	80-120	1	000990298
99VN/120	120-180	1	000990299

100

round pin wrench for ring nuts
with front holes



∅ mm	L mm		
4,9-5,9	250	1	001000001
6,9-7,9			

100/KIT

spare pins for item 100



100/KIT		1	001000010
---------	--	---	-----------

111

adjustable wrenches with scales, chrome-plated

- Right-hand rotation of pin
- With mm and inch scale



DIN 3117 ISO 6787

L mm	A max		
100	15	5	001110010
150	22	5	001110015
200	28	5	001110020
250	32	5	001110025
300	35	3	001110030
380	45	3	001110038
450	54	2	001110045
600	62	1	001110060

111N

adjustable wrenches with scales,
phosphatized

- Left-hand rotation of pin
- With mm and inch scale



DIN 3117 ISO 6787

L mm	A max		
100	15	5	001110210
150	22	5	001110215
200	28	5	001110220
250	32	5	001110225
300	35	3	001110230
380	45	3	001110238
450	54	2	001110245

120

ratchet opening single ended
bi-hex wrenches



∅ mm	L mm		
10	135	2	001200010
11	135	2	001200011
12	135	2	001200012
13	135	2	001200013
14	135	2	001200014
17	185	2	001200017
19	185	2	001200019
22	230	1	001200022
24	230	1	001200024
27	230	1	001200027
30	320	1	001200030
32	320	1	001200032



120/B6		1	001200050
10-11-13			
17-19-22			

120/BV		1	001200051
--------	--	---	-----------

123E1/4

bit holder adaptor, 1/4", for 10 mm ratcheting
wrenches

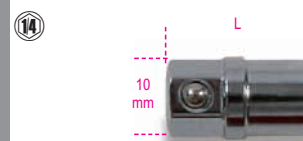

∅ mm	L mm		
10	17,5	1	001230010

123Q1/4

quick release adaptor, 1/4", for 10 mm
ratcheting wrenches

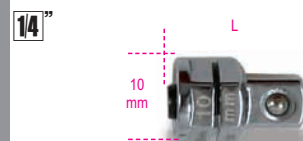

∅ mm	L mm		
10	17,5	1	001230310

123Q3/8

quick release adaptor, 3/8", for 13 mm
ratcheting wrenches

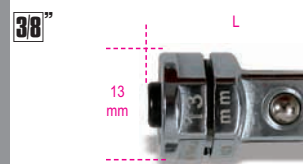

∅ mm	L mm		
13	22,5	1	001230313

123Q1/2

quick release adaptor, 1/2", for 19 mm
ratcheting wrenches

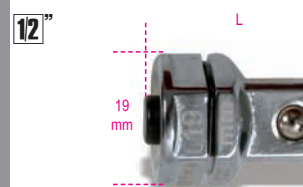

∅ mm	L mm		
19	29,5	1	001230319

123/K4

kit with 4 adapters for ratchet wrenches:
1 bit adapter
3 quick release adapters



123/K4 1 001230504

142

reversible ratcheting
combination wrenches



mm	L mm		
6x6	135	3	001420006
7x7	135	3	001420007
8x8	135	3	001420008
9x9	142	3	001420009
10x10	158	3	001420010
11x11	167	3	001420011
12x12	173	3	001420012
13x13	180	3	001420013
14x14	190	2	001420014
15x15	200	2	001420015
16x16	215	2	001420016
17x17	230	2	001420017
18x18	238	2	001420018
19x19	245	2	001420019
22x22	284	1	001420022
24x24	324	1	001420024
27x27	355	1	001420027
30x30	420	1	001420030
32x32	420	1	001420032



142/B6	8-10-13-14-17-19	1	001420066
142/BV6		1	001420076
142/B9	8-10-11-12-13-14-15-17-19	1	001420069
142/BV9		1	001420079



142/S15	6-7-8-9-10-11-12-13-14-15-16-17-18-19-22	1	001420074
142/S19	6-7-8-9-10-11-12-13-14-15-16-17-18-19-22-24-27-30-32	1	001420075

142/SC9I-E

set of 9 reversible ratcheting combination
wrenches, with compact support



142/SC9I	8-10-11-12-13-14-15-17-19	1	001420087
142/SCV9I		1	001420103
142/SC9E	8-10-11-12-13-16-17-18-19	1	001420088
142/SCV9E		1	001420104

142AS

reversible ratcheting
combination wrenches



mm	L mm		
5/16x5/16	136	2	001420308
3/8x3/8	159	2	001420310
7/16x7/16	168	2	001420311
1/2x1/2	180	2	001420313
9/16x9/16	190	2	001420314
5/8x5/8	216	2	001420316
11/16x11/16	233	2	001420317
3/4x3/4	248	2	001420319



142AS/8	5/16-3/8-7/16-1/2-9/16-5/8-11/16-3/4	1	001420330
---------	--------------------------------------	---	-----------

142C

ratcheting combination wrenches,
straight short series



mm	L mm		
8x8	88	3	001420108
9x9	96	3	001420109
10x10	96	3	001420110
11x11	99	3	001420111
12x12	103	3	001420112
13x13	107	3	001420113
14x14	113	3	001420114
15x15	117	3	001420115
16x16	121	3	001420116
17x17	127	3	001420117
18x18	131	3	001420118
19x19	137	3	001420119



142C/A12	8-9-10-11-12-13-14-15-16-17-18-19	1	001420175
----------	-----------------------------------	---	-----------

142SN

swivel end ratcheting
combination wrenches



mm	L mm		
8x8	136	2	001420208
9x9	143	2	001420209
10x10	161	2	001420210
11x11	169	2	001420211
12x12	175	2	001420212
13x13	178	2	001420213
14x14	194	2	001420214
15x15	201	2	001420215
16x16	217	2	001420216
17x17	233	2	001420217
18x18	238	2	001420218
19x19	250	2	001420219



142SN/S12	8-9-10-11-12-13-14-15-16-17-18-19	1	001420252
-----------	-----------------------------------	---	-----------

192

reversible ratcheting double-ended flat bi-hex
ring wrenches, 4 in 1



mm	L mm		
8x10/12x13	160	1	001920008
16x17/18x19	230	1	001920016



192/S2	8x10/12x13-16x17/18x19 mm	1	001920070
--------	---------------------------	---	-----------

194

reversible ratcheting wrench
for bits



Size	L mm	Qty	Part No.
1/4x5/16	128	2	001940006

195

ratcheting double-ended flat bi-hex ring
wrenches



Size	L mm	Qty	Part No.
8x10	128	2	001950010
12x13	170	2	001950013
14x15	190	2	001950015
16x18	230	2	001950018
17x19	230	2	001950019



195/B5	1	001950066
8x10-12x13-14x15		
16x18-17x19		
195/BV5	1	001950070

195P

reversible ratcheting double-ended offset
bi-hex ring wrenches, bent at 15°



Size	L mm	Qty	Part No.
8x10	128	2	001950210
12x13	170	2	001950213
14x15	190	2	001950215
16x18	230	2	001950218
17x19	230	2	001950219



195P/B5	1	001950266
8x10-12x13-14x15		
16x18-17x19		
195/BV5	1	001950070

195FTX

ratcheting double-ended flat bi-hex ring
wrenches with Torx® head



Size	L mm	Qty	Part No.
E6xE8	128	2	001950406
E10xE12	170	2	001950410
E14xE18	190	2	001950414
E20xE24	230	2	001950420



195FTX/B4	1	001950501
E6xE8-E10xE12		
E14xE18-E20xE24		
195FTX/BV4	1	001950520

310

polywelder for PE, PP, PVC
and PVDF pipes and fittings

CE



230V-650 Watt
50 Hz±60Hz
Schuko (CEE 7/7)

310/1	1	003100001
Ø 16÷50		
310/2	1	003100002
Ø 16÷63		

310B

forms for polywelder item 310

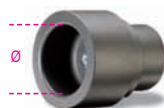

Ø mm	Qty	Part No.
16	1	003100016
20	1	003100020
25	1	003100025
32	1	003100032
40	1	003100040
50	1	003100050
63	1	003100063

310/C4

polywelder with assortment of 3 forms



310/C4	1	003100104
310/1+310B: Ø 20-25-32		
410x260x82 mm - 4,8 kg		

310/C8

polywelder with assortment of 7 forms



310/C8	1	003100108
310/2+310B: Ø 16-20-25 32-40-50-63		
440x270x120 mm - 7,7 kg		

311

heating plates for manual straight
and slanted welding of PE, PP, PVC
and PVDF pipes



Ø mm	Watt	Qty	Part No.
120	900	1	003110001
190	900	1	003110002

312A

gas welding handle



Ø	L mm	Qty	Part No.
M18x1	210	2	003120001

Beta
Collection

312B

gas welding handle with quick valve control lever



Ø	L		
mm	mm		
M18x1	210	2	003120005

312F

fork burners



A	L		
mm	mm	Kj/h	
312F/40	40 240	24611	2 003120012

312G

kit with copper bit, wind guard and burner 22 mm in diameter



L			
mm	Kj/h		
312G	180 9543	2	003120041

312G/RM

spare bits for item 312G



312G/RM	2	003120046
---------	---	-----------

312G/RC

spare wind guard for item 312G



312G/RC	2	003120047
---------	---	-----------

312BR

brass burners

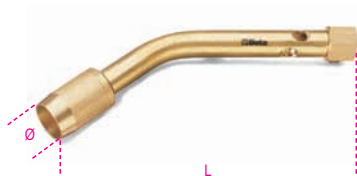

Ø	L		
mm	mm	Kj/h	
10	120	1306	2 003120051
15	160	7534	2 003120053
17	160	9041	2 003120055
20	200	25113	2 003120057
20	190	18081	2 003120059

312BR/A

steel burners



Ø	L		
mm	mm	Kj/h	
45	90	46208	2 003120145
60	110	175791	2 003120160
90	140	190859	2 003120190

312PC

curved extension bars



	L		
	mm		
312PC/20	160	2	003120220
312PC/35	350	2	003120235
312PC/60	600	2	003120260
312PC/75	750	2	003120275

330

pipe cutters for steel gas pipes



	Ø	L		
	mm	mm		
330/2	10÷60 mm 1/8"÷2" gas	380	1	003300002
330/4	60÷115 mm 2"÷4" gas	585	1	003300004

330R/A2 - 330R/A4

spare cutters for item 330 wheels for steel pipes

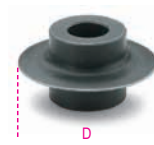

	D		
	mm		
330R/A2	32	1	003300012
330R/A4	42	1	003300014

330R/I

spare cutter wheel for item 330 for stainless steel pipes

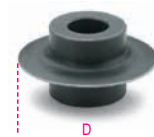

	D		
	mm		
330R/I	32	1	003300024

331L

ratcheting pipe cutter for copper and light alloy pipes



Ø	L		
mm	mm		
8÷29 mm 5/16"÷1"1/8"	180	1	003310008

332

mini pipe cutter for copper and light alloy pipes



Ø	L		
mm	mm		
3÷16 mm 1/8"÷5/8"	59	2	003320001

334

pipe cutter for copper and light alloy pipes



Ø	L		
mm	mm		
3÷30 mm 1/8"÷1"1/8"	150	1	003340001

334R

spare cutter wheel for items 332
and 334 for copper and light alloy pipes



	D mm		
334R	18,5	1	003340021

334R/I

spare cutter wheel for items 332
and 334 for stainless steel pipes



	D mm		
334R/I	18,5	1	003340023

336

telescopic pipe cutter for copper
and light alloy pipes



Ø	L mm		
6÷38 mm 1/4"÷1"1/2	160	1	003360001

338

telescopic pipe cutter, fast advance
for copper, light alloys and plastic pipes



Ø	L mm		
6÷67 mm 1/4"÷2"5/8	290	1	003380001

338R

spare cutter wheel for items 336
and 338 for copper and light alloy pipes



	D mm		
338R	18,5	1	003380022

338R/I

spare cutter wheel for items 336
and 338 for stainless steel pipes



	D mm		
338R/I	23,5	1	003380023

338RP

spare cutter wheel for items 336
and 338 for plastic pipes



	D mm		
338RP	23,5	1	003380025

339A

telescopic pipe cutter, fast advance
for plastic pipes



Ø	L mm		
50÷127 mm 2"÷5"	345	1	003390011

339A/R

spare cutter wheels for item 339A



	D mm		
339A/R	42	1	003390061

341

pipe cutting pliers for plastic pipes



Ø	L mm		
0÷25	190	1	003410001

341RL

spare blade for item 341



341RL		1	003410010

341B

ratchet-type shears for plastic pipes



Ø mm	L mm		
0÷35	195	1	003410051

341B/RM

spare spring for item 341B

341B/RM		1	003410061

341B/RL

spare blade for item 341B



341B/RL		1	003410060

342

ratchet-type shears
for plastic pipes

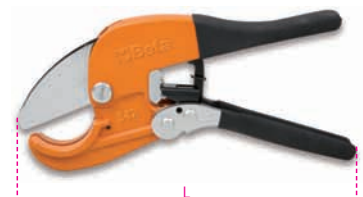

Ø max	L mm		
42 mm 1"5/8	200	1	003420030

342MOL

spare spring for item 342

342MOL		1	003420033

342RL

spare blade for item 342



342RL 1 003420032

342A

ratchet-type shears for plastic pipes



Ø mm 0÷50 L mm 270 1 003420101

342A/MOL

spare spring for item 342A

342A/MOL 1 003420111

342A/RL

spare blade for item 342A



342A/RL 1 003420110

344

tube flaring pliers for lead pipes

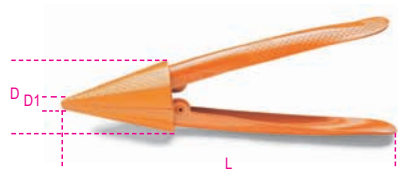

L mm 240 D mm 53 D1 mm 11 1 003440001

345

pipe reamer metal body

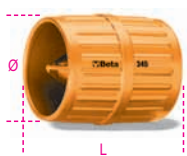

Ø mm 3÷42 mm 1/8"÷1"5/8 L mm 58 5 003450001

345SB

deburrer with revolving replacement blade



L mm 150 5 003450010

345SB/R

spare blade for item 345SB



345SB/R 3 003450015

350

tube flaring tool for copper and light alloy pipes

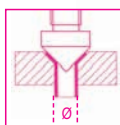

Ø mm 4-4,75-6-8-10-12-14 1 003500001

351C

pipe cutter and tube flaring tool



351C 1 003510010

334 Ø 3÷30 mm (1/8"÷1"1/8)

350 Ø 4÷14 mm

351P Ø 4-4,75-6-8-10-12-14 mm

225x150x45 mm - 1,6 kg

351P

inserts for tube flaring tool item 350



	Ø mm	
351P4	4	5 003510101
351P4,75	4,75	5 003510102
351P6	6	5 003510103
351P8	8	5 003510104
351P10	10	5 003510105
351P12	12	5 003510106
351P14	14	5 003510107

352

tube flaring tool for copper and light alloy pipes

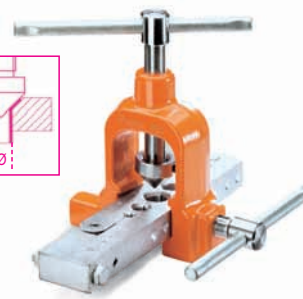
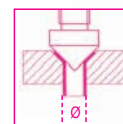

Ø mm 4,75-5-6-8-10-12-14 1 003520001

352C

pipe cutter and tube flaring tool



352C 1 003520010

334 Ø 3÷30 mm (1/8"÷1"1/8)

352 Ø 4,75÷14 mm

352P Ø 4,75x0,7-5x0,7-6x0,7-8x0,7-10x0,7 mm
Ø 4,75x1-5x1-6x1-8x1-10x1 mm

352PR

418x160x59 mm - 3,3 kg

352PR

compressor for tube flaring tool item 352



352PR 5 003520050



352P

inserts for tube flaring tool item 352

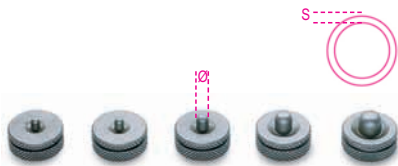

	ØxS mm		
352P1/0,7	4,75x0,7	5	003520051
352P2/0,7	5x0,7	5	003520052
352P3/0,7	6x0,7	5	003520053
352P4/0,7	8x0,7	5	003520054
352P5/0,7	10x0,7	5	003520055
352P1/1	4,75x1,0	5	003520056
352P2/1	5x1,0	5	003520057
352P3/1	6x1,0	5	003520058
352P4/1	8x1,0	5	003520059
352P5/1	10x1,0	5	003520060

352U

adjustable tube flaring tool
for copper and light alloy pipes

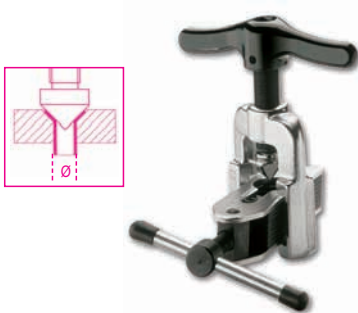

Ø "		
3/16+5/8 (5+16 mm)	1	003520101

352C/U

pipe cutter, deburrer and adjustable tube
flaring tool



352C/U	1	003520110
--------	---	-----------

334 Ø 1/8"+1"1/8 (3+30 mm)

345SB

352U Ø 3/16"+5/8" (5+16 mm)

≡ 335x145x60 mm - 2120 g

353N

tube expanding pliers,
with interchangeable forms



L mm		
380	1	003530201

353NM

forms for tube expanding pliers
item 353N



Ø mm		
10	1	003530210
12	1	003530212
14	1	003530214
16	1	003530216
18	1	003530218
22	1	003530222

353N/C6

tube expanding pliers item 353N
with forms item 353NM



353N/C6	1	003530300
---------	---	-----------

353N

353NM Ø 10-12-14-16-18-22 mm

≡ 420x185x60 mm - 2,2 kg

355

combination spud wrench, five steps

12"



Ø	L mm		
3/8"-1/2" 3/4"-1"	90	2	003550001

357

adjustable spirit level with two vials

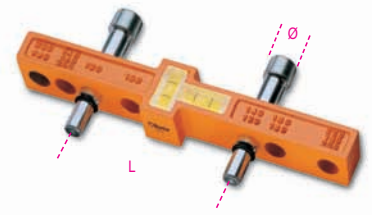

Ø 1/2"	L mm		
120+220	1	003570001	

358

tools for chamfering plastic pipes



	Ø mm		
358/1	16+110	1	003580001
358/2	40+250	1	003580002

358RL

spare blade for items 358/1 and 358/2



358RL	1	003580011
-------	---	-----------

359

universal drain wrench



Ø 1"+1"1/4	L mm		
160	1	003590001	



359CH

drain adaptor, cross-shape for item 359



Ø	L mm	
1 1/2"	74	1 003590005

360

pipe wrenches, Stillson pattern



L mm	Ø max gas	Ø max mm	
250	1" gas	34	1 003600025
350	1 1/2" gas	49	1 003600035
450	2" gas	60	1 003600045
600	2 1/2" gas	76	1 003600060
900	3 1/2" gas	102	1 003600090

360R/...

spare parts kit with jaws + ring nuts for item 360

360R/250	1 003600225
360R/350	1 003600235
360R/450	1 003600245
360R/600	1 003600260
360R/900	1 003600290

362

heavy duty pipe wrenches



L mm	Ø max gas	Ø max mm	
200	1" gas	34	1 003620020
250	1 1/2" gas	49	1 003620025
300	2" gas	60	1 003620030
350	2" gas	60	1 003620035
450	2 1/2" gas	76	1 003620045
600	3" gas	90	1 003620060

362R/...

spare parts kit for item 362

362R/200	1 003620220
362R/250	1 003620225
362R/300	1 003620230
362R/350	1 003620235
362R/450	1 003620245
362R/600	1 003620260

363

heavy duty pipe wrenches made from light alloy



L mm	Ø max gas	Ø max mm	
350	2" gas	60	1 003630035
450	2 1/2" gas	76	1 003630045
600	3" gas	90	1 003630060
900	5" gas	140	1 003630090

363R/...

spare parts kit for item 363

363R/350	1 003630235
363R/450	1 003630245
363R/600	1 003630260
363R/900	1 003630290

365

heavy duty pipe wrenches, offset pattern made from light alloy

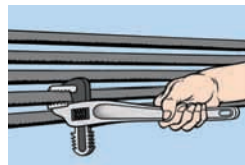

L mm	Ø max gas	Ø max mm	
350	2" gas	60	1 003650035
450	2 1/2" gas	76	1 003650045

365R/...

full spare parts kit for item 365

365R/350	1 003650235
365R/450	1 003650245

366

pipe wrenches, light pattern



L mm	Ø max gas	Ø max mm	
175	1" gas	34	1 003660017
225	1 1/2" gas	49	1 003660022
275	2" gas	60	1 003660027
300	2 1/2" gas	76	1 003660030
350	3" gas	90	1 003660035

374

pipe wrenches, Swedish pattern, 45° slim jaws



L ~	Ø max gas	Ø max mm	
240	1/2" gas	21	1 003740024
320	1" gas	34	1 003740032
410	1 1/2" gas	49	1 003740041
550	2" gas	60	1 003740055
630	3" gas	90	1 003740063

375

pipe wrench, Swedish pattern, 45° flat jaws



L ~	Ø max gas	Ø max mm	
320	1" gas	34	1 003750032
410	1 1/2" gas	49	1 003750041
550	2" gas	60	1 003750055

376

pipe wrenches, Swedish pattern, 90° flat jaws



L ~	Ø max gas	Ø max mm	
320	1" gas	34	1 003760032
410	1 1/2" gas	49	1 003760041
550	2" gas	60	1 003760055
630	3" gas	90	1 003760063

378

pipe wrenches, Swedish pattern, 45° slim jaws



L ~	Ø max gas	Ø max mm	
250	1/2" gas	21	1 003780025
320	1" gas	34	1 003780032
410	1 1/2" gas	49	1 003780041
550	2" gas	60	1 003780055
650	3" gas	90	1 003780065

374R/...

full spare parts kit for items 374 - 376 - 378

374R/240	1 003740724
x 374/240-378/250	
374R/320	1 003740732
x 374/320-376/320-378/320	
374R/410	1 003740741
x 374/410-376/410-378/410	
374R/550	1 003740755
x 374/550-376/550-378/550	
374R/630	1 003740763
x 374/630-378/650	

383

reversible strip pipe wrenches



	∅ max	∅ max mm		
383/1	3" gas	90	2	003830001
383/2	8" gas	220	2	003830002

383R

spare strips for item 383



	S mm		
383R/1 x 383/1	27	1	003830010
383R/2 x 383/2	27	1	003830015

384

reversible chain pipe wrench



	∅ max	∅ max mm		
4" gas		115	1	003840032

384RC

spare chain for item 384



384RC	1	003840033
-------	---	-----------

386A

heavy duty reversible chain pipe wrenches



	∅	L mm		
386A/3	4" gas 115 mm	900	1	003860003
386A/4	6" gas 168 mm	900	1	003860004
386A/5	8" gas 220 mm	1100	1	003860005
386A/6	12" gas 324 mm	1300	1	003860006

386A/RC

spare chains for item 386A



386A3/RC x 386A/3	1	003860013
386A4/RC x 386A/4	1	003860014
386A5/RC x 386A/5	1	003860015
386A6/RC x 386A/6	1	003860016

388

pipe benders for thin walled copper, light alloy and mild steel pipes

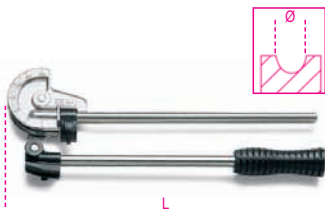

∅ mm	L mm		
6	305	1	003880006
8	315	1	003880008
10	350	1	003880010
12	360	1	003880012
14	455	1	003880014
15	465	1	003880015
16	465	1	003880016

388A

pipe bending pliers for thin walled copper and light alloy pipes



	∅		
388A/1	6-8-10 mm	1	003880051
388A/2	1/4"-5/16"-3/8"	1	003880055

392A

adjustable drain tap pliers



∅ mm	L mm		
14+62	235	1	003920001

392A/RG

spare jaw protectors for item 392A



392A/RG	1	003920051
---------	---	-----------

393

water tap wrench

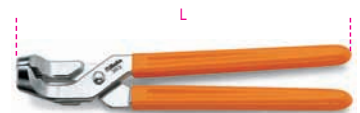

L mm		
270	2	003930001

395

hinged water tap wrench



∅	L mm		
15+32 mm 5/8"±1"1/4	240	2	003950001

395T

telescopic hinged water tap wrench



∅	L mm		
395T 10+32 mm 3/8"±1"1/4	250+430	2	003950100



395KS

T-handle hexagon wrenches

36"



395KS	L mm	1	003950121
	250		

399

pivoting clamp vices

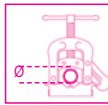

Ø	L min mm	1	003990005
10÷60 mm 1/8÷2"	220		
10÷89 mm 1/8÷3"	290		003990010

410

twist drills with cylindrical shanks,
short series HSS, rolled



DIN 338 ISO 235

Ø mm	L mm	10	004100030
0,50	22		
1,00	34		
1,25	38		
1,50	40		
1,75	46		
2,00	49		
2,25	53		
2,50	57		
2,75	61		
3,00	61		
3,20	65		
3,25	65		
3,50	70		
3,75	70		
4,00	75		
4,20	75		
4,25	75		
4,50	80		
4,75	80		
5,00	86		
5,25	86		
5,50	93		
5,75	93		
6,00	93		
6,25	101		
6,50	101		
6,75	109		

Ø mm	L mm	10	004100112
7,00	109		
7,50	109		
8,00	117		
8,50	117		
9,00	125		
9,50	125		
10,00	133		
10,50	133		
11,00	142		
11,50	142		
12,00	151		
12,50	151		
13,00	151		
14,00	160		
15,00	169		
16,00	178		
17,00	186		
18,00	194		
19,00	202		
20,00	210		



410/SP19	1	004100419
Ø 1÷10 x 0,5 mm		
410/SPV1	1	004100420
410/SP25	1	004100425
Ø 1÷13 x 0,5 mm		
410/SPV2	1	004100426



410/SEL19	1	004100418
Ø 1÷10 x 0,5 mm		

410MIX/SEL19

set of 13 twist drills, item 410,
and 6 twist drills with hard metal insets



410MIX/SEL19	1	004100417
--------------	---	-----------

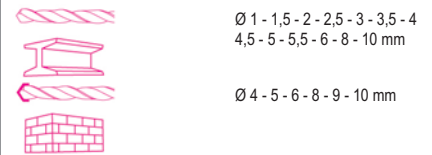

410A

twist drills with cylindrical shanks,
short series, HSS, rolled



DIN 338 ISO 235

Ø mm	L mm	5	004100281
13,50	108		
14,00	108		
14,50	114		
15,00	114		
15,50	120		
16,00	120		
16,50	125		
17,00	125		
17,50	130		
18,00	130		
18,50	135		
19,00	135		
19,50	140		
20,00	140		

410AS

twist drills with cylindrical shanks,
short series HSS, rolled



ANSI B94

Ø "	L mm	10	004100371
1/16	48		
5/64	51		
3/32	57		
7/64	67		
1/8	70		
9/64	73		
5/32	79		
11/64	83		
3/16	89		



Ø "	L mm		
13/64	92	10	004100380
7/32	95	10	004100381
15/64	98	10	004100382
1/4	102	10	004100383
17/64	105	10	004100384
9/32	108	10	004100385
19/64	111	10	004100386
5/16	114	10	004100387
21/64	117	10	004100388
11/32	121	5	004100389
23/64	124	5	004100390
3/8	127	5	004100391



410AS/SP21

Ø 1/16-5/64-3/32-7/64
1/8-9/64-5/32-11/64-3/16
13/64-7/32-15/64-1/4
17/64-9/32-19/64-5/16
21/64-11/32-23/64-3/8

410AS/SPV1

1 004100429

1 004100430



410AS/SEL21

Ø 1/16-5/64-3/32-7/64
1/8-9/64-5/32-11/64-3/16
13/64-7/32-15/64-1/4
17/64-9/32-19/64-5/16
21/64-11/32-23/64-3/8

1 004100433

412

twist drills with cylindrical shanks,
short series HSS entirely ground glossy
finishing



DIN 338 ISO 235

Ø mm	L mm		
0,50	22	10	004120030
1,00	34	10	004120040
1,25	38	10	004120043
1,50	40	10	004120046
1,75	46	10	004120049

Ø mm	L mm		
2,00	49	10	004120052
2,25	53	10	004120055
2,50	57	10	004120058
2,75	61	10	004120061
3,00	61	10	004120064
3,25	65	10	004120067
3,50	70	10	004120070
3,75	70	10	004120073
4,00	75	10	004120076
4,25	75	10	004120079
4,50	80	10	004120082
4,75	80	10	004120085
5,00	86	10	004120088
5,25	86	10	004120091
5,50	93	10	004120094
5,75	93	10	004120097
6,00	93	10	004120100
6,25	101	10	004120103
6,50	101	10	004120106
6,75	109	10	004120109
7,00	109	10	004120112
7,25	109	5	004120115
7,50	109	5	004120118
7,75	117	5	004120121
8,00	117	5	004120124
8,25	117	5	004120127
8,50	117	5	004120130
8,75	125	5	004120133
9,00	125	5	004120136
9,25	125	5	004120139
9,50	125	5	004120142
9,75	133	5	004120145
10,00	133	5	004120148
10,25	133	5	004120149
10,50	133	5	004120150
10,75	142	5	004120151
11,00	142	5	004120152
11,25	142	5	004120153
11,50	142	5	004120154
11,75	142	5	004120155
12,00	151	5	004120156
12,25	151	5	004120157
12,50	151	5	004120158
12,75	151	5	004120159
13,00	151	5	004120160



412/SP19	Ø 1÷10 x 0,5 mm	1	004120419
412/SPV1		1	004120420
412/SP25	Ø 1÷13 x 0,5 mm	1	004120425
412/SPV2		1	004120426
412/SP49	Ø 1÷13 x 0,25 mm	1	004120449
412/SPV4		1	004120451

412/C150



412/C150 1 004120450

412 Ø 3 mm
Ø 1 - 1,5 - 2 - 2,5 - 3,5 - 4 - 4,5 - 5 mm
Ø 5,5 - 6 - 6,5 - 7 - 7,5 - 8 - 8,5 - 9 - 9,5 - 10 mm

365x230x47 mm - 3390 g



412/SP91 1 004120452

Ø 1÷10 x 0,10 mm

412A

twist drills with cylindrical shanks,
short series, HSS entirely ground
burnished



DIN 338 ISO 235

Ø mm	L mm		
13,50	160	3	004120202
14,00	160	3	004120204
14,50	169	3	004120206
15,00	169	3	004120208
15,50	178	3	004120210
16,00	178	3	004120212
16,50	186	1	004120213
17,00	186	1	004120214
17,50	194	1	004120215
18,00	194	1	004120216
18,50	202	1	004120217
19,00	202	1	004120218
19,50	210	1	004120219
20,00	210	1	004120220

412L

twist drills with cylindrical shanks, long series, HSS entirely ground burnished



DIN 340 ISO 494

Ø mm	L mm		
2,00	85	10	004120232
2,50	95	10	004120234
3,00	100	10	004120236
3,50	112	10	004120238
4,00	119	10	004120240
4,50	126	10	004120242
5,00	132	10	004120244
5,50	139	10	004120246
6,00	139	10	004120248
6,50	148	5	004120250
7,00	156	5	004120252
8,00	165	5	004120256
9,00	175	5	004120260
10,00	184	5	004120264

414

twist drills with cylindrical shanks, short series, HSS-TiN entirely ground



DIN 338 ISO 235

Ø mm	L mm		
1,00	34	10	004140040
1,25	38	10	004140042
1,50	40	10	004140046
1,75	46	10	004140048
2,00	49	10	004140052
2,25	53	10	004140054
2,50	57	10	004140058
2,75	61	10	004140060
3,00	61	10	004140064
3,25	65	10	004140066
3,50	70	10	004140070
3,75	70	10	004140072
4,00	75	10	004140076
4,25	75	10	004140078
4,50	80	10	004140082
4,75	80	10	004140084
5,00	86	10	004140088
5,25	86	10	004140090
5,50	93	10	004140094
5,75	93	10	004140096
6,00	93	10	004140100
6,25	101	10	004140102
6,50	101	10	004140106
6,75	109	10	004140108
7,00	109	10	004140112
7,25	109	5	004140114
7,50	109	5	004140118
7,75	117	5	004140120
8,00	117	5	004140124
8,25	117	5	004140125
8,50	117	5	004140130
8,75	125	5	004140132
9,00	125	5	004140136
9,25	125	5	004140138
9,50	125	5	004140142
9,75	133	5	004140144
10,00	133	5	004140148

Ø mm	L mm		
10,50	133	5	004140150
11,00	142	5	004140152
11,50	142	5	004140154
12,00	151	5	004140156
12,50	151	5	004140158
13,00	151	5	004140160



414/SP19 Ø 1÷10 x 0,5 mm	1	004140419
414/SPV1	1	004140420
414/SP25 Ø 1÷13 x 0,5 mm	1	004140425
414/SPV2	1	004140426
414/SP49 Ø 1÷13 x 0,25 mm	1	004140429
414/SPV4	1	004140430

414/C116



414/C116	1	004140450
-----------------	---	-----------

414	Ø 1 - 1,5 - 2 - 2,5 - 3 - 3,5 - 4 - 4,5 - 5 mm	10
	Ø 5,5 - 6 - 6,5 - 7 - 7,5 - 8 mm	3
	Ø 8,5 - 9 - 9,5 - 10 mm	2

365x230x47 mm - 2680 g

415

twist drills with cylindrical shanks, short series, HSS-CO 8% entirely ground



DIN 338 ISO 235

Ø mm	L mm		
0,50	22	10	004150029
1,00	34	10	004150040
1,25	38	10	004150043
1,50	40	10	004150046
1,75	46	10	004150049
2,00	49	10	004150052
2,25	53	10	004150055
2,50	57	10	004150058

Ø mm	L mm		
2,75	61	10	004150061
3,00	61	10	004150064
3,25	65	10	004150067
3,50	70	10	004150070
3,75	70	10	004150073
4,00	75	10	004150076
4,25	75	10	004150079
4,50	80	10	004150082
4,75	80	10	004150085
5,00	86	10	004150088
5,25	86	10	004150091
5,50	93	10	004150094
5,75	93	10	004150097
6,00	93	10	004150100
6,25	101	10	004150103
6,50	101	10	004150106
6,75	109	10	004150109
7,00	109	10	004150112
7,25	109	5	004150115
7,50	109	5	004150118
7,75	117	5	004150121
8,00	117	5	004150124
8,25	117	5	004150127
8,50	117	5	004150130
8,75	125	5	004150133
9,00	125	5	004150136
9,25	125	5	004150139
9,50	125	5	004150142
9,75	133	5	004150145
10,00	133	5	004150148
10,25	133	5	004150149
10,50	133	5	004150150
10,75	142	5	004150151
11,00	142	5	004150152
11,25	142	5	004150153
11,50	142	5	004150154
11,75	142	5	004150155
12,00	151	5	004150156
12,25	151	5	004150157
12,50	151	5	004150158
12,75	151	5	004150159
13,00	151	5	004150160
14,00	160	3	004150164
15,00	169	3	004150168
16,00	178	3	004150172
17,00	186	1	004150174
18,00	194	1	004150176
19,00	202	1	004150178
20,00	210	1	004150180



415/SP19 Ø 1÷10 x 0,5 mm	1	004150419
415/SPV1	1	004150420
415/SP25 Ø 1÷13 x 0,5 mm	1	004150425
415/SPV2	1	004150426
415/SP49 Ø 1÷13 x 0,25 mm	1	004150431
415/SPV4	1	004150432

415/C116



415/C116 1 004150450

415	Ø	n.
	1 - 1,5 - 2 - 2,5 - 3 - 3,5 - 4 - 4,5 - 5 mm	10
	Ø 5,5 - 6 - 6,5 - 7 - 7,5 - 8 mm	3
	Ø 8,5 - 9 - 9,5 - 10 mm	2

365x230x47 mm - 2680 g



415/SP91 1 004150460
Ø 1÷10 x 0,10 mm

416

drill with cylindrical shank, specially ground, with two cutter pairs



HIGHER CUTTING CAPACITY



DIN 338

Ø mm	L mm	
1,00	34	10 004160010
1,50	40	10 004160015
2,00	49	10 004160020
2,50	57	10 004160025
3,00	61	10 004160030
3,50	70	10 004160035
4,00	75	10 004160040
4,50	80	10 004160045
5,00	86	10 004160050
5,50	93	10 004160055
6,00	93	10 004160060
6,50	101	10 004160065
7,00	109	10 004160070
7,50	109	5 004160075
8,00	117	5 004160080
8,50	117	5 004160085
9,00	125	5 004160090
9,50	125	5 004160095
10,00	133	5 004160100

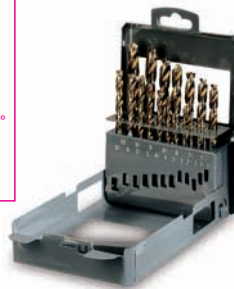
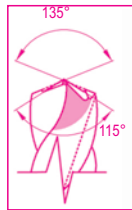

416/SP19 1 004160419
Ø 1÷10 x 0,5 mm

417

helical cylindrical masonry drill bits, short series, made from milled steel with hard metal plates



DIN 8039

Ø mm	L mm	
3	70	10 004170003
4	75	10 004170004
5	85	10 004170005
5L	150	5 004170105
6	100	10 004170007
6L	150	5 004170106
7	120	10 004170009
8	120	10 004170010
8L	200	5 004170113
9	120	10 004170011
10	120	10 004170012
10L	200	5 004170120
12	150	10 004170014
12L	200	5 004170125
14	150	5 004170016
16	150	5 004170018



417/SP8 1 004170100
Ø 3-4-5-6-8-9-10-12 mm

419

hammer drill bits with milled shanks and hard metal plates



DIN 8039

ØxL mm	
4x110	10 004190002
5x110	10 004190004
5x160	10 004190006
6x110	10 004190012
6x160	10 004190014
6x210	10 004190016
7x160	10 004190028
8x110	10 004190030
8x160	10 004190032
8x210	10 004190034
8x260	10 004190036
8x460	10 004190042
9x160	5 004190044
10x160	5 004190050
10x210	5 004190052
10x260	5 004190054
10x310	5 004190056
10x460	5 004190060
12x160	5 004190064
12x210	5 004190066
12x260	5 004190068
12x460	5 004190074
14x160	3 004190086
14x260	3 004190090
14x310	3 004190092
14x460	3 004190096
16x210	3 004190112
16x250	3 004190114
16x300	3 004190116
16x450	3 004190120
18x250	1 004190124
20x310	1 004190128

423

special end mills for welding HSS ground



Ø mm	L mm	
6	66	10 004230006
7	74	10 004230007
8	79	10 004230008
10	89	10 004230010

423A

special mills for spot welding, HSS ground



Ø mm	L mm	
6,5	40	1 004230015
8,0	40	1 004230020

424

conical drill bits, HSS



	L mm	Ø mm		
424/1	58	3÷14	3	004240001
424/2	63	6÷20	3	004240002
424/3	60	16÷30	3	004240003
424/4	80	3÷22	1	004240004
424/5	102	3÷31	1	004240005
424/6	86	26÷40	1	004240006
424/7	89	36÷50	1	004240007
424/8	90	40÷61	1	004240008



424/SP3	1	004240019
424/1+424/2+424/3		
Ø 3÷30 mm		
424/SPV	1	004240020

425

stepped drills, HSS

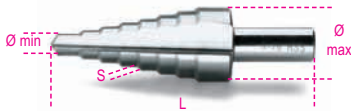

	L mm	Ø mm	S mm		
425/1	70	4÷12	1	2	004250010
425/2	55	4÷12	2	2	004250012
425/3	85	4÷20	2	2	004250015
425/4	85	12÷20	1	2	004250016
425/5	97	20÷30	1	2	004250017
425/6	75	4÷30	2	2	004250020
425/7	97	30÷40	1	2	004250025
425/8	100	40÷50	1	2	004250029



425/SP3	1	004250030
425/1+425/3+425/6		
Ø 4÷30 mm		
425/SPV	1	004250035

426

countersinking cutters
with three cutters, HSS



GR	Ø mm	L mm		
1	4,3	44	5	004260001
2	5,3	44	5	004260002
3	6,3	44	5	004260003
4	7,3	44	5	004260004
5	8,3	50	5	004260005
6	9,4	50	5	004260006
7	10,4	54	5	004260007
8	12,4	54	5	004260008
9	15,0	56	5	004260009
10	16,5	60	5	004260010
11	20,5	63	5	004260011
12	25,0	66	5	004260012
13	28,0	71	5	004260013
14	31,0	71	5	004260014



426/SP6	1	004260030
GR 3-5-7-8-10-11		
Ø 6,3÷20,5 mm		
426/SPV	1	004260035

426SB

countersinking cutters, HSS



	L mm	Ø mm		
426/SB1	45	10 - (2÷5)	1	004260101
426/SB2	48	14 - (5÷10)	1	004260102
426/SB3	65	21 - (10÷15)	1	004260103
426/SB4	85	28 - (15÷20)	1	004260104
426/SB5	102	35 - (20÷25)	1	004260105
426/SB6	115	44 - (25÷30)	1	004260106



426SB/SP4	1	004260130
426/SB1-426/SB2		
426/SB3-426/SB4		
Ø 2÷20 mm		
426SB/SPV1	1	004260135

426MD

rotary files, made from hard metal

cross cut HM4



	L mm	Ø2 mm		
426MD/CP8	63	8	1	004260512
426MD/CP12	70	12	1	004260522
426MD/CT8	63	8	1	004260513
426MD/CT12	70	12	1	004260523
426MD/F8	63	8	1	004260514
426MD/F12	70	12	1	004260524
426MD/T8	63	8	1	004260516
426MD/T12	70	12	1	004260526
426MD/S8	52	8	1	004260518
426MD/S12	55	12	1	004260528
426MD/FA8	63	8	1	004260519
426MD/FA12	70	12	1	004260529



426MD/SP10	1	004260510
426MD/CP-426MD/CT-426MD/F		
426MD/T-426MD/S		
Ø 8-12 mm		

Beta



427

Morse taper extractors



DIN 317

GR	L mm		
0	92	5	004270000
1-2	140	5	004270002
3	190	5	004270003
4	225	3	004270004
5-6	260	3	004270006

428FP

machine taps for clearance holes,
coarse pitch threads, HSS

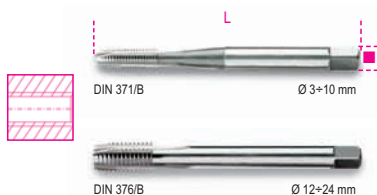

ISO 529

M	mm	L mm		
3x0,5	2,7	56	10	004280003
4x0,7	3,4	63	10	004280004
5x0,8	4,9	70	10	004280005
6x1	4,9	80	10	004280006
8x1,25	6,2	90	10	004280008
10x1,5	8,0	100	10	004280010
12x1,75	7,0	110	5	004280012
14x2	9,0	110	5	004280014
16x2	9,0	110	5	004280016
18x2,5	11,0	125	3	004280018
20x2,5	12,0	140	3	004280020
22x2,5	14,5	140	3	004280022
24x3	14,5	160	3	004280024

428FC

machine taps for blind holes,
coarse pitch threads, HSS



ISO 529

M	mm	L mm		
3x0,5	2,7	56	10	004280103
4x0,7	3,4	63	10	004280104
5x0,8	4,9	70	10	004280105
6x1	4,9	80	10	004280106
8x1,25	6,2	90	10	004280108
10x1,5	8,0	100	10	004280110
12x1,75	7,0	110	5	004280112
14x2	9,0	110	5	004280114
16x2	9,0	110	5	004280116
18x2,5	11,0	125	3	004280118
20x2,5	12,0	140	3	004280120
22x2,5	14,5	140	3	004280122
24x3	14,5	160	3	004280124

428/C14

assortment of 14 machine taps
items 428FP + 428FC



1 004280201

428/C14
428FP M3÷12
428FC M3÷12

428/SPV 1 004280202

429FP

machine taps for clearance holes,
coarse pitch threads HSS-CO 5%



ISO 529

M	mm	L mm		
3x0,5	2,7	56	5	004290003
4x0,7	3,4	63	5	004290004
5x0,8	4,9	70	5	004290005
6x1	4,9	80	5	004290006
8x1,25	6,2	90	5	004290008
10x1,5	8,0	100	5	004290010
12x1,75	7,0	110	5	004290012
14x2	9,0	110	5	004290014

429FC

machine taps for blind holes,
coarse pitch threads HSS-CO 5%



ISO 529

M	mm	L mm		
3x0,5	2,7	56	5	004290103
4x0,7	3,4	63	5	004290104
5x0,8	4,9	70	5	004290105
6x1	4,9	80	5	004290106
8x1,25	6,2	90	5	004290108
10x1,5	8,0	100	5	004290110
12x1,75	7,0	110	5	004290112
14x2	9,0	110	5	004290114

429/C14

assortment of 14 machine taps
items 429FP + 429FC



1 004290201

429/C14
429FP M3÷12
429FC M3÷12

429/SPV 1 004290202

430

hand taps, **coarse pitch**, metric thread
made from chrome-steel



DIN 352 ISO 529

M	mm	L mm		
2x0,4	2,5	36	5	004300002
3x0,5	2,5	40	5	004300003
4x0,7	3,0	45	5	004300004
5x0,8	4,0	48	5	004300005
6x1	5,0	50	5	004300006
7x1	4,5	50	5	004300007
8x1,25	5,0	56	3	004300008
9x1,25	5,5	63	3	004300009
10x1,5	6,0	70	3	004300010
11x1,5	7,0	70	3	004300011
12x1,75	7,0	75	3	004300012
14x2	8,0	80	3	004300014
16x2	10,0	80	3	004300016
18x2,5	11,0	95	1	004300018
20x2,5	12,0	95	1	004300020
22x2,5	14,5	100	1	004300022
24x3	14,5	110	1	004300024



1 004300201

430/SP21
M 3-4-5-6-8-10-12

430/SPV 1 004300202

430ASW

hand taps, **Whitworth** thread
made from chrome-steel



WHITWORTH

DIN 352

BSW	mm	L mm		
1/8x40	2,7	40	5	004300031
5/32x32	3,4	45	5	004300032
3/16x24	4,3	48	5	004300033
1/4x20	4,9	50	5	004300034
5/16x18	4,9	56	3	004300035
3/8x16	5,5	70	3	004300036
7/16x14	6,2	70	3	004300037
1/2x12	7,0	75	3	004300038
9/16x12	9,0	80	1	004300039
5/8x11	9,0	80	1	004300040
3/4x10	11,0	95	1	004300041
7/8x9	14,5	100	1	004300042
1"x8	16,0	110	1	004300043

430ASC

hand taps, **UNC** thread
made from chrome-steel



UNC

ANSI B1.1

UNC	mm	L mm		
1/4x20	4,9	70	5	004300051
5/16x18	4,9	70	5	004300052
3/8x16	5,5	75	3	004300053
7/16x14	6,2	80	3	004300054
1/2x13	7,0	85	3	004300055
9/16x12	9,0	90	3	004300056
5/8x11	9,0	100	3	004300057
3/4x10	11,0	110	3	004300058
7/8x9	14,5	120	1	004300059
1"x8	16,0	130	1	004300060

431

hand taps, **coarse pitch**,
metric thread HSS



DIN 352 UNI 4535

M	mm	L mm		
3x0,5	2,5	40	5	004310003
4x0,7	3,0	45	5	004310004
5x0,8	4,0	48	5	004310005
6x1	5,0	50	5	004310006
7x1	5,0	50	5	004310007
8x1,25	5,0	56	3	004310008
10x1,5	6,0	70	3	004310010
12x1,75	7,0	75	3	004310012
14x2	9,0	80	1	004310014
16x2	9,0	80	1	004310016
18x2,5	11,0	95	1	004310018
20x2,5	12,0	95	1	004310020
22x2,5	12,0	100	1	004310022
24x3	14,5	110	1	004310024



431/SP21	M 3-4-5-6-8-10-12	1	004310201
431/SPV		1	004310202

433

hand taps, **fine pitch**, metric thread
made from chrome-steel



DIN 2181 UNI 4535

M	mm	L mm		
6x0,75	4,5	48	5	004330201
7x0,75	4,5	56	5	004330202
8x0,75	5,0	50	5	004330203
8x1	5,0	56	5	004330204
9x0,75	6,0	63	5	004330205
9x1	6,0	63	5	004330206
10x0,75	6,5	63	5	004330207
10x1	6,5	63	5	004330208
10x1,25	6,5	63	5	004330209
11x0,75	7,0	70	3	004330210
11x1	7,0	70	3	004330211
11x1,25	7,0	70	3	004330212

M	mm	L mm		
12x0,75	7,0	70	3	004330213
12x1	7,0	70	3	004330214
12x1,25	7,0	70	3	004330215
12x1,5	7,0	70	3	004330216
14x1	8,0	80	1	004330217
14x1,25	8,0	80	1	004330218
14x1,5	8,0	80	1	004330219
16x1	10,0	80	1	004330220
16x1,5	10,0	80	1	004330221
18x1,5	11,0	95	1	004330222
18x2	11,0	80	1	004330223
20x1,5	14,5	80	1	004330224
22x1,5	14,5	80	1	004330225
24x1,5	14,5	80	1	004330226
24x2	14,5	80	1	004330227

433ASF

hand taps, **fine pitch**, UNF thread
made from chrome-steel

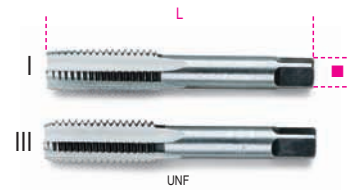

UNF

ANSI B1.1

UNF	mm	L mm		
1/4x28	4,9	70	5	004330301
5/16x24	4,9	70	5	004330302
3/8x24	5,5	75	3	004330303
7/16x20	6,2	80	3	004330304
1/2x20	7,0	85	3	004330305
9/16x18	9,0	90	3	004330306
5/8x18	9,0	100	3	004330307
3/4x16	11,0	110	3	004330308
7/8x14	14,5	120	1	004330309
1"x12	16,0	130	1	004330310

433ASG

hand taps, cylindrical **GAS** (BSP) thread
made from chrome-steel

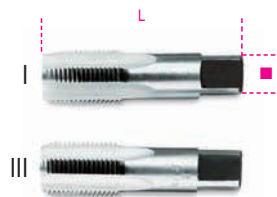

DIN 353 UNI 338

GAS	mm	L mm		
1/8x28	4,9	65	1	004330401
1/4x19	5,5	70	1	004330402
3/8x19	6,2	75	1	004330403
1/2x14	7,0	80	1	004330405
3/4x14	9,0	90	1	004330408
1"x11	11,0	100	1	004330410

Beta



Beta



434

hand taps, **fine pitch**, metric thread HSS



DIN 2181 UNI 4535

M	■ mm	L mm		
6x0,75	4,5	48	5	004340001
8x0,75	5,0	56	5	004340003
8x1	5,0	56	5	004340004
10x0,75	6,5	63	5	004340007
10x1	6,5	63	5	004340008
10x1,25	6,5	63	5	004340009
12x1	7,0	70	3	004340014
12x1,25	7,0	70	3	004340015
12x1,5	7,0	70	3	004340016
13x1,5	9,0	70	1	004340017
14x1	9,0	70	1	004340018
14x1,25	9,0	70	1	004340019
14x1,5	9,0	70	1	004340020
15x1,5	9,0	70	1	004340021
16x1	9,0	70	1	004340022
16x1,5	9,0	70	1	004340023
18x1,5	11,0	80	1	004340024
18x2	11,0	90	1	004340025
20x1,25	12,0	80	1	004340026
20x1,5	12,0	80	1	004340027
20x2	12,0	90	1	004340028
22x1,5	14,5	80	1	004340029
24x1	14,5	80	1	004340030
24x1,5	14,5	80	1	004340031
24x2	14,5	80	1	004340032

434ASF

hand taps, **fine pitch**, UNF thread HSS

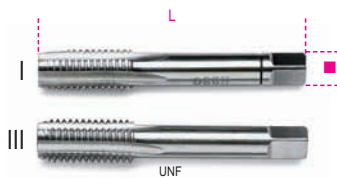

DIN 2181

UNF	■ mm	L mm		
NR 6x40	3,0	40	1	004340301
NR 8x36	4,9	40	1	004340302
NR 10x32	4,9	45	1	004340303
NR 12x28	4,9	50	1	004340304
1/4x28	4,9	50	1	004340305
5/16x24	4,9	56	1	004340306
3/8x24	5,5	63	1	004340307
7/16x20	6,2	63	1	004340308
1/2x20	7,0	75	1	004340309
9/16x18	9,0	80	1	004340310
5/8x18	9,0	80	1	004340311
3/4x16	11,0	95	1	004340312
7/8x14	14,5	100	1	004340313
1"x12	16,0	110	1	004340314

434ASG

hand taps, cylindrical **GAS** (BSP) thread, HSS



DIN 5157

GAS	■ mm	L mm		
1/8x28	5,5	63	1	004340401
1/4x19	9,0	63	1	004340402
3/8x19	9,0	70	1	004340403
1/2x14	12,0	80	1	004340404
5/8x14	14,0	90	1	004340405
3/4x14	16,0	100	1	004340406
7/8x14	18,0	100	1	004340407
1"x11	20,0	110	1	004340408

435

adjustable tap wrenches, steel body

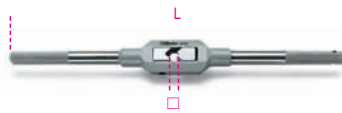

DIN 1814

	□ mm	L mm		
435/0	2÷4,9	140	3	004350007
435/1	2,1÷5,5	180	2	004350009
435/1,5	2,4÷7,3	180	2	004350011
435/2	2÷8	260	2	004350013
435/3	4,9÷14	380	1	004350020
435/4	5,5÷16	490	1	004350027
x M9÷M27				
435/5	8÷18	620	1	004350032
x M13÷M32				

435G

adjustable tap wrenches, light alloy body

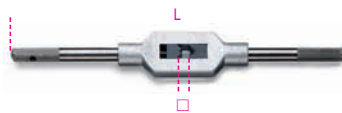

DIN 1814

	□ mm	L mm		
435G/0	2÷5	130	5	004350108
x M1÷M8				
435G/1	2÷6,3	190	5	004350110
x M1÷M10				
435G/1,5	2,1÷8	217	5	004350112
x M1÷M12				
435G/2	3÷9	280	5	004350114
x M4÷M12				
435G/3	4,9÷12	380	2	004350121
x M5÷M20				
435G/4	5,5÷16	500	2	004350127
x M11÷M27				
435G/5	7÷18	700	1	004350132
x M13÷M32				
435G/6	11÷24	800	1	004350142
x M18÷M42				

436

reversible ratcheting tap wrenches

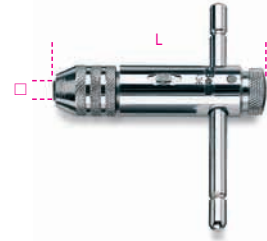

	□ mm	L mm		
436/1	2÷5	85	5	004360002
x M3÷M8				
436/2	4,6÷8	110	5	004360004
x M5÷M12				

436L

reversible ratcheting tap wrenches, long series

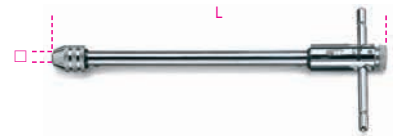

	□ mm	L mm		
436L/1	2÷5	245	2	004360012
x M3÷M8				
436L/2	4,6÷8	295	2	004360014
x M5÷M12				

436R

spare clamps for items 436 and 436L

436R/1	1	004360022
436R/2	1	004360024

437U/09

assortment for repairing damaged threads M5-M6-M8-M10-M12



437U/09	1	004370550
M 5x0,8		
M 6x1,0		
M 8x1,25		
M 10x1,5		
M 12x1,75		

437U/E-M...

stainless steel helicoids



M5	1	004370555
M6	1	004370556
M8	1	004370558
M10	1	004370560
M12	1	004370562

440

round dies, **coarse pitch**,
metric thread made from chrome-steel



UNI EN 22568

M		
2x0,4	5	004400002
3x0,5	5	004400003
4x0,7	5	004400004
5x0,8	5	004400005
6x1	5	004400006
7x1	5	004400007
8x1,25	5	004400008
9x1,25	5	004400009
10x1,5	5	004400010
12x1,75	5	004400012

440A

round dies, **coarse pitch**,
metric thread made from chrome-steel



UNI EN 22568

M		
10x1,5	3	004400110
11x1,5	3	004400111
12x1,75	3	004400112
14x2	3	004400114
16x2	3	004400116
18x2,5	3	004400118
20x2,5	3	004400120

440B

round dies, **coarse pitch**,
metric thread made from chrome-steel



UNI EN 22568

M		
18x2,5	3	004400122
20x2,5	3	004400124
22x2,5	3	004400126
24x3	3	004400128

440ASW

round dies, **Whitworth** thread
made from chrome-steel

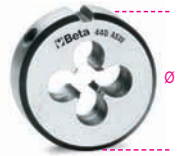

BSW	Ø mm	
1/8x40	25,4	5 004400201
5/32x32	25,4	5 004400202
3/16x24	25,4	5 004400203
1/4x20	25,4	5 004400204
5/16x18	25,4	5 004400205
3/8x16	38,1	3 004400206
7/16x14	38,1	3 004400207
1/2x12	38,1	3 004400208
9/16x12	38,1	3 004400209
5/8x11	50,8	3 004400210
3/4x10	50,8	3 004400211
7/8x9	50,8	3 004400212
1"x8	50,8	3 004400213

440ASC

round dies, **coarse pitch**,
UNC thread made from chrome-steel



UNC	Ø mm	
1/4x20	25,4	5 004400221
5/16x18	25,4	5 004400222
3/8x16	38,1	3 004400223
7/16x14	38,1	3 004400224
1/2x13	38,1	3 004400225
9/16x12	38,1	3 004400226
5/8x11	50,8	3 004400227
3/4x10	50,8	3 004400228
7/8x9	50,8	3 004400229
1"x8	50,8	3 004400230

440ASF

round dies, **fine pitch**,
UNF thread made from chrome-steel



ANSI B1.1

UNF	Ø mm	
1/4x28	25,4	5 004400241
5/16x24	25,4	5 004400242
3/8x24	38,1	3 004400243
7/16x20	38,1	3 004400244
1/2x20	38,1	3 004400245
9/16x18	38,1	3 004400246
5/8x18	50,8	3 004400247
3/4x16	50,8	3 004400248
7/8x14	50,8	3 004400249
1"x12	50,8	3 004400250

440ASG

round dies, cylindrical **GAS** (BSP) thread
made from chrome-steel



UNI 338 EN 22568

GAS	Ø mm	
1/8x28	38,1	3 004400255
1/4x19	38,1	3 004400256
3/8x19	38,1	3 004400257
1/2x14	50,8	3 004400259
3/4x14	50,8	3 004400260
1"x11	63,5	3 004400261

441

round dies, **fine pitch**, metric thread
made from chrome-steel



DIN 223 EN 22568

M		
6x0,75	5	004410004
7x0,75	5	004410005
8x0,75	5	004410006
8x1	5	004410007
9x0,75	5	004410008
9x1	5	004410009

441A

round dies, **fine pitch**, metric thread
made from chrome-steel



UNI EN 22568

M	ØxS mm	1	2
10x0,75	38x14	3	004410100
10x1	45x18	3	004410101
10x1,25	45x18	3	004410102
11x0,75	45x18	3	004410103
11x1	45x18	3	004410104
11x1,25	45x18	3	004410105
12x0,75	55x22	3	004410106
12x1	55x22	3	004410107
12x1,25	55x22	3	004410108
12x1,5	55x22	3	004410109
14x1	55x22	3	004410110
14x1,25	55x22	3	004410111
14x1,5	55x22	3	004410112
16x1	55x22	3	004410113
16x1,5	55x22	3	004410114
18x1,5	55x22	3	004410115

441B

round dies, **fine pitch**, metric thread
made from chrome-steel



UNI EN 22568

M	ØxS mm	1	2
18x1,5	30x11	3	004410117
18x2	38x10	3	004410118
20x1,5	45x14	3	004410119
22x1,5	45x14	3	004410120
24x1,5	45x14	3	004410121
24x2	45x14	3	004410122

442

round dies, **coarse pitch**, metric thread HSS



UNI EN 22568

M	ØxS mm	1	2
3x0,5	20x5	3	004420003
4x0,7	20x5	3	004420004
5x0,8	20x7	3	004420005
6x1	20x7	3	004420006
7x1	25x9	3	004420007
8x1,25	25x9	3	004420008
10x1,5	30x11	3	004420010
12x1,75	38x14	3	004420012

M	ØxS mm	1	2
14x2	38x14	1	004420014
16x2	45x18	1	004420016
18x2,5	45x18	1	004420018
20x2,5	45x18	1	004420020
22x2,5	55x22	1	004420022
24x3	55x22	1	004420024

442ASG

round dies, cylindrical **GAS** (BSP) thread
HSS



DIN 5158 ISO 4231 EN 22568

GAS	ØxS mm	1	2
1/8x28	30x11	1	004420255
1/4x19	38x10	1	004420256
3/8x19	45x14	1	004420257
1/2x14	45x14	1	004420258
5/8x14	55x16	1	004420259
3/4x14	55x16	1	004420260
7/8x14	65x18	1	004420261
1"x11	65x18	1	004420262

443

round dies, **fine pitch**, metric thread HSS



ISO 2568 EN 22568

M	ØxS mm	1	2
6x0,75	20x7	1	004430107
8x0,75	25x9	1	004430110
8x1	25x9	1	004430111
10x0,75	30x11	1	004430113
10x1	30x11	1	004430114
10x1,25	30x11	1	004430115
12x1	38x10	1	004430116
12x1,25	38x10	1	004430117
12x1,5	38x10	1	004430118
13x1,5	38x10	1	004430119
14x1	38x10	1	004430120
14x1,25	38x10	1	004430121
14x1,5	38x10	1	004430122
15x1,5	38x10	1	004430123
16x1	45x14	1	004430124
16x1,5	45x14	1	004430125
18x1,5	45x14	1	004430127
20x1,25	45x14	1	004430129
20x1,5	45x14	1	004430130
20x2	45x14	1	004430131
22x1,5	55x16	1	004430132
24x1	55x16	1	004430133
24x1,5	55x16	1	004430135
24x2	55x16	1	004430136

444

die stocks, steel body



UNI EN 22568

	Ø mm	L mm	1	2
444	20x5	215	5	004440005
444/0	20x7	215	5	004440007
444/1	25,4	225	5	004440025
444/1A	25x9	225	5	004440027
444/1B	30x11	300	5	004440030
444/C	38x10	315	3	004440033
444/1C	38x14	315	3	004440035
444/2	38x14	360	3	004440038
444/1D	45x14	455	1	004440045
444/2D	45x18	455	1	004440046
444/3	50,8	555	1	004440050
444/4	55x16	555	1	004440055
444/5A	63,5	630	1	004440057

444G

die stocks, light alloy body



UNI EN 22568

	Ø mm	L mm	1	2
444G/A	16x5	160	5	004440103
444G	20x5	200	5	004440105
444G/0	20x7	200	5	004440107
444G/1	25,4	210	5	004440125
444G/1A	25x9	224	5	004440127
444G/1B	30x11	280	5	004440130
444G/C	38x10	315	3	004440133
444G/1C	38x14	315	3	004440135
444G/2	38,1	320	3	004440138
444G/1D	45x14	450	1	004440145
444G/2D	45x18	450	1	004440146
444G/3	50,8	500	1	004440150
444G/4	55x16	560	1	004440155
444G/5A	63,5	620	1	004440163
444G/6	65x18	630	1	004440165

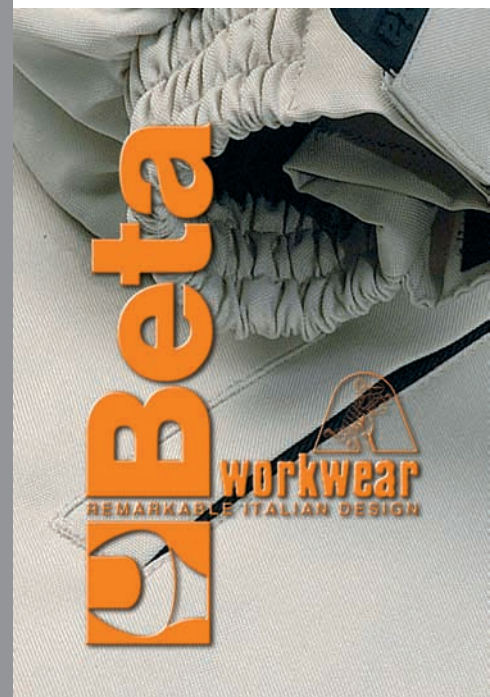

446/C30

assortment of chrome-steel taps and dies, metric thread, and accessories in wooden case



446/C30 1 004460055

325x220x35 mm - 1200 g

430 M mm	440 M mm	435/1,5	444/1
3x0,5	3x0,5		
4x0,7	4x0,7		
5x0,8	5x0,8		
6x1	6x1		
8x1,25	8x1,25		
10x1,5	10x1,5		
12x1,75	12x1,75		

446/C48

assortment of chrome-steel taps and dies, metric thread, and accessories in wooden case



446/C48 1 004460057

580x300x50 mm - 5000 g

430 M mm	440 M mm	440A M mm	435/1	444/1
3x0,5	3x0,5	10x1,5		
4x0,7	4x0,7	12x1,75		
5x0,8	5x0,8	14x2		
6x1	6x1	16x2		
8x1,25	8x1,25	18x2,5		
10x1,5		20x2,5		
12x1,75				
14x2				
16x2				
18x2,5				
20x2,5				

446/C110

assortment of chrome-steel taps and dies, metric thread, and accessories for car repair jobs in wooden case



446/C110 1 004460060

500x337x60 mm - 8100 g

430 M mm	433 M mm	440/440A M mm	441/441A M mm
2x0,4	6x0,75	2x0,4	6x0,75
3x0,5	7x0,75	3x0,5	7x0,75
4x0,7	8x0,75	4x0,7	8x0,75
5x0,8	8x1	5x0,8	8x1
6x1	9x0,75	6x1	9x0,75
7x1	9x1	7x1	9x1
8x1,25	10x0,75	8x1,25	10x0,75
9x1,25	10x1	9x1,25	10x1
10x1,5	10x1,25	10x1,5	10x1,25
11x1,5	11x0,75	11x1,5	11x0,75
12x1,75	11x1	12x1,75	11x1
14x2	11x1,25	14x2	11x1,25
16x2	12x0,75	16x2	12x0,75
	12x1		12x1
	12x1,25		12x1,25
	12x1,5		12x1,5
	14x1		14x1
	14x1,25		14x1,25
	14x1,5		14x1,5
	16x1		16x1
	16x1,5		16x1,5
	18x1,5		18x1,5

435/0	444/1	436/1
435/3	444/2	

446ASF/C29

assortment of chrome-steel taps and dies, UNF thread, and accessories in wooden case



446ASF/C29 1 004460070

660x410x50 mm - 6000 g

433ASF	440ASF	435/1,5	444/1
1/4	1/4		
5/16	5/16		
3/8	3/8		
7/16	7/16		
1/2	1/2		
9/16	9/16		
5/8	5/8		
3/4	3/4		

446ASW/C36

assortment of chrome-steel taps and dies, Whitworth thread, and accessories in wooden case



446ASW/C36 1 004460075

525x310x50 mm - 3400 g

430ASW	440ASW	435/1,5	444/1
1/8	1/8		
5/32	5/32		
3/16	3/16		
1/4	1/4		
5/16	5/16		
3/8	3/8		
7/16	7/16		
1/2	1/2		

446ASC/C37

assortment of chrome-steel taps and dies, **UNC** thread, and accessories in wooden case



446ASC/C37 1 004460080

660x410x50 mm - 6700 g

430ASC	440ASC		
1/4	1/4	435/1,5	444/1
5/16	5/16	435/3	444/2
3/8	3/8		444/3
7/16	7/16		
1/2	1/2		
9/16	9/16		
5/8	5/8		
3/4	3/4		

446ASG/C23

assortment of chrome-steel taps and dies, cylindrical **GAS** thread, and accessories in wooden case



446ASG/C23 1 004460085

700x430x70 mm - 9800 g

433ASG	440ASG		
1/8	1/8	435/3	444/2
1/4	1/4	435/5	444/3
3/8	3/8		444/5A
1/2	1/2		
3/4	3/4		
1"	1"		

447/C37

assortment of HSS taps and dies, metric thread, and accessories in metal case



447/C37 1 004470055

380x185x35 mm - 3960 g

431 M mm	442 M mm		
3x0,5	3x0,5	435/0	444
4x0,7	4x0,7	435/2	444/0
5x0,8	5x0,8		444/1A
6x1	6x1		444/1B
8x1,25	8x1,25		444/1C
10x1,5	10x1,5		
12x1,75	12x1,75		

436/1	0,5x3x75
-------	----------

447/C53

assortment of HSS taps and dies, metric thread, and accessories in metal case



447/C53 1 004470060

500x235x50 mm - 9000 g

431 M mm	442 M mm			
3x0,5	3x0,5	435/1,5	444	436/1
4x0,7	4x0,7	435/3	444/0	
5x0,8	5x0,8		444/1A	
6x1	6x1		444/1B	
8x1,25	8x1,25		444/1C	
10x1,5	10x1,5		444/2D	
12x1,75	12x1,75			
14x2	14x2			
16x2	16x2			
18x2,5	18x2,5			
20x2,5	20x2,5			

447/C70

assortment of HSS taps and dies, metric thread, and accessories for car repair jobs industrial maintenance in wooden case



447/C70 1 004470065

510x340x70 mm - 7500 g

431 M mm	434 M mm	442 M mm	443 M mm
3x0,5	8x1	3x0,5	8x1
4x0,7	10x1,25	4x0,7	10x1,25
5x0,8	12x1,25	5x0,8	12x1,25
6x1	12x1,5	6x1	12x1,5
7x1	14x1,25	7x1	14x1,25
8x1,25	14x1,5	8x1,25	14x1,5
10x1,5	16x1,5	10x1,5	16x1,5
12x1,75		12x1,75	
14x2		14x2	
16x2		16x2	

435/0	444	436/1
435/3	444/0	
	444/1A	
	444/1B	
	444/1C	
	444/1D	

450

holesaws HSS, Bimetal

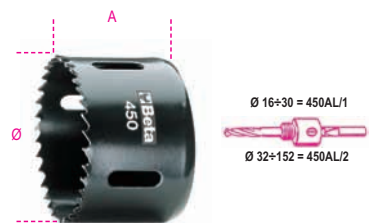

Ø mm	Ø "	A mm	
16	(5/8)	57	1 004500016
17	(11/16)	57	1 004500017
19	(3/4)	51	1 004500019
20	-	51	1 004500020
21	(13/16)	51	1 004500021
22	(7/8)	51	1 004500022
24	(15/16)	51	1 004500024
25	(1")	51	1 004500025
27	(1"1/16)	51	1 004500027
29	(1"1/8)	51	1 004500029
30	(1"3/16)	51	1 004500030
32	(1"1/4)	51	1 004500032
33	(1"5/16)	51	1 004500033
35	(1"3/8)	51	1 004500035

Ø mm	Ø	A mm		
37	(1"7/16)	51	1	004500037
38	(1"1/2)	44	1	004500038
40	(1"9/16)	44	1	004500040
41	(1"5/8)	44	1	004500041
43	(1"11/16)	44	1	004500043
44	(1"3/4)	44	1	004500044
46	(1"13/16)	44	1	004500046
48	(1"7/8)	44	1	004500048
51	(2")	44	1	004500051
52	(2"1/16)	44	1	004500052
54	(2"1/8)	44	1	004500054
57	(2"1/4)	44	1	004500057
59	(2"5/16)	44	1	004500059
60	(2"3/8)	44	1	004500060
64	(2"1/2)	44	1	004500064
65	(2"9/16)	44	1	004500065
67	(2"5/8)	44	1	004500067
68	-	44	1	004500068
70	(2"3/4)	44	1	004500070
73	(2"7/8)	44	1	004500073
76	(3")	44	1	004500076
79	(3"1/8)	44	1	004500079
83	(3"1/4)	44	1	004500083
86	(3"3/8)	44	1	004500086
89	(3"1/2)	44	1	004500089
92	(3"5/8)	44	1	004500092
95	(3"3/4)	44	1	004500095
98	(3"7/8)	44	1	004500098
102	(4")	44	1	004500102
105	(4"1/8)	44	1	004500105
108	(4"1/4)	44	1	004500108
111	(4"3/8)	44	1	004500111
114	(4"1/2)	44	1	004500114
121	(4"3/4)	44	1	004500121
127	(5")	44	1	004500127
140	(5"1/2)	44	1	004500140
152	(6")	44	1	004500152

450AL

arbors for holesaws

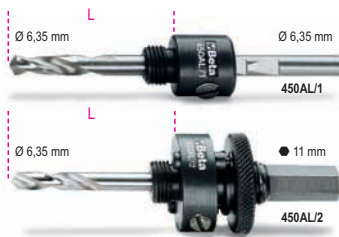

	Ø mm	L mm		
450AL/1	16÷30	54	1	004500210
450AL/2	32÷152	70	1	004500215

450AD

adaptors for arbors item 450AL/1



	Ø mm		
450AD	32÷51	1	004500230

450PA/1

pilot drills for arbors item 450AL/1, HSS

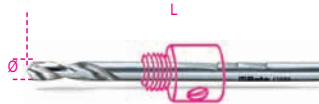

	ØxL mm		
450PA/1	6,35x105	1	004500252

450PA/2

pilot drills for arbors item 450AL/2, HSS

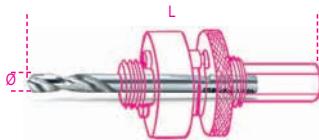

	ØxL mm		
450PA/2	6,35x80	1	004500253

450PR

extension for holesaws



	L mm		
450PR	305	1	004500255

450/C9

assortment of holesaws and accessories for electricians



450/C9		1	004500305

450 Ø 22 - 29 - 35 - 44 - 51 - 64 mm

450AL /1 - /2

450AD

220x160x60 mm - 1120 g

450/C13

assortment of holesaws and accessories for installers



450/C13		1	004500310

450 Ø 19 - 22 - 29 - 35 - 38
44 - 51 - 57 - 64 mm

450AL /1 - /2

450PA/1

450AD

215x180x65 mm - 1435 g

450/C21

assortment of holesaws and accessories for industrial use



450/C21		1	004500315

450 Ø 19 - 22 - 29 - 35 - 38
44 - 51 - 57 - 64 - 76
83 - 92 - 95 - 105 - 114 mm

450AL /1 - /2

450PA /1 - /2

450PR

450AD

420x280x60 mm - 5200 g

Beta
SHOP
in Shop



451

hole cutters HSS, entirely ground

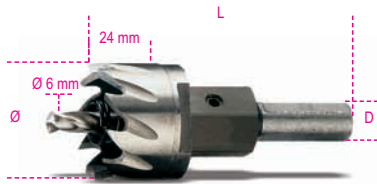

Ø mm	L mm	D		
12	85	8	1	004510012
13	85	8	1	004510013
14	85	8	1	004510014
15	85	10	1	004510015
16	85	10	1	004510016
17	85	10	1	004510017
18	85	10	1	004510018
19	85	10	1	004510019
20	85	10	1	004510020
21	85	10	1	004510021
22	85	10	1	004510022
23	85	10	1	004510023
24	85	10	1	004510024
25	85	10	1	004510025
26	90	10	1	004510026
27	90	10	1	004510027
28	90	10	1	004510028
29	90	10	1	004510029
30	90	10	1	004510030
31	90	10	1	004510031
32	90	10	1	004510032
33	90	10	1	004510033
34	90	10	1	004510034
35	90	10	1	004510035
36	85	10	1	004510036
37	85	10	1	004510037
38	85	10	1	004510038
39	85	10	1	004510039
40	85	10	1	004510040
41	85	10	1	004510041
42	85	10	1	004510042
43	85	10	1	004510043
44	85	10	1	004510044
45	85	10	1	004510045
46	85	10	1	004510046
47	85	10	1	004510047
48	85	10	1	004510048
49	85	10	1	004510049
50	85	10	1	004510050

451GA

arbors for hole cutters item 451



M	Ø mm	L mm	D mm		
10x1,25	12÷14	57	8	1	004510101
12x1,25	15÷34	57	10	1	004510102
14x1,5	35÷50	57	10	1	004510105

451PA

pilot drill for hole cutters item 451
HSS



Ø mm	L mm		
6	53	1	004510103

451PR

extension for hole cutters item 451



M	Ø mm	L mm		
12x1,25	15÷34	400	1	004510104
14x1,5	35÷50	400	1	004510108

452

hole cutters with hard metal insets



Ø mm	Ø1 mm	L mm		
15	10	90	1	004520015
16	10	90	1	004520016
17	10	90	1	004520017
18	10	90	1	004520018
19	10	90	1	004520019
20	10	90	1	004520020
21	10	95	1	004520021
22	10	95	1	004520022
23	10	95	1	004520023
24	10	95	1	004520024
25	10	95	1	004520025
26	10	95	1	004520026
27	10	95	1	004520027
28	10	95	1	004520028
29	10	95	1	004520029
30	10	95	1	004520030
31	10	95	1	004520031
32	10	95	1	004520032
33	10	95	1	004520033
34	10	95	1	004520034
35	10	95	1	004520035
36	10	95	1	004520036
37	10	95	1	004520037
38	10	95	1	004520038
39	13	95	1	004520039
40	13	95	1	004520040
41	13	95	1	004520041
42	13	95	1	004520042
43	13	95	1	004520043
44	13	95	1	004520044
45	13	95	1	004520045
46	13	95	1	004520046
47	13	95	1	004520047
48	13	95	1	004520048
49	13	95	1	004520049
50	13	90	1	004520050
55	13	90	1	004520055
60	13	90	1	004520060
65	13	90	1	004520065
70	13	95	1	004520070
75	13	95	1	004520075
80	13	95	1	004520080
85	13	95	1	004520085
90	13	95	1	004520090

452GA

arbors for hole cutters item 452



	Ø mm		
452GA/1	15÷21	1	004520125
452GA/2	22÷38	1	004520126
452GA/3	39÷100	1	004520127

560/C2

torque multiplier, ratio 5:1,
and accessories in plastic case

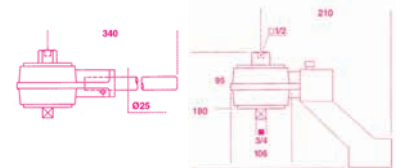

Nm	Kgfm	lbf.ft	□	■	kg
1300	130	960	1/2	3/4	3,8

560/C2	1	005600020	
560/2	1	005600002	
560/18	1	005600018	
560/19	1	005600019	
560/22	1	005600022	



560/C4+

torque multiplier
ratio 5:1
with reaction foot



560/18

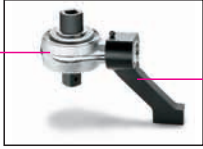

560/4

560/22

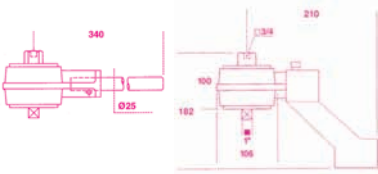

Nm	Kgfm	lbf.ft	□	■	kg
2700	270	2000	3/4"	1"	5

560/C4+	1	005600042
560/4	1	005600004
560/18	1	005600018
560/22	1	005600022

560/C6

torque multipliers for right-hand and left-hand
tightening in plastic case
ratio: 6.5:1



Nm	kgfm	lbf.ft	□	■	kg
1500	150	1106	1/2"	3/4"	6

560/C6	1	005600160
--------	---	-----------

560/C12

torque multipliers for right-hand and left-hand
tightening in plastic case
ratio: 12:1



Nm	kgfm	lbf.ft	□	■	kg
2500	250	1844	1/2"	1"	7

560/C12	1	005600210
---------	---	-----------

561

torque multiplier, ratio 5:1



Nm	Kgfm	lbf.ft	□	■	kg
1000	100	740	1/2"	3/4"	4,6

561	1	005610001
-----	---	-----------

562/1 - 562/2

torque multipliers, ratio 5:1

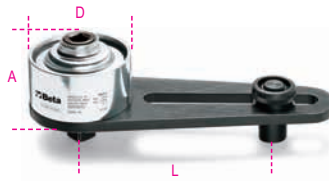

Nm	Kgfm	lbf.ft	□	■	D mm	A mm	L min mm	L max mm	kg
1700	170	1250	3/4"	1"	108	95	85	220	5,3

562/1	1	005620001
-------	---	-----------

Nm	Kgfm	lbf.ft	□	■	D mm	A mm	L min mm	L max mm	kg
3400	340	2500	3/4"	1"	119	115	85	265	7,0

562/2	1	005620002
-------	---	-----------

564/3R - 564/4R

torque multipliers, ratio 25:1,
with anti-wind up system



Nm	Kgfm	lbf.ft	□	■	D mm	A mm	L mm	kg
3000	300	2200	1/2"	1"	108	188	155	9,2

564/3R	1	005640003
--------	---	-----------

Nm	Kgfm	lbf.ft	□	■	D mm	A mm	L mm	kg
6000	600	4500	1/2"	1 1/2"	119	235	200	15,5

564/4R	1	005640004
--------	---	-----------

565/1R - 565/2R - 565/3R

torque multipliers, ratio 25:1
with anti-wind up system



Nm	Kgfm	lbf.ft	□	■	D mm	A mm	L min mm	L max mm	kg
1700	170	1250	1/2"	1"	108	125	80	215	7,7

565/1R	1	005650011
--------	---	-----------

Nm	Kgfm	lbf.ft	□	■	D mm	A mm	L min mm	L max mm	kg
3400	340	2500	1/2"	1"	119	145	85	265	10,1

565/2R	1	005650012
--------	---	-----------

Nm	Kgfm	lbf.ft	□	■	D mm	A mm	L min mm	L max mm	kg
3400	340	2500	1/2"	1 1/2"	119	145	85	265	10,7

565/3R	1	005650013
--------	---	-----------

565/4R

torque multiplier, ratio 25:1
with anti-wind up system

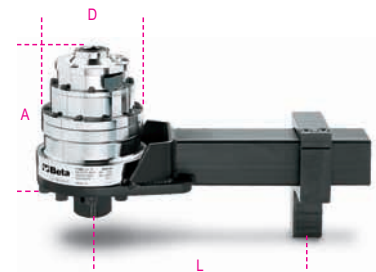

Nm	Kgfm	lbf.ft	□	■	D mm	A mm	L min mm	L max mm	kg
6000	600	4500	1/2"	1 1/2"	144	180	125	335	17

565/4R	1	005650014
--------	---	-----------

565/5R

torque multiplier, ratio 25:1
with anti-wind up system

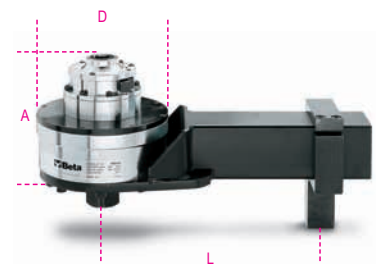

Nm	Kgfm	lbf.ft	□	■	D mm	A mm	L min mm	L max mm	kg
9500	950	7000	3/4"	1 1/2"	184	180	155	355	25

565/5R	1	005650015
--------	---	-----------

567/4R

torque multiplier, ratio 125:1
with anti-wind up system

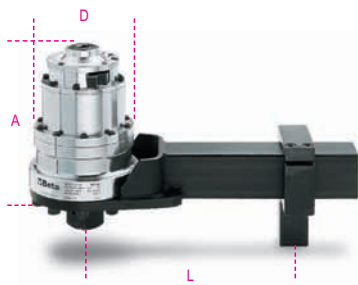

Nm	Kgfm	lbf.ft	□	■	D mm	A mm	L min mm	L max mm	kg
6000	600	4500	1/2	1 1/2	144	210	125	335	19

567/4R 1 005670014

567/5R

torque multiplier, ratio 125:1
with anti-wind up system

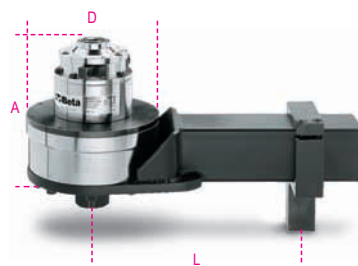

Nm	Kgfm	lbf.ft	□	■	D mm	A mm	L min mm	L max mm	kg
9500	950	7000	1/2	1 1/2	184	210	155	350	27

567/5R 1 005670015

581

slip-torque screwdriver, ungraduated
for right-hand and left-hand tightening
torque accuracy: ±6%
(to be used with items 588 - 682)



UNI EN 26789
ISO 6789

Nm	Kgfm	lbf.in	□	■	D mm	A mm	L min mm	L max mm	kg
1,2÷6	120÷600	1/4"			275				

581 1 005810001

583

slip-torque screwdriver, ungraduated
for right-hand and left-hand tightening
torque accuracy: ±6%



UNI EN 26789
ISO 6789

Nm	Kgfm	lbf.in	□	■	D mm	A mm	L min mm	L max mm	kg
0,3÷1,5	30÷150	1/4"			200				

583/1,5 1 005830015

Nm	Kgfm	lbf.in	□	■	D mm	A mm	L min mm	L max mm	kg
0,6÷3	60÷300	1/4"			230				

583/3 1 005830030

Nm	Kgfm	lbf.in	□	■	D mm	A mm	L min mm	L max mm	kg
1,2÷6	120÷600	1/4"			350				

583/6 1 005830060

588

electronic digital torque meter

For testing and setting torque screwdrivers 581-583



Nm	lbf.in	□	■	kg
1÷10	10÷90	1/4"		2

588 1 005880001

590 + 592/4

direct reading torque wrenches
for right-hand and left-hand tightening
torque accuracy: ±4%

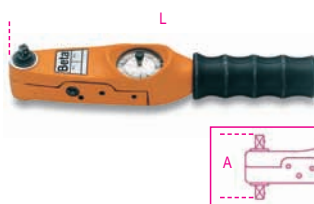

UNI EN 26789
ISO 6789

Nm	Kgfm	lbf.in	■	A mm	L mm	kg
0,3÷4	0,03÷0,4	3÷35	1/4	60	253	0,52

590 1 005900001

Nm	Kgfm	lbf.in	■	A mm	L mm	kg
0,5÷13,5	0,05÷1,35	4÷120	1/4	60	253	0,52

590/1 1 005900003

Nm	Kgfm	lbf.in	■	A mm	L mm	kg
1÷27	0,1÷2,7	10÷240	3/8	70	253	0,52

592/3 1 005920005

Nm	Kgfm	lbf.in	■	A mm	L mm	kg
3÷40	0,3÷4	20÷360	3/8	70	253	0,52

592/4 1 005920007

Beta

594/8 - 594/21

direct reading torque wrenches
for right-hand and left-hand tightening
torque accuracy: ±4%



UNI EN 26789
ISO 6789

Nm	Kgfm	lbf.ft	■	A mm	L mm	kg
6÷80	0,6÷8	5÷60	1/2	85	455	1,35

594/8 1 005940011

Nm	Kgfm	lbf.ft	■	A mm	L mm	kg
20÷215	2÷21,5	15÷160	1/2	85	530	1,40

594/21 1 005940015

Beta
Collection

596/80SL - 598/200SL

direct reading torque wrenches
for right-hand and left-hand tightening
torque accuracy: $\pm 4\%$

A signal light and an intermittent sound mean the pre-set torque load is achieved.



UNI EN 26789
ISO 6789

Nm	Kgfm	lbf.ft	■	A mm	L mm	kg
40÷800	4÷80	20÷600	3/4	115	1025	4,85

596/80SL 1 005960020

Nm	Kgfm	lbf.ft	■	A mm	L mm	kg
200÷2000	20÷200	150÷1500	1"	135	1930	16,70

598/200SL 1 005980022

599DGT

electronic torque wrench
with reversible ratchet, right-hand
and left-hand tightening, torque accuracy:
+/- 2% right-hand,
+/- 3% left-hand

buzzer and LED indicator for pre-settable target torque
• Power supply: 2 1.5V batteries (included)

CE



UNI EN 26789
ISO 6789

Nm	Kgfm	lbf.ft	■	D mm	A mm	L mm	kg
12÷60	1,2÷6	8÷44	3/8	30	33	413	0,8

599DGT/6 1 005990003

Nm	Kgfm	lbf.ft	■	D mm	A mm	L mm	kg
20÷100	2÷20	15÷80	1/2	30	37	413	1

599DGT/10X 1 005990010

Nm	Kgfm	lbf.ft	■	D mm	A mm	L mm	kg
40÷200	4÷20	30÷150	1/2	40	43	520	2

599DGT/20 1 005990020

Nm	Kgfm	lbf.ft	■	D mm	A mm	L mm	kg
68÷340	6,8÷34	58÷280	1/2	40	43	539	2,35

599DGT/30 1 005990030

600/1 - 600/2

torque angle indicators

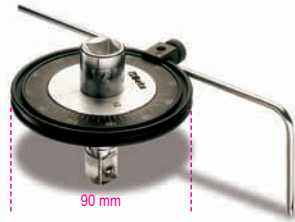

600/1	□	■	1	006000001
1/2	1/2			
600/2	3/4	3/4		1 006000002

601

electronic torque angle indicator

LED indicators and buzzer for pre-settable angle

CE



601 1/2	□	■	1	006010001
1/2"	1/2"			
601 3/4 <td>3/4"</td> <td>3/4"</td> <td></td> <td>1 006010002</td>	3/4"	3/4"		1 006010002

603/5 - 603/10

calibrated slipping torque wrenches
for right-hand tightening
torque accuracy: $\pm 6\%$

1 1/4"



ISO 6789

Nm	Kgfm	lbf.in	■	A mm	L mm	g
1÷5	0,1÷0,5	10÷45	1/4	35	195	235

603/5 1 006030005

Nm	Kgfm	lbf.in	■	A mm	L mm	g
2÷10	0,2÷1,0	18÷90	1/4	35	195	235

603/10 1 006030010

604/5

click-type torque wrench
torque accuracy: $\pm 6\%$



ISO 6789

Nm	Kgfm	lbf.in	■	L mm	g
1÷5	0,1÷0,5	10÷45	1/4"	170	120

604/5 1 006040001

606/2 - 606/2X

click-type torque wrenches
with reversible ratchets
for right-hand tightening
torque accuracy: $\pm 4\%$

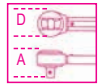

UNI EN 26789
ISO 6789

Nm	Kgfm	lbf.in	■	D mm	A mm	L mm	g
4÷20	0,4÷2	40÷180	1/4	28	25	220	400

606/2 1 006060102

Nm	Kgfm	lbf.in	■	D mm	A mm	L mm	g
4÷20	0,4÷2	40÷180	3/8	28	31	220	400

606/2X 1 006060103

606/6 + 606/30

click-type torque wrenches
with reversible ratchets
for right-hand tightening
torque accuracy: $\pm 4\%$

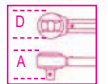

UNI EN 26789
ISO 6789

Nm	Kgfm	lbf.ft	■	D mm	A mm	L mm	g
8÷60	0,8÷6	6÷44	3/8	30	33	305	595

606/6 1 006060105

Nm	Kgfm	lbf.ft	■	D mm	A mm	L mm	g
20÷100	2÷10	15÷80	3/8	30	33	345	660

606/10 1 006060110

Nm	Kgfm	lbf.ft	■	D mm	A mm	L mm	g
20÷100	2÷10	15÷80	1/2	30	37	345	680

606/10X 1 006060111

Nm	Kgfm	lbf.ft	■	D mm	A mm	L mm	g
40÷200	4÷20	30÷150	1/2	40	43	440	920

606/20 1 006060120

Nm	Kgfm	lbf.ft	■	D mm	A mm	L mm	g
60÷330	6÷33	40÷250	1/2	40	43	560	1180

606/30 1 006060130

608/2

click-type torque bar
for right-hand and left-hand tightening
torque accuracy: ±4%



UNI EN 26789
ISO 6789

Nm	Kgfm	lbf.in	∅ mm	L mm	g
4÷20	0,4÷2	40÷180	16	208	330

608/2 1 006080102

612 + 614

reversible ratchets for torque bars



Items 612 and 612X should not be used
with tightening torques exceeding 100 Nm

■	L mm	g
612	3/8 66	3 006120000
612X	1/2 66	3 006120010
614	1/2 71	3 006140000
614X	3/4 71	3 006140004

614/50

push-through ratchet for torque bars



■	L mm	g
614/50	1/2 71	3 006140002

Spare parts
rotating mechanism of ratchets,
see table after item 929/C8

616 - 617 - 619

fixed heads for torque bars



■	L mm	g
616	1/4 61	3 006160000
617	3/8 61	3 006170000
619	1/2 63	3 006190000

642

open jaw wrenches for torque bars



∅ mm	L mm	g
10	57	2 006420010
12	58	2 006420012
13	58	2 006420013
14	59	2 006420014
17	60	2 006420017
19	61	2 006420019

652

ring wrenches for torque bars

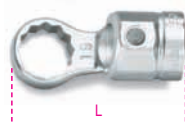

∅ mm	L mm	g
10	59	2 006520010
13	61	2 006520013
14	62	2 006520014
17	64	2 006520017
19	65	2 006520019



666

click-type torque wrenches
with reversible ratchets
for right-hand tightening
torque accuracy: ±4%



UNI EN 26789
ISO 6789

Nm	Kgfm	lbf.ft	■	D mm	A mm	L mm	g
8÷60	0,8÷6	6÷44	3/8	30	33	305	600

666/6 1 006660106

Nm	Kgfm	lbf.ft	■	D mm	A mm	L mm	g
20÷100	2÷10	15÷80	3/8	30	33	345	680

666/10 1 006660110

Nm	Kgfm	lbf.ft	■	D mm	A mm	L mm	g
20÷100	2÷10	15÷80	1/2	30	37	350	780

666/10X 1 006660111

Nm	Kgfm	lbf.ft	■	D mm	A mm	L mm	g
40÷200	4÷20	30÷150	1/2	40	43	440	995

666/20 1 006660120

Nm	Kgfm	lbf.ft	■	D mm	A mm	L mm	g
60÷330	6÷33	40÷250	1/2	40	43	560	1260

666/30 1 006660130

667

click-type torque wrenches
with push-through ratchets
for right-hand and left-hand tightening
torque accuracy: ±4%



UNI EN 26789
ISO 6789

Nm	Kgfm	lbf.ft	■	D mm	A mm	L mm	g
40÷200	4÷20	30÷150	1/2	40	43	440	960

667/20 1 006670120

Nm	Kgfm	lbf.ft	■	D mm	A mm	L mm	g
60÷330	6÷33	40÷250	1/2	40	43	560	1260

667/30 1 006670130

Nm	Kgfm	lbf.ft	■	D mm	A mm	L mm	g
80÷400	8÷40	60÷320	3/4	50	50	690	2200

667/40 1 006670140

667/C3

assortment of one click-type torque wrench with push-through ratchet item 667/40 and three hexagon sockets



667/C3 3/4 1 006670240

667/40
928A 24-27-30 mm

**Spare parts
rotating mechanism of ratchets,
see table after item 929/C8**

668

click-type torque bars
for right-hand and left-hand tightening
torque accuracy: $\pm 4\%$



UNI EN 26789
ISO 6789

Nm	Kgfm	lbf.ft	Ø mm	L mm	g
8÷60	0,8÷6	6÷44	16	300	530

668/5 1 006680105

Nm	Kgfm	lbf.ft	Ø mm	L mm	g
20÷100	2÷10	15÷80	16	340	610

668/10 1 006680110

Nm	Kgfm	lbf.ft	Ø mm	L mm	g
40÷200	4÷20	30÷150	16	420	780

668/20 1 006680120

Nm	Kgfm	lbf.ft	Ø mm	L mm	g
60÷300	6÷30	40÷220	16	550	1100

668/30 1 006680130

668RG

click-type torque bar, ungraduated
for right-hand and left-hand tightening
torque accuracy: $\pm 4\%$
(to be used with items 680 - 682)



UNI EN 26789
ISO 6789

Nm	Kgfm	lbf.ft	Ø mm	L mm	g
8÷60	0,8÷6	6÷44	16	288	550

668RG/6 1 006680206

Nm	Kgfm	lbf.ft	Ø mm	L mm	g
10÷100	1÷10	8÷80	16	315	600

668RG/10 1 006680210

Nm	Kgfm	lbf.ft	Ø mm	L mm	g
20÷200	2÷20	15÷150	16	405	780

668RG/20 1 006680220

Nm	Kgfm	lbf.ft	Ø mm	L mm	g
30÷300	3÷30	22÷220	16	645	1130

668RG/30 1 006680230

671/C10

torque bar item 668/10 and accessories



671/C10 1 006710010

668/10	100 Nm
612	■ 3/8
617	■ 3/8
642	10-13-14-17-19 mm
652	10-13-14-17-19 mm
910A	□ 3/8-8-10-11-13-14-17-19 mm
910/21	125 mm
910/22	250 mm

400x180x45 mm - 4300 g

671/C20

torque bar item 668/20 and accessories

12"



671/C20 1 006710020

668/20	200 Nm
614	■ 1/2
619	■ 1/2
642	10-13-14-17-19 mm
652	10-13-14-17-19 mm
920A	□ 1/2-10-11-13-14-17-19-22 mm
920/20	75 mm
920/21	125 mm
920/22	255 mm

510x180x45 mm - 5500 g

671/C30

torque bar item 668/30 and accessories

12"



671/C30 1 006710030

668/30	300 Nm
614	■ 1/2
619	■ 1/2
642	13-14-17-19 mm
652	13-14-17-19 mm
920A	□ 1/2-13-14-17-19-22-24-27 mm
920/20	75 mm
920/21	125 mm
920/22	255 mm

620x180x45 mm - 5800 g

Beta
SHOP
in Shop

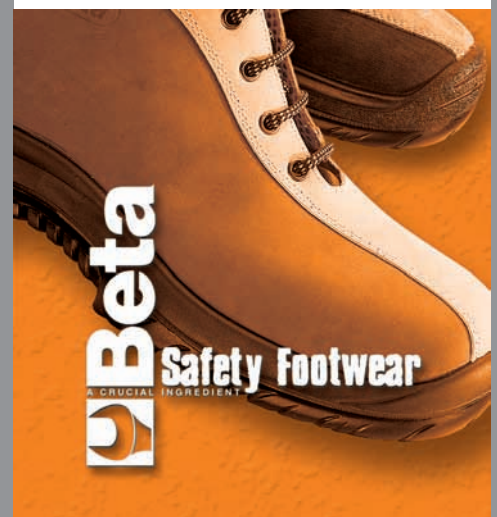

677

break-back torque wrenches with push-through ratchets for right-hand and left-hand tightening torque accuracy: $\pm 4\%$



UNI EN 26789
ISO 6789

Nm	Kgfm	lbf.ft	D mm	A mm	L mm	kg
100÷500	10÷50	70÷350	70	55	915	5,2

677/50 1 006770050

Nm	Kgfm	lbf.ft	D mm	A mm	L mm	kg
150÷700	15÷70	100÷500	70	55	1140	6,2

677/70 1 006770070

Nm	Kgfm	lbf.ft	D mm	A mm	L mm	kg
300÷1000	30÷100	200÷750	70	55	1470	7,5

677/100 1 006770100

677/C...

torque wrenches item 677 in case



677/C50 1 006770605

Nm 100÷500

677/C70 1 006770610

Nm 150÷700

677/C100 1 006770615

Nm 300÷1000

678

click-type torque wrenches with push-through ratchets for right-hand and left-hand tightening torque accuracy: $\pm 4\%$



UNI EN 26789
ISO 6789

Nm	Kgfm	lbf.ft	D mm	A mm	L mm	kg
110÷550	11÷55	80÷405	61	55	845	3,7

678/55 1 006780055

Nm	Kgfm	lbf.ft	D mm	A mm	L mm	kg
300÷1000	30÷100	220÷750	75	60	1250	6,0

678/100 1 006780100

Nm	Kgfm	lbf.ft	D mm	A mm	L mm	kg
500÷1500	50÷150	370÷1100	75	60	1570	6,7

678/150 1 006780150

678/C...

torque wrenches item 678 in case



678/C55 1 006780605

Nm 110÷550

678/C100 1 006780610

Nm 300÷1000

678/C150 1 006780615

Nm 500÷1500

678/CV...

empty cases for torque wrenches items 677 and 678



678/CV1 1 006780405

677/50-678/55

678/CV2 1 006780410

677/70-678/100

678/CV3 1 006780415

677/100-678/150

680/40

electronic digital torque meter Dynatester 680 for checking calibration to be used either clockwise or anticlockwise



680/40 16÷400 1 006800040

682

electronic digital torque meter with transducer Dynatester 682 to be used either clockwise or anticlockwise Remarkable reading accuracy Supplied with serial output RS 232 for printers



TECHNICAL FEATURES

Reading accuracy

$\pm 1\%$ of the read value

Available measuring units

Nm-dNm-cNm-Lbf.ft-Lbf.in-Oz.ft-in-Kgf.m-Kgf.cm-gf.cm

Supply range

90 to 264 V AC at 50/60 Hz

Dimensions

235x185x185 mm

Tolerance test according to norm ISO 6789

Acceptability range

for each torque wrench tested

Display

Menu available in 11 languages

Provided with all certificates required

Calibration certificate with UKAS traceability

	Nm	
682/60	1,2÷60	1 006820006
682/400	8÷400	1 006820040
682/1500	30÷1500	1 006820150

710

impact sockets, standard series

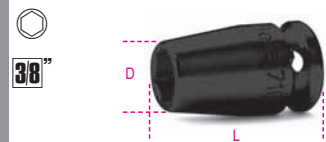

UNI/ISO 2725 DIN 3129

mm	D mm	L mm	
7	12,5	28	5 007100007
8	13,8	28	5 007100008
9	15,0	28	5 007100009
10	16,3	28	5 007100010
11	17,5	30	5 007100011
12	19,0	30	5 007100012
13	20,0	30	5 007100013
14	21,3	30	5 007100014
16	23,8	30	5 007100016
17	25,0	30	5 007100017
18	26,3	30	5 007100018
19	27,5	30	5 007100019
21	30,0	32	5 007100021
22	32,0	32	5 007100022

710/16

impact adaptor, 3/8" female and 1/2" male drives

3/8"



710/16	3/8	1/2	L mm		
			32	3	007100810

710/20

3/8" drive impact extension bar

3/8"



710/20	L mm		
	75	3	007100821

710/21

3/8" drive impact extension bar

3/8"



710/21	L mm		
	125	3	007100823

710/25

3/8" drive impact universal joint

3/8"



710/25	L mm		
	58	2	007100830

710/C10

10 impact sockets

3/8"



710/C10			
	7-8-10-11-12-13	1	007100910
	14-17-19-22 mm		

130x55x40 mm - 800 g

710/OR... - 710/SP...

rubber O-rings and locking pins for impact sockets

3/8"

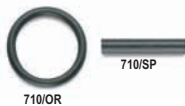

710/OR1			
	10	007100921	
710/OR2	10	007100922	
710/SP1	10	007100911	
710/SP2	10	007100912	

720

impact sockets, standard series

12"



UNI/ISO 2725 DIN 3129

mm	D mm	L mm		
10	17,0	38	5	007200010
11	18,5	38	5	007200011
12	20,0	38	5	007200012
13	21,0	38	5	007200013
14	22,5	38	5	007200014
15	23,0	38	5	007200015
16	25,0	38	5	007200016
17	26,0	38	5	007200017
18	27,5	38	5	007200018
19	28,5	38	5	007200019
21	31,0	38	5	007200021
22	32,5	38	5	007200022
23	34,0	38	5	007200023
24	35,0	38	5	007200024
27	38,5	45	3	007200027
30	42,0	50	3	007200030
32	44,0	50	3	007200032
36	50,0	50	3	007200036

720AS

impact sockets, standard series

12"



mm	D mm	L mm		
3/8	17,0	38	3	007200210
7/16	18,2	38	3	007200211
1/2	20,7	38	3	007200213
9/16	22,0	38	3	007200214
5/8	24,5	38	3	007200216
11/16	25,7	38	3	007200217
3/4	28,2	38	3	007200219
13/16	30,7	38	3	007200221
7/8	32,0	38	3	007200222
15/16	34,5	38	3	007200224
1	35,7	38	3	007200225
1.1/16	38,2	40	3	007200227
1.1/8	40,7	42	3	007200229
1.1/4	44,5	42	3	007200232

720L

impact sockets, long series

12"



UNI/ISO 2725

mm	D mm	D1 mm		
10	17,0	25	3	007200310
11	18,5	25	3	007200311
12	20,0	25	3	007200312
13	21,0	25	3	007200313
14	22,5	25	3	007200314
15	23,0	30	3	007200315
16	25,0	30	3	007200316
17	26,0	30	3	007200317
18	27,5	30	3	007200318
19	28,5	30	3	007200319
21	31,0	30	3	007200321
22	32,5	30	3	007200322
24	35,0	30	3	007200324
27	38,5	30	3	007200327
30	42,0	30	2	007200330
32	44,0	30	2	007200332
36	50,0	30	2	007200336

720L/S3

set of 3 impact sockets item 720L

12"



mm			
17-19-21	1	007200355	

720PL

impact sockets for wheel nuts, with polymeric material insets

12"



mm	D mm		
17	29,5	2	007200617
19	29,5	2	007200619
21	31,0	2	007200621
22	33,0	2	007200622
24	35,0	2	007200624



720PL/C5

impact sockets for wheel nuts, with polymeric material insets



720PL/C5
17-19-21-22-24 mm

1 007200650

240x165x50 mm - 1,8 kg

720LPL

impact sockets for wheel nuts, with polymeric material insets, long series



mm	D mm	
17	24,3	1 007200717
19	26,2	1 007200719
21	28,5	1 007200721

720LPL/C3

impact sockets for wheel nuts, long series, with polymeric material insets

supplied with 3 spare insets



720LPL/C3
17-19-21 mm

1 007200750

270x185x60 mm - 1 kg

720IP

spare polymeric material insets for impact sockets 720PL-LPL



720IP	mm	
720IP17	17	1 007200667
720IP19	19	1 007200669
720IP21	21	1 007200671
720IP22	22	1 007200672
720IP24	24	1 007200674

720FTX

impact sockets, for Torx® head screws



	D mm	L mm	
E10	14,0	38	3 007200410
E12	15,9	38	3 007200412
E14	17,7	38	3 007200414
E16	20,0	38	3 007200416
E18	22,0	38	3 007200418
E20	25,0	40	3 007200420



720FTX/SB6
E10-E12-E14
E16-E18-E20

1 007200450

720TX

impact socket drivers for Torx® head screws



	L mm	
T30	60	3 007200460
T40	60	3 007200470
T45	68	3 007200472
T50	68	3 007200474
T55	68	3 007200476
T60	68	3 007200478

720TX/C6

6 impact socket drivers for Torx® head screws



720TX/C6
T30-T40-T45
T50-T55-T60

1 007200483

250x100x35 mm - 850 g

720ME

impact socket drivers for hexagon screws



mm	L mm	
5	60	3 007200505
6	60	3 007200506
8	60	3 007200508
10	68	3 007200510
12	68	3 007200512
14	78	3 007200514
17	78	3 007200517
19	78	3 007200519

720ME/C8

8 impact socket drivers for hexagon screws



720ME/C8
5-6-8-10-12
14-17-19 mm

1 007200525

270x120x45 mm - 1710 g

720/15

impact adaptor, 1/2" female and 3/8" male drives



720/15	1/2	3/8	L mm	
	<input type="checkbox"/>	<input type="checkbox"/>	37,5	3 007200810



Always apply torque loads evenly and progressively to avoid breakage and any possible injury.

720/16

impact adaptor, 1/2" female and 3/4" male drives



720/16	1/2	3/4	L mm	
	<input type="checkbox"/>	<input type="checkbox"/>	44	3 007200814

720/20

1/2" drive impact extension bar

12"



720/20	L mm	3	007200818
	75		

720/21

1/2" drive impact extension bar

12"



720/21	L mm	3	007200822
	125		

720/25

1/2" drive impact universal joint

12"



720/25	L mm	2	007200830
	72		

720/C6

6 impact sockets

12"



720/C6		1	007200910
	13-14-17-19-22-24 mm		

195x80x55 mm - 1100 g

720/C12

12 impact sockets

12"



720/C12		1	007200912
	10-11-12-13-14-17 19-22-24-27-30-32 mm		

195x80x55 mm - 2000 g

720T

impact torsion bars
for motor vehicle wheel nuts

12"



Nm	■		
90	1/2"	1	007200760
100	1/2"	1	007200762
110	1/2"	1	007200764
120	1/2"	1	007200766



720T/B4	1	007200780
---------	---	-----------

720/OR... - 720/SP...

rubber O-rings and locking pins
for impact sockets

12"

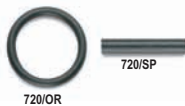

720/OR1	10	007200923
720/OR2	10	007200924
720/SP1	10	007200913
720/SP2	10	007200914

727PI/16

impact bit holder for item 727/ES16
and 727/ES16TX

3/4"



727PI/16	2	007270016
----------	---	-----------

727/ES16

impact hexagon bits, 16 mm drive

3/4"



mm		
10	2	007270110
12	2	007270112
13	2	007270113
14	2	007270114
16	2	007270116
17	2	007270117
18	2	007270118
19	2	007270119
22	2	007270122

727/ES16TX

impact bits for Torx® head screws,
16 mm drive

3/4"



T55	2	007270355
T60	2	007270360
T70	2	007270370

727PI/22

impact bit holder for item 727/ES22 and
727/ES22TX

1"



727PI/22	2	007270022
----------	---	-----------

727/ES22

impact hexagon bits, 22 mm drive

1"



mm		
19	2	007270219
22	2	007270222
24	2	007270224
27	2	007270227
30	2	007270230
32	2	007270232

727/ES22TX

impact bits for Torx® head screws,
22 mm drive

1"



T80	2	007270480
T90	2	007270490
T100	2	007270500



727/C16

12 impact bits and 4 accessories



727/C16 1 007270900

- 727PI/16
- 727/ES16 14-17-19 mm
- 727/ES16TX T55-T60-T70
- 727PI/22
- 727/ES22 22-24-27 mm
- 727/ES22TX T80-T90-T100
- 96BPC 3-4 mm
- 335x145x60 mm - 3560 g

727PI/32

impact bit holder
for item 727/ES32



727PI/32 1 007270032

727/ES32

impact hexagon bit,
32 mm drive

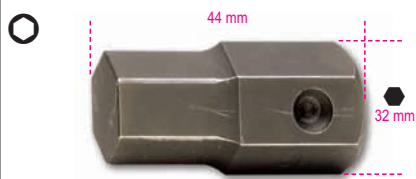

mm	
19	2 007270519
22	2 007270522
24	2 007270524
27	2 007270527
30	2 007270530
32	2 007270532
36	2 007270536

728

impact sockets, standard series



UNI/ISO 2725 DIN 3129

mm	D mm	L mm	
17	30,0	51	2 007280017
18	31,0	51	2 007280018
19	32,5	51	2 007280019
21	35,0	51	2 007280021
22	36,0	51	2 007280022
23	37,5	51	2 007280023
24	38,5	51	2 007280024
27	42,5	53	2 007280027
28	44,0	53	2 007280028
30	46,0	53	2 007280030
32	48,5	57	2 007280032
33	50,0	57	2 007280033
34	51,0	57	2 007280034
35	52,5	57	2 007280035
36	53,5	57	2 007280036
38	56,0	57	1 007280038
41	60,0	58	1 007280041
46	66,0	62	1 007280046
50	71,0	68	1 007280050
55	77,5	71	1 007280055
60	83,0	73	1 007280060

728FTX

impact sockets, for Torx® head screws

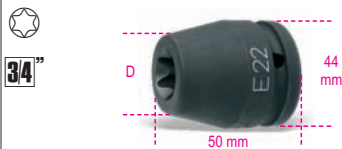

	D mm	
E20	28,5	2 007280420
E22	30,0	2 007280422
E24	32,5	2 007280424

728L

impact sockets, long series



mm	D mm	
19	32,5	2 007280319
21	35,0	2 007280321
22	36,0	2 007280322
24	38,5	2 007280324
26	41,0	2 007280326
27	42,5	2 007280327
30	46,0	2 007280330
32	48,5	2 007280332
33	50,0	2 007280333
34	51,0	2 007280334
36	53,5	2 007280336
38	56,0	2 007280338
41	60,0	2 007280341

728LS

impact sockets, long slim series

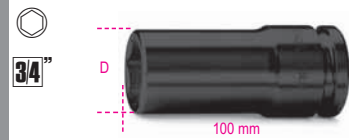

mm	D mm	
17	28,0	2 007280517
19	30,5	2 007280519
22	34,3	2 007280522
24	36,8	2 007280524
27	40,5	2 007280527
30	44,3	2 007280530
32	46,8	2 007280532
33	48,0	2 007280533
36	51,8	2 007280536

728LS/S3

set of 3 impact sockets item 728LS



728/15

impact adaptor, 3/4" female
and 1/2" male drives

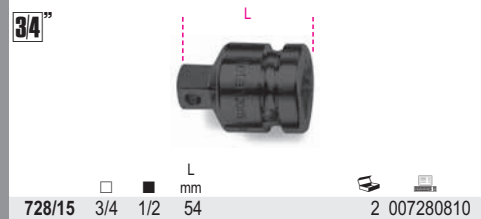

Always apply torque loads evenly and progressively to avoid breakage and any possible injury.

728/16

impact adaptor, 3/4" female and 1" male drives



728/21

3/4" drive impact extension bar



728/22

3/4" drive impact extension bar



728/22	L mm	2	007280825
	250		

728/25

3/4" drive impact universal joint



728/25	L mm	1	007280830
	107,5		

728/C10

10 impact sockets



728/C10	17-19-22-24-27-30	32-36-41-46 mm	1	007280910

275x120x65 mm - 5700 g

728/OR - 728/SP

rubber O-rings and locking pins for impact sockets



728/OR	10	007280926
728/SP	10	007280916

729

impact sockets, standard series

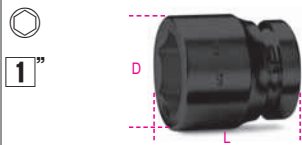

UNI/ISO 2725 DIN 3129

mm	D mm	L mm	1	007290024
24	41,5	58		
27	45,0	60		007290027
30	49,0	62		007290030
32	51,5	63		007290032
33	52,5	63		007290033

mm	D mm	L mm	1	007290034
34	54,0	63		
36	56,5	66		007290036
38	59,0	66		007290038
41	62,5	68		007290041
46	69,0	72		007290046
50	74,0	76		007290050
55	80,0	84		007290055
60	86,5	88		007290060
65	92,5	92		007290065
70	99,0	96		007290070
75	105,0	102		007290075
80	111,5	102		007290080

729L

impact sockets, long series



mm	D mm	L mm	1	007290324
24	41,5	108		
27	45,0	108		007290327
30	49,0	108		007290330
32	51,5	108		007290332
33	52,2	108		007290333
34	54,0	108		007290334
36	56,5	108		007290336
41	62,5	108		007290341
46	69,0	108		007290346
50	74,0	108		007290350
55	80,0	108		007290355
60	86,5	108		007290360
65	92,5	108		007290365
70	99,0	108		007290370
75	105,0	108		007290375
80	111,5	108		007290380

729LS

impact sockets, long slim series



mm	D mm	L mm	1	007290522
22	36,0	108		
24	38,5	108		007290524
27	42,3	108		007290527
30	46,0	108		007290530
32	48,5	108		007290532
33	49,8	108		007290533
36	53,5	108		007290536

729/15

impact adaptor, 1" female and 3/4" male drives



729/15	1	3/4	66,5	1	007290810



Always apply torque loads evenly and progressively to avoid breakage and any possible injury.

729/16

impact adaptor, 1" female and 1.1/2" male drives



729/16	1	1.1/2	88	1	007290813

729/21

1" drive impact extension bar



729/21	L mm	1	007290815
	175		

729/22

1" drive impact extension bar



729/22	L mm	1	007290825
	330		

729/25

1" drive impact universal joint



729/25	L mm	1	007290830
	130		

729/OR... - 729/SP...

rubber O-rings and locking pins for impact sockets



729/OR1	5	007290927
729/OR2	5	007290928
729/SP1	5	007290917
729/SP2	5	007290918

730

impact sockets, standard series

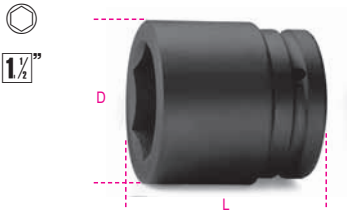

UNI/ISO 2725 DIN 3129

mm	D mm	L mm		
50	81	87	1	007300050
55	88	90	1	007300055
60	94	95	1	007300060
65	100	100	1	007300065
70	106	105	1	007300070
75	113	110	1	007300075
80	119	115	1	007300080
85	125	120	1	007300085
90	132	125	1	007300090
95	138	125	1	007300095
100	144	130	1	007300100
105	150	135	1	007300105
110	157	140	1	007300110
115	163	140	1	007300115
120	169	145	1	007300120
125	175	145	1	007300125

730/15

adaptor



730/15	1.1/2	1	L mm	
			105	1 007300810



Always apply torque loads evenly and progressively to avoid breakage and any possible injury.

733/15

adaptor



733/15	2.1/2	1.1/2	L mm	
			156	1 007330810

850BM

magnetic bit holder with handle



L1 mm	L mm		
125	240	2	008500010

850BM/C

magnetic bit holder with handle, short series



L1 mm	L mm		
45	160	2	008500020

851SR

magnetic quick release bit holder with handle



L1 mm	L mm		
110	230	2	008510001

855

bit holder with handle, with reversible ratchet



L1 mm	L mm		
62	187	1	008550001

855T

T-handle bit holder with universal quick release and reversible ratchet on long side



L1 mm	L mm		
135	185	1	008550050

861LP

bits for slotted head screws



ISO 2351-1
ISO 1173 C 6,3

SxA mm		
0,5x3	10	008610005
0,6x4,5	10	008610010
0,8x5,5	10	008610015
1x5,5	10	008610020
1,2x6,5	10	008610025
1,2x8	10	008610028
1,6x8	10	008610030

861PH

bits for cross head Phillips® screws



ISO 2351-2
ISO 1173 C 6,3

PH	L mm		
0	25	10	008610200
1	25	10	008610205
2	25	10	008610210
2L	50	10	008610213
3	25	10	008610215
4	32	10	008610220

861PH/C

bits for cross head Phillips® screws



ISO 2351-2
ISO 1173 C 6,3

PH	L mm		
0	25	200	008610250
1	25	200	008610255
2	25	200	008610260
2L	50	100	008610263
3	25	200	008610265
4	32	100	008610270

861PZ

bits for cross head Pozidriv®-Supadriv® screws



ISO 2351-2
ISO 1173 C 6,3

PZ	L mm		
1	25	10	008610300
2	25	10	008610305
2L	50	10	008610308
3	25	10	008610310
4	32	10	008610315

861PZ/C

bits for cross head Pozidriv®-Supadriv® screws



ISO 2351-2
ISO 1173 C 6,3

PZ	L mm		
1	25	200	008610350
2	25	200	008610355
2L	50	100	008610358
3	25	200	008610360
4	32	100	008610365

861PE

hexagon bits for power drivers



ISO 2351-3
ISO 1173 C 6,3

mm		
2	10	008610100
2,5	10	008610105
3	10	008610110
4	10	008610115
5	10	008610120
6	10	008610125
8	10	008610130
10	10	008610135

861TX

bits for Torx® head screws



ISO 1173 C 6,3

T6	10	008610400
T7	10	008610405
T8	10	008610410
T9	10	008610415
T10	10	008610420
T15	10	008610425
T20	10	008610430
T25	10	008610435
T27	10	008610440
T30	10	008610445
T40	10	008610450

861TX/C

bits for Torx® head screws



ISO 1173 C 6,3

T10	200	008610470
T15	200	008610475
T20	200	008610480
T25	200	008610485
T27	200	008610490
T30	200	008610495
T40	200	008610499

861RTX

bits for Tamper Resistant Torx® head screws



ISO 1173 C 6,3

T9	10	008610500
T10	10	008610505
T15	10	008610510
T20	10	008610515
T25	10	008610520
T27	10	008610525
T30	10	008610530
T40	10	008610535

861TRW

bits for Tri-Wing® head screws



ISO 1173 C 6,3

GR		
1	10	008610601
2	10	008610602
3	10	008610603
4	10	008610604
5	10	008610605
6	10	008610606

861TQS

bits for Torq-Set® head screws



ISO 1173 C 6,3

GR		
0	10	008610620
1	10	008610621
2	10	008610622
3	10	008610623
4	10	008610624
5	10	008610625
6	10	008610626
8	10	008610628
10	10	008610630

861SP

bits for Spanner screws

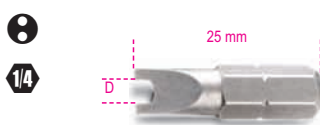

ISO 1173 C 6,3

SP	D mm	
4	1,5	10 008610650
6	2,4	10 008610653
8	2,8	10 008610656
10	3,3	10 008610658
12	3,9	10 008610660

861PHZ/S9

set of 8 bits with magnetic bit holder in plastic case



861PHZ/S9 1 008610340

			n.
861PH	PH1		1
	PH2		2
	PH3		1
861PZ	PZ1		1
	PZ2		2
	PZ3		1
882M1	○ 1/4 ● 1/4		

861PHZ/S31

set of 30 bits with magnetic bit holder in plastic case



861PHZ/S31 1 008610341

			n.
861PH	PH1		3
	PH2		9
	PH3		3
861PZ	PZ1		3
	PZ2		9
	PZ3		3
882M1	○ 1/4 ● 1/4		

861PE/S9

set of 8 hexagon bits with magnetic bit holder in plastic case



861PE/S9 1 008610139

861PE	○ 2 - 2,5 - 3 - 4 - 5 - 6 - 8 - 10 mm	
882M1	○ 1/4 ● 1/4	

861TX/S9

set of 8 bits with magnetic bit holder in plastic case

1/4



861TX/S9 1 008610391

- 861TX T8 - T10 - T15 - T20 - T25
T27 - T30 - T40
- 882M1 ○ 1/4 ● 1/4

861TX/S31

set of 30 bits with magnetic bit holder in plastic case

1/4



861TX/S31 1 008610393

- 861TX T6 - T7 - T8
T9 - T10 - T15 - T20
T25 - T27 - T30 - T40
- 882M1 ○ 1/4 ● 1/4

861PHT/S31

set of 30 bits with magnetic bit holder in plastic case

1/4



861PHT/S31 1 008610392

- 861PH PH1
PH2
- 861TX T10 - T15 - T20 - T25
T27 - T30 - T40
- 882M1 ○ 1/4 ● 1/4

861RTX/S9

set of 8 bits with magnetic bit holder in plastic case

1/4



861RTX/S9 1 008610536

- 861RTX T9 - T10 - T15 - T20
T25 - T27 - T30 - T40
- 882M1 ○ 1/4 ● 1/4

861MIX/S9

set of 8 bits with magnetic bit holder in plastic case

1/4



861MIX/S9 1 008610980

- 861LP 0,8x5,5 - 1,2x6,5 mm
- 861PH 1 - 2 - 3
- 861PZ 1 - 2 - 3
- 882M1 ○ 1/4 ● 1/4

861MIX/S31

set of 30 bits with magnetic bit holder in plastic case

1/4



861MIX/S31 1 008610984

- 861LP 0,5x3 - 0,6x4,5 - 0,8x5,5
1,0x5,5 - 1,2x6,5 mm
- 861PE 2 - 2,5 - 3 - 4 - 5 - 6 - 8 - 10 mm
- 861PH 0 - 1 - 2 - 3 - 4
- 861PZ 1 - 2 - 3 - 4
- 861RTX T9 - T10 - T15 - T20
T25 - T27 - T30 - T40
- 882M1 ○ 1/4 ● 1/4

861/C26N

26 bits and 2 accessories

1/4



861/C26N 1 008610960

- 861LP 0,5x3 - 0,8x5,5
1,0x5,5 - 1,2x6,5 mm
- 861PE 2 - 3 - 4 - 5 - 6 - 8 mm
- 861PH 0 - 1 - 2 - 3
- 861PZ 1 - 2 - 3
- 861TX T8 - T9 - T10 - T15 - T20
T25 - T27 - T30 - T40
- 194 ○ 1/4" - ○ 5/16"
- 850BM ○ 1/4"

270x120x45 mm - 950 g

861/C61P

61 bits and 1 magnetic quick release bit holder

1/4



861/C61P 1 008610978

- 861LP 0,5x3 - 0,6x4,5 - 0,8x5,5 - 1,0x5,5
1,2x6,5 - 1,2x8 - 1,6x8 mm
- 861PE 2 - 2,5 - 3 - 4 - 5 - 6 - 8 - 10 mm
- 861PH 0 - 1 - 2 - 3
- 861PZ 1 - 2 - 3
- 861TX T6 - T7 - T8 - T9 - T10 - T15
T20 - T25 - T27 - T30 - T40
- 861RTX T9 - T10 - T15 - T20 - T25
T27 - T30 - T40
- 861TRW 1 - 2 - 3 - 4 - 5 - 6
- 861TQS 0 - 1 - 2 - 3 - 4 - 5 - 6 - 8 - 10
- 861SP 4 - 6 - 8 - 10 - 12
- 851SR ○ 1/4"

270x120x45 mm - 975 g



862LP

bits for slotted head screws



ISO 2351-1
ISO 1173 E 6,3

SxA mm		
0,5x3	5	008620005
0,6x4,5	5	008620010
0,8x5,5	5	008620015
1x5,5	5	008620020
1,2x6,5	5	008620025
1,2x8	5	008620030
1,6x8	5	008620035

862PH

bits for cross head Phillips® screws



ISO 2351-2
ISO 1173 E 6,3

PH		
1	5	008620200
2	5	008620205
3	5	008620210

862PH/L

bits for cross head Phillips® screws



ISO 2351-2
ISO 1173 E 6,3

PH		
1	5	008620230
2	5	008620232
3	5	008620234

862PZ

bits for cross head Pozidriv®-Supadriv® screws



ISO 2351-2
ISO 1173 E 6,3

PZ		
1	5	008620300
2	5	008620305
3	5	008620310

862PE

hexagon bits for power drivers



ISO 2351-3
ISO 1173 E 6,3

mm		
3	5	008620103
4	5	008620104
5	5	008620105
6	5	008620106
8	5	008620108

862TX

bits for Torx® head screws



ISO 1173 E 6,3

T		
T9	5	008620509
T10	5	008620510
T15	5	008620515
T20	5	008620520
T25	5	008620525
T27	5	008620527
T30	5	008620530
T40	5	008620540

862TX/L

bits for Torx® head screws



ISO 1173 E 6,3

T		
T9	5	008620559
T10	5	008620560
T15	5	008620565
T20	5	008620570
T25	5	008620575
T27	5	008620577
T30	5	008620580
T40	5	008620590

862F

magnetic bits, hexagon sockets



ISO 1173 E 6,3

mm		
5,5	5	008620405
6	5	008620406
7	5	008620407
8	5	008620408
10	5	008620410
12	5	008620412
13	5	008620413

866LP

bits for slotted head screws



ISO 2351-1
ISO 1173 C 8

SxA mm		
1x5,5	10	008660005
1,2x6,5	10	008660010
1,6x8	10	008660015
1,6x10	10	008660020
2x12	10	008660025

866PH

bits for cross head Phillips® screws



ISO 2351-2
ISO 1173 C 8

PH	L mm	
1	32	10 008660200
2	32	10 008660205
3	32	10 008660210
4	38	10 008660215

866PZ

bits for cross head Pozidriv®-Supadriv® screws



ISO 2351-2
ISO 1173 C 8

PZ	L mm	
1	32	10 008660300
2	32	10 008660305
3	32	10 008660310
4	38	10 008660315

866PE

hexagon bits for power drivers



ISO 2351-3
ISO 1173 C 8

mm		
3	10	008660100
4	10	008660105
5	10	008660110
6	10	008660115
8	10	008660120
10	10	008660125

866TX

bits for Torx® head screws

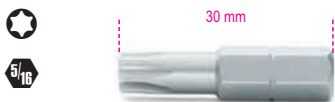

ISO 1173 C 8

T20	10	008660400
T25	10	008660405
T27	10	008660410
T30	10	008660415
T40	10	008660420
T45	10	008660425
T50	10	008660430
T55	10	008660435

867PE

hexagon bits

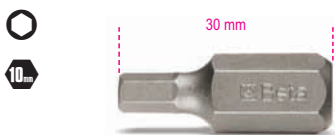

mm		
4	5	008670104
5	5	008670105
6	5	008670106
7	5	008670107
8	5	008670108
10	5	008670110
12	5	008670112

867PE/L

hexagon bits



mm		
4	5	008670154
5	5	008670155
6	5	008670156
7	5	008670157
8	5	008670158
10	5	008670160
12	5	008670162

867XZN

bits with XZN® profile

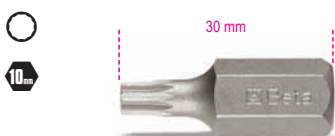

M5	5	008670205
M6	5	008670206
M8	5	008670208
M10	5	008670210
M12	5	008670212

867XZN/L

bits with XZN® profile



M5	5	008670255
M6	5	008670256
M8	5	008670258
M10	5	008670260
M12	5	008670262

867TX

bits for Torx® head screws

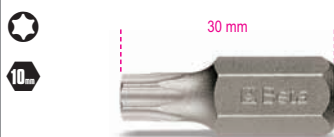

T20	5	008670400
T25	5	008670405
T30	5	008670410
T40	5	008670415
T45	5	008670420
T50	5	008670425
T55	5	008670430

867TX/L

bits for Torx® head screws



T20	5	008670450
T25	5	008670455
T30	5	008670460
T40	5	008670465
T45	5	008670470
T50	5	008670475
T55	5	008670480

867RTX

bits for Tamper Resistant Torx® head screws

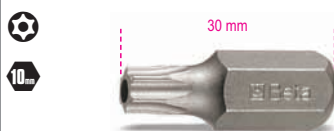

T20	5	008670500
T25	5	008670505
T30	5	008670510
T40	5	008670515
T45	5	008670520
T50	5	008670525
T55	5	008670530

867RTX/L

bits for Tamper Resistant Torx® head screws



T20	5	008670550
T25	5	008670555
T30	5	008670560
T40	5	008670565
T45	5	008670570
T50	5	008670575
T55	5	008670580

867/...

bit holder sockets for item 867



867/1	10 mm	3/8"	5	008670600
867/2	10 mm	1/2"	5	008670601

867/C52

52 hexagon bits, 10 mm and 2 accessories



867/C52	1	008670901
---------	---	-----------

	867PE	4-5-6-7-8-10-12 mm
	867PE/L	4-5-6-7-8-10-12 mm
	867XZN	M5-M6-M8-M10-M12
	867XZN/L	M5-M6-M8-M10-M12
	867TX	T20-T25-T30-T40-T45-T50-T55
	867TX/L	T20-T25-T30-T40-T45-T50-T55
	867RTX	T20-T25-T30-T40-T45-T50-T55
	867RTX/L	T20-T25-T30-T40-T45-T50-T55
	867/1	10 mm - 3/8"
	867/2	10 mm - 1/2"

880

bit holder with retaining ring for drivers



ISO 1173 A 5,5

	○	●	L mm	D mm		
880	1/4	5,5	57	11	5	008800001

880M

bit holder with retaining ring for drivers



ISO 1173 A 5,5

	○	●	L mm	D mm		
880M	1/4	5,5	72	10,5	5	008800005

882

bit holder with retaining ring for drivers

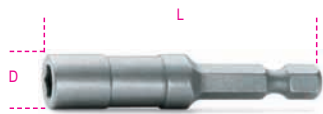

ISO 1173 C 6,3

	○	●	L mm	D mm		
882	1/4	1/4	57	11	5	008820001

882M

magnetic bit holder



ISO 1173 C 6,3

	○	●	L mm	D mm		
882M	1/4	1/4	75	11	5	008820005

882M1

magnetic bit holder



ISO 1173 C 6,3

	○	●	L mm	D mm		
882M1	1/4	1/4	50	11	5	008820006

882SR

quick release bit holders for drivers



ISO 1173 C 6,3

	○	●	L mm			
	1/4	1/4	50	11	5	008820105
	1/4	1/4	75		5	008820107

884

bit holder with retaining ring for drivers



	○	●	L mm	D mm		
884	1/4	5/16	65	11	5	008840001

892

adaptors for drivers



	■	●	L			
892/0	1/4	1/4	25	5	008920000	
* 892/1	1/4	5,5	50	5	008920001	
* 892/2	3/8	5,5	50	5	008920002	
° 892/3	1/4	1/4	50	5	008920003	
° 892/4	3/8	1/4	50	5	008920004	
892/5	1/4	5/16	75	5	008920005	
892/6	3/8	5/16	75	5	008920006	

895socket holder for bits
item 861 - 862 - 866

DIN 7427

	○	□	L mm	D mm		
895/1	1/4	1/4	22	12	5	008950000
895/3	1/4	3/8	30	17,3	5	008950001
895/4	5/16	3/8	38	18	5	008950002
895/5	1/4	1/2	38	22	5	008950005
895/6	5/16	1/2	38	22	5	008950003

897

flexible bit holder with handle



	L mm	L1 mm		
	280	154	2	008970010

897L

flexible bit holder with handle, long model



	L mm	L1 mm		
	500	380	2	008970015

900

hexagon hand sockets



UNI/ISO 2725 DIN 3124

	D mm	L mm		
4	6,7	25	10	009000040
4,5	7,4	25	10	009000045
5	8,0	25	10	009000050
5,5	8,6	25	10	009000055
6	9,3	25	10	009000060
7	10,4	25	10	009000070
8	11,8	25	10	009000080
9	12,7	25	10	009000090
10	14,2	25	10	009000100
11	15,8	25	10	009000110
12	17,2	25	10	009000120
13	18,0	25	10	009000130
14	20,0	25	10	009000140

900/SB13
4-4,5-5-5,5-6-7-8-9
10-11-12-13-14 mm

1 009000150

900MB

bi-hex hand sockets



UNI/ISO 2725 DIN 3124

	D mm	L mm		
4	7	22	5	009000160
5	7,7	22	5	009000161
5,5	8,3	22	5	009000162
6	9,0	22	5	009000163
7	10,2	22	5	009000164
8	11,3	22	5	009000165
9	13,0	22	5	009000166
10	14,3	22	5	009000167
11	16,0	22	5	009000168
12	17,4	22	5	009000169
13	18,0	22	5	009000170
14	19,3	24	5	009000171

14"



900MB/SB12
4-5-5,5-6-7-8-9-10
11-12-13-14 mm

1 009000179

900L

hexagon hand sockets, long series



14"



UNI/ISO 2725 DIN 3124

mm	D mm	L mm	
4	6,5	50	5 009000181
4,5	7,0	50	5 009000182
5	7,5	50	5 009000183
5,5	8,5	50	5 009000184
6	9,5	50	5 009000185
7	10,5	50	5 009000186
8	12,0	50	5 009000187
9	13,0	50	5 009000188
10	14,0	50	5 009000189
11	16,0	50	5 009000190
12	17,5	50	5 009000191
13	17,5	50	5 009000192
14	20,0	50	5 009000193

900MB/L

bi-hex hand sockets, long series



14"



UNI/ISO 2725 DIN 3124

mm	D mm	L mm	
5	8,0	50	5 009000211
6	9,3	50	5 009000212
7	10,9	50	5 009000213
8	11,6	50	5 009000214
9	13,0	50	5 009000215
10	14,3	50	5 009000216
11	16,0	50	5 009000217
12	17,4	50	5 009000218
13	18,0	50	5 009000219
14	19,0	50	5 009000220

900AS

hexagon hand sockets



14"



	D mm	L mm	
5/32	6,5	22	5 009000349
3/16	7,4	22	5 009000340
7/32	8,6	22	5 009000345

	D mm	L mm	
1/4	9,6	22	5 009000350
9/32	10,4	22	5 009000355
5/16	11,8	22	5 009000360
11/32	12,7	22	5 009000365
3/8	14,2	22	5 009000370
7/16	15,8	22	5 009000375
1/2	17,2	22	5 009000380
9/16	20,0	24	5 009000385

900AS/MB

bi-hex hand sockets



14"



SAE AS 954E

	D mm	L mm	
3/16	8,0	22	5 009000390
7/32	8,6	22	5 009000391
1/4	9,6	22	5 009000392
9/32	10,0	22	5 009000393
5/16	11,9	22	5 009000394
11/32	12,0	22	5 009000395
3/8	13,9	22	5 009000396
7/16	15,2	22	5 009000397
1/2	17,2	22	5 009000398
9/16	19,0	24	5 009000399

900AS/L

hexagon hand sockets, long series



14"



	D mm	L mm	
3/16	7,0	50	5 009000301
7/32	8,5	50	5 009000303
1/4	9,8	50	5 009000305
9/32	10,5	50	5 009000307
5/16	12,0	50	5 009000309
11/32	13,0	50	5 009000311
3/8	14,0	50	5 009000313
7/16	16,0	50	5 009000315
1/2	17,5	50	5 009000317
9/16	20,0	50	5 009000319

900AS/MBL

bi-hex hand sockets, long series



14"



	D mm	L mm	
5/32	6,8	50	5 009000325
3/16	8,0	50	5 009000326
7/32	8,5	50	5 009000327
1/4	9,8	50	5 009000328

	D mm	L mm	
9/32	10,9	50	5 009000329
5/16	11,6	50	5 009000330
11/32	13,0	50	5 009000331
3/8	14,3	50	5 009000332
7/16	16,0	50	5 009000333
1/2	18,0	50	5 009000334
9/16	19,0	50	5 009000335

900FTX

hand sockets for Torx® head screws



14"



	D mm	D1 mm	
E4	5,4	11,2	5 009000404
E5	6,7	11,2	5 009000405
E6	7,7	11,2	5 009000406
E7	8,3	11,2	5 009000407
E8	9,6	11,2	5 009000408
E10	11,3	12,0	5 009000410

900LP

socket drivers for slotted head screws



14"



SxA mm	D mm	
0,8x4	12	10 009000605
1x5,5	12	10 009000610
1,2x6,5	12	10 009000615
1,2x8	13	10 009000620
1,6x10	14	10 009000625

900PH

socket drivers for cross head Phillips® screws



14"

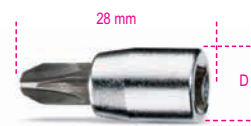

PH	D mm	
1	12	10 009000701
2	12	10 009000702
3	12	10 009000703
4	13	10 009000704

900ME

socket drivers for hexagon screws



mm	D mm		
2,5	12	10	009000502
3	12	10	009000503
4	12	10	009000504
5	12	10	009000505
6	12	10	009000506
7	13	10	009000507
8	13	10	009000508

900PT

socket drivers for 5-star head screws

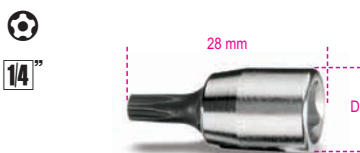

	D mm		
PT10	12	5	009000750
PT15	12	5	009000755
PT20	12	5	009000760
PT25	12	5	009000765
PT27	12	5	009000767
PT30	12	5	009000770

900TX

socket drivers for Torx® head screws

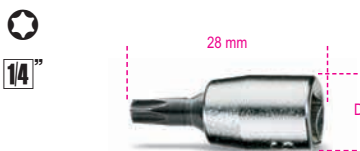

	D mm		
T9	12	5	009000720
T10	12	5	009000721
T15	12	5	009000722
T20	12	5	009000723
T25	12	5	009000724
T27	12	5	009000725
T30	12	5	009000726
T40	12	5	009000727

900/16

adaptor, 1/4" female and 3/8" male drives



UNI/ISO 3316 DIN 3123

	L mm		
1/4	3/8	22	5 009000814

900/...

1/4" female and male drive extension bars

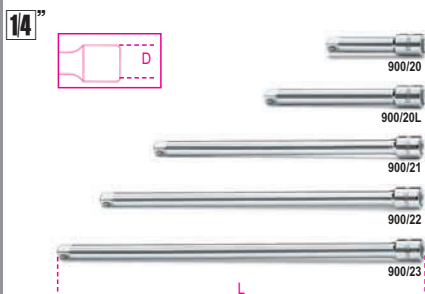

UNI/ISO 3316 DIN 3123

	L mm	D mm		
900/20	50	11,5	5	009000818
900/20L	100	11,5	5	009000819
900/21	150	11,5	5	009000822
900/22	250	11,5	5	009000823
900/23	350	11,5	5	009000824

900AN

1/4" wobble extension bars

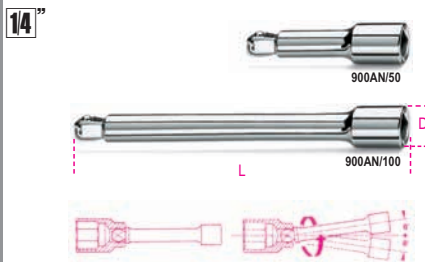

	L mm	D mm		
900AN/50	50	11,5	3	009000825
900AN/100	100	11,5	3	009000826

900FL

1/4" flexible universal extension bar

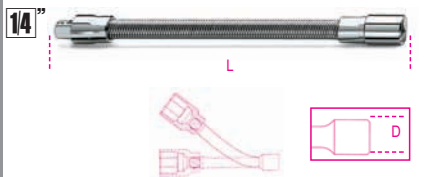

L mm	D mm		
150	12	3	009000828

900/25

1/4" drive universal joint



UNI/ISO 3316 DIN 3123

L mm	D mm		
41	12,5	5	009000830

900BG/30

1/4" drive spinner handle



UNI /ISO 3315 DIN 3122

L mm			
176	5	009000834	

900BG/30C

1/4" drive spinner handle



UNI /ISO 3315 DIN 3122

L mm			
128	5	009000833	

900/32

1/4" drive flexible handle



L mm	L1 mm		
280	154	2	009000839

900/35A

1/4" drive swivel handle



UNI/ISO 3315 DIN 3122

L mm			
148	5	009000840	

900M/35

1/4" swivel drive with metal handle



L mm			
130	3	009000845	

900/40

1/4" drive swivel T-handle

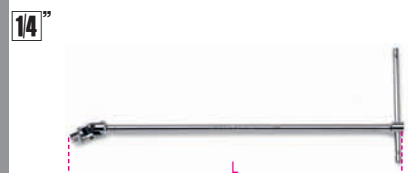

L mm			
390	5	009000843	

900/42

1/4" drive sliding T-handle

14"



UNI/ISO 3315 DIN 3122

L			
mm			
115	5	009000854	

900/55

1/4" drive reversible ratchet, 48 teeth

14"

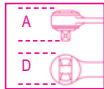

UNI/ISO 3315 DIN 3122

L	D	A	
mm	mm	mm	
125	25	18	5 009000870

900M/55

1/4" drive reversible ratchet with metal handle

14"



L	D	A	
mm	mm	mm	
110	22	18	3 009000905

900M/56

1/4" drive reversible swivelling ratchet with metal handle

14"

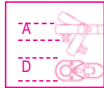

L	D	A	
mm	mm	mm	
165	25	18	3 009000907

900/C11

11 hexagon sockets, 20 bits and 8 accessories

14"

1/4"



900/C11 1 009000971

- 861LP 0,5x3 - 0,8x5,5
1x5,5 - 1,2x6,5 mm
- 861PE 3 - 4 - 5 - 6 - 8 mm
- 861PH 0 - 1 - 2 - 3
- 861TX T8 - T10 - T15 - T20
T25 - T30 - T40
- 895/1
- 900 5 - 5,5 - 6 - 7 - 8 - 9 - 10
11 - 12 - 13 - 14 mm
- 900/16 □ 1/4 - ■ 3/8
- 900/20 50 mm
- 900/21 150 mm
- 900/25
- 900BG/30
- 900/42
- 900/55

270x120x45 mm - 1200 g

900/C13-5

13 hexagon sockets and 5 accessories

14"



900/C13-5 1 009000953

- 900 4 - 4,5 - 5 - 5,5 - 6 - 7 - 8 - 9
10 - 11 - 12 - 13 - 14 mm
- 900/21 150 mm
- 900/25
- 900BG/30
- 900/42
- 900/55

270x120x45 mm - 1000 g

900/C13-8

13 hexagon sockets and 8 accessories

14"



900/C13-8 1 009000954

- 900 4 - 4,5 - 5 - 5,5 - 6 - 7 - 8 - 9
10 - 11 - 12 - 13 - 14 mm
- 900/16 □ 1/4 - ■ 3/8
- 900/20 50 mm
- 900/21 150 mm
- 900/25
- 900BG/30
- 900/35A
- 900/42
- 900/55

270x120x45 mm - 1100 g

900MB/C19

11 bi-hex sockets and 8 accessories

14"



900MB/C19 1 009000977

- 900MB 5 - 5,5 - 6 - 7 - 8 - 9 - 10 - 11
12 - 13 - 14 mm
- 900/16 □ 1/4 - ■ 3/8
- 900/20 50 mm
- 900/21 150 mm
- 900/25
- 900BG/30
- 900/35A
- 900/42
- 900/55

270x120x45 mm - 1080 g



900/C24

13 hexagon sockets, 11 socket drivers and 6 accessories

1/4"



900/C24 1 009000956

	900	4 - 4,5 - 5 - 5,5 - 6 - 7 - 8 - 9 10 - 11 - 12 - 13 - 14 mm
	900LP	0,8x4 - 1,2x6,5 - 1,2x8 mm
	900PH	PH1 - PH2 - PH3
	900ME	3 - 4 - 5 - 6 - 8 mm
	900/20	50 mm
	900/21	150 mm
	900/25	
	900BG/30	
	900/42	
	900/55	
≡ 270x120x45 mm - 📦 1150 g		

900MB/C28

11 bi-hex sockets, 11 socket drivers and 6 accessories

1/4"



900MB/C28 1 009000979

	900MB	5 - 5,5 - 6 - 7 - 8 - 9 - 10 - 11 12 - 13 - 14 mm
	900LP	0,8x4 - 1,2x6,5 - 1,2x8 mm
	900PH	PH1 - PH2 - PH3
	900ME	3 - 4 - 5 - 6 - 8 mm
	900/20	50 mm
	900/21	150 mm
	900/25	
	900BG/30	
	900/42	
	900/55	
≡ 270x120x45 mm - 📦 1130 g		

900AS/C10 - /MB-C17

10 sockets and 7 accessories

1/4"



900AS/C10 1 009000961

	900AS	3/16 - 7/32 - 1/4 - 9/32 - 5/16 11/32 - 3/8 - 7/16 - 1/2 - 9/16
	900/20	50 mm
	900/21	150 mm
	900/25	
	900BG/30	
	900/35A	
	900/42	
	900/55	
≡ 270x120x45 mm - 📦 1080 g		

900AS/MB-C17



1 009000981

	900AS/MB	3/16 - 7/32 - 1/4 - 9/32 - 5/16 11/32 - 3/8 - 7/16 - 1/2 - 9/16
	900/20	50 mm
	900/21	150 mm
	900/25	
	900BG/30	
	900/35A	
	900/42	
	900/55	
≡ 270x120x45 mm - 📦 1080 g		

900AS/C17-MBM

10 bi-hex sockets and 7 accessories for aeronautical maintenance

1/4"



900AS/C17-MBM 1 009000982

	900AS/MB	3/16 - 7/32 - 1/4 - 9/32 - 5/16 11/32 - 3/8 - 7/16 - 1/2 - 9/16
	900/20	50 mm
	900/21	150 mm
	900/25	
	900BG/30	
	900M/35	
	900/42	
	900M/55	
≡ 270x120x45 mm - 📦 1200 g		

900/C30

7 hexagon sockets, 21 bits and 2 accessories

1/4"

1/4"



900/C30 1 009000958

	855	1/4"
	861LP	0,8x5,5 - 1x5,5 - 1,2x6,5 mm
	861PH	1 - 2(x2) - 3
	861PE	2 - 2,5 - 3 - 4 - 5 mm
	861PZ	1 - 2(x2) - 3
	861RTX	T9 - T10 - T15 - T20 - T25
	892/3	■ 1/4 ● 1/4
	900	5 - 5,5 - 6 - 7 - 8 - 10 - 13 mm
≡ 270x120x45 mm - 📦 950 g		

902R/C6

6 adaptors for socket drivers



902R/C6 1 009020814

	900/16	□ 1/4 - ■ 3/8
	910/15	□ 3/8 - ■ 1/4
	910/16	□ 3/8 - ■ 1/2
	920/15	□ 1/2 - ■ 3/8
	920/16	□ 1/2 - ■ 3/4
	928/15	□ 3/4 - ■ 1/2
≡ 170x100x35 mm - 📦 600 g		

910A

hexagon hand sockets

3/8"



UNI/ISO 2725 DIN 3124

mm	D mm	L mm	Icon
6	9,5	28	5 009100006
7	10,7	28	5 009100007
8	12,1	28	5 009100008
9	13,2	28	5 009100009
10	14,6	29	5 009100010
11	15,8	29	5 009100011

mm	D mm	L mm		
12	17,2	30	5	009100012
13	18,4	31	5	009100013
14	19,7	32	5	009100014
15	20,9	32	5	009100015
16	22,2	33	5	009100016
17	23,2	33	5	009100017
18	24,7	34	5	009100018
19	25,8	35	5	009100019
20	27,2	35	5	009100020
21	28,2	36	5	009100021
22	29,7	37	5	009100022

38"

**910A/SB17**

6-7-8-9-10-11-12
13-14-15-16-17
18-19-20-21-22 mm

1 009100030

910B

bi-hex hand sockets

38"



UNI/ISO 2725 DIN 3124

mm	D mm	L mm		
6	9,5	28	5	009100106
7	10,7	28	5	009100107
8	12,1	28	5	009100108
9	13,2	28	5	009100109
10	14,6	29	5	009100110
11	15,8	29	5	009100111
12	17,2	30	5	009100112
13	18,4	31	5	009100113
14	19,7	32	5	009100114
15	20,9	32	5	009100115
16	22,2	33	5	009100116
17	23,2	33	5	009100117
18	24,7	34	5	009100118
19	25,8	35	5	009100119
20	27,2	35	5	009100120
21	28,2	36	5	009100121
22	29,7	37	5	009100122

38"

**910B/SB17**

6-7-8-9-10-11-12
13-14-15-16-17
18-19-20-21-22 mm

1 009100130

910AL

hexagon hand sockets, long series

38"



UNI/ISO 2725 DIN 3124

mm	D mm	L mm		
8	12,0	55	5	009100158
9	13,0	55	5	009100159
10	14,5	55	5	009100160
11	16,0	55	5	009100161
12	17,0	55	5	009100162
13	18,0	55	5	009100163
14	20,0	55	5	009100164
15	21,0	55	5	009100165
16	22,0	55	5	009100166
17	23,5	55	5	009100167
18	24,5	55	5	009100168
19	25,0	55	5	009100169
21	27,0	65	5	009100171
22	29,0	65	5	009100172

**910AL/SB14**

8-9-10-11-12-13-14
15-16-17-18-19-21-22 mm

1 009100174

910BL

bi-hex hand sockets, long series

38"



UNI/ISO 2725 DIN 3124

mm	D mm	L mm		
8	12,0	55	5	009100308
9	13,0	55	5	009100309
10	14,5	55	5	009100310
11	16,0	55	5	009100311
12	17,0	55	5	009100312
13	18,0	55	5	009100313
14	20,0	55	5	009100314
15	21,0	55	5	009100315
16	22,0	55	5	009100316
17	23,5	55	5	009100317
18	24,5	55	5	009100318
19	25,0	55	5	009100319
21	27,0	65	5	009100321
22	29,0	65	5	009100322

Beta

SHOP
in Shop

38"

**910BL/SB14**

8-9-10-11-12-13
14-15-16-17-18
19-21-22 mm

1 009100340

910B/SN

swivel end bi-hex hand sockets

38"



mm	D mm	L mm		
10	14,5	48,5	5	009100230
11	15,8	49,5	5	009100231
12	17,0	50,0	5	009100232
13	18,3	51,0	5	009100233
14	19,5	51,0	5	009100234
15	20,8	53,5	5	009100235
16	22,0	53,5	5	009100236
17	23,3	54,5	5	009100237
18	24,5	54,5	5	009100238
19	25,8	56,5	5	009100239

910A/AS

hexagon hand sockets

38"



	D mm	L mm		
1/4	10,3	26	5	009100276
5/16	11,9	26	5	009100278
11/32	13,3	26	5	009100279
3/8	13,9	26	5	009100280
7/16	15,8	26	5	009100281
1/2	17,9	26	5	009100283
9/16	19,5	27	5	009100284
19/32	20,6	27	5	009100285
5/8	21,9	28	5	009100286
11/16	24,6	30	5	009100287
3/4	25,9	30	5	009100289
13/16	27,9	32	5	009100291
7/8	29,6	32	5	009100292

**910A-AS/SB13**

1/4-5/16-11/32-3/8-7/16
1/2-9/16-19/32-5/8-11/16
3/4-13/16-7/8

1 009100295

910AS

bi-hex hand sockets

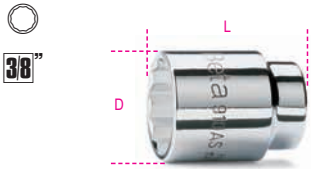

Hex	D mm	L mm	Part No.
1/4	9,5	28	5 009100201
5/16	12,1	28	5 009100202
11/32	13,2	28	5 009100203
3/8	14,6	29	5 009100204
7/16	15,8	29	5 009100205
1/2	18,4	31	5 009100206
9/16	19,7	32	5 009100207
19/32	20,9	32	5 009100208
5/8	22,2	33	5 009100209
11/16	24,7	34	5 009100210
3/4	25,8	35	5 009100211
13/16	28,2	36	5 009100212
7/8	29,7	37	5 009100213



910AS/SB13	1 009100215
1/4-5/16-11/32-3/8-7/16	
1/2-9/16-19/32-5/8-11/16	
3/4-13/16-7/8	

910AS/L

bi-hex hand sockets, long series

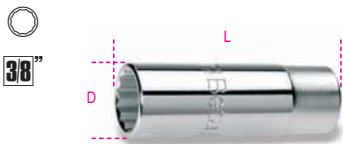

Hex	D mm	L mm	Part No.
1/4	10	55	5 009100350
5/16	12	55	5 009100351
3/8	14	55	5 009100352
7/16	16	55	5 009100353
1/2	18	55	5 009100354
9/16	20	55	5 009100355
19/32	21	55	5 009100356
5/8	22	55	5 009100357
11/16	23	55	5 009100359
3/4	25	55	5 009100360
13/16	27	65	5 009100362
7/8	29	65	5 009100363



910ASL/SB12	1 009100365
1/4-5/16-3/8-7/16	
1/2-9/16-19/32-5/8-11/16	
3/4-13/16-7/8	

910AS/SN

swivel end bi-hex hand sockets

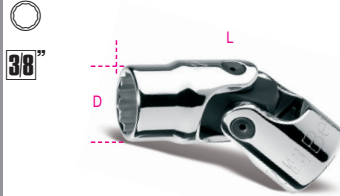

* SAE AS 954E

Hex	D mm	L mm	Part No.
* 3/8	14,0	48,0	5 009100260
* 7/16	15,8	51,0	5 009100261
* 1/2	18,3	51,0	5 009100262
* 9/16	19,5	51,0	5 009100263
* 5/8	22,0	53,5	5 009100264
11/16	24,5	54,5	5 009100265
3/4	25,8	56,5	5 009100266

910FTX

hand sockets for Torx® head screws



Hex	D mm	Part No.
E4	6,2	5 009100404
E5	7,0	5 009100405
E6	8,3	5 009100406
E7	8,9	5 009100407
E8	9,9	5 009100408
E10	12,0	5 009100410
E12	14,5	5 009100412
E14	15,8	5 009100414
E16	18,0	5 009100416



910FTX/SB9	1 009100430
E4-E5-E6-E7-E8	
E10-E12-14-E16	

910FTX/L

hand sockets for Torx® head screws, long series

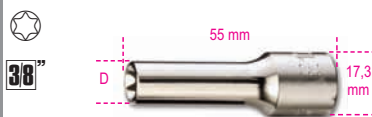

Hex	D mm	Part No.
E4	6,2	5 009100440
E5	7,0	5 009100441
E6	8,3	5 009100442
E7	8,9	5 009100443
E8	9,9	5 009100444
E10	12,0	5 009100445

38"



910FTX/LSB6	1 009100449
E4-E5-E6	
E7-E8-E10	

910LP

socket drivers for slotted head screws



SxA mm	Part No.
1x5,5	5 009100452
1,2x6,5	5 009100453
1,2x8	5 009100454
1,6x9	5 009100456

910PH

socket drivers for cross head Phillips® screws

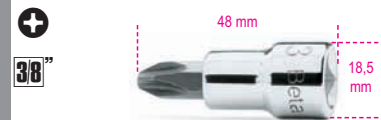

PH	Part No.
1	5 009100471
2	5 009100472
3	5 009100473
4	5 009100474

910LH/SB7

socket drivers for cross head Phillips® screws



910LH/SB7	1 009100479
910LP	1x5,5 - 1,2x6,5 - 1,2x8 - 1,6x9
910PH	PH1 - PH2 - PH3

910PE

socket drivers for hexagon screws

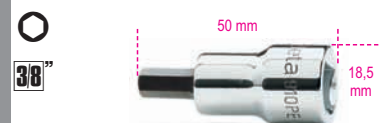

mm	Part No.
3	5 009100490
4	5 009100492
5	5 009100494
6	5 009100496
7	5 009100497
8	5 009100498
10	5 009100500

3/8"

910PE/SB7
3-4-5-6-7-8-10 mm



1 009100503

910ME

socket drivers for hexagon screws

3/8"

mm	D mm	Hand	Digital
4	18	5	009100504
5	18	5	009100505
6	18	5	009100506
7	18	5	009100507
8	19	5	009100508
10	20	5	009100510
12	20	5	009100512

910PT

socket drivers for 5-star head screws

3/8"

PT40	3	009100540
PT45	3	009100545
PT50	3	009100550

1/4"
3/8"

910PT/SB8
PT10-PT15-PT20-PT25
PT30-PT40-PT45-PT50



1 009100558

910TX

socket drivers for Torx® head screws

3/8"

T15	5	009100519
T20	5	009100520
T25	5	009100521
T27	5	009100522
T30	5	009100523
T40	5	009100524

3/8"

910TX/SB6
T15-T20-T25
T27-T30-T40



1 009100530

910CF

3/8" square drive crowfoot wrenches

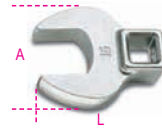
3/8"

mm	A mm	L mm	Hand	Digital
10	21,3	32,3	5	009100135
11	23,1	34,3	5	009100136
12	25,5	36,2	5	009100137
13	26,9	37,4	5	009100138
14	30,2	40,0	5	009100139
15	33,3	41,3	5	009100140
16	33,3	41,3	5	009100141
17	38,1	46,5	5	009100142
18	38,1	46,5	5	009100143
19	39,6	48,0	5	009100144

3/8"

910CF/SB10
10-11-12-13-14-15
16-17-18-19 mm



1 009100147

910/15

adaptor, 3/8" female
and 1/4" male drivers

3/8"

UNI/ISO 3316 DIN 3123

□	■	L mm	Hand	Digital
3/8	1/4	30	5	009100810



Always apply torque loads evenly
and progressively to avoid breakage
and any possible injury.

910/16

adaptor, 3/8" female
and 1/2" male drives

3/8"

UNI/ISO 3316 DIN 3123

□	■	L mm	Hand	Digital
3/8	1/2	32	5	009100814

910/21 - 910/22

3/8" drive extension bars

3/8"

UNI/ISO 3316 DIN 3123

	L mm	D mm	Hand	Digital
910/21	125	17	5	009100822
910/22	250	17	5	009100826

910AN

3/8" wobble extension bars

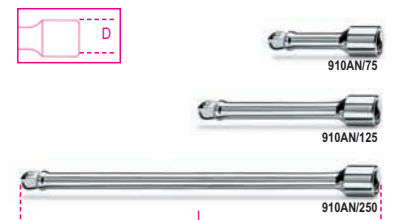
3/8"

	L mm	D mm	Hand	Digital
910AN/75	75	17	3	009100827
910AN/125	125	17	3	009100828
910AN/250	250	17	3	009100829

910/25

3/8" drive universal joint

3/8"

UNI/ISO 3316 DIN 3123

L mm	D mm	Hand	Digital
54,6	19	5	009100830

910M/35

3/8" swivel drive with metal handle

3/8"

UNI/ISO 3315 DIN 3122

L mm	Hand	Digital
250	3	009100839

910M/35L

3/8" swivel drive with metal handle, long version



L mm 380 2 009100841

Always apply torque loads evenly and progressively to avoid breakage and any possible injury.

910/36A

3/8" drive swivel handle



UNI/ISO 3315 DIN 3122 L mm 255 3 009100845

910/40

3/8" drive swivel T-handle



L mm 420 3 009100850

910/42

3/8" drive sliding T-handle



UNI/ISO 3315 DIN 3122 L mm 210 5 009100854

910/46

3/8" square drive with speed brace

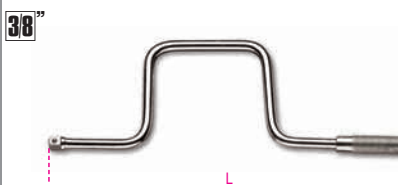

UNI/ISO 3315 DIN 3122 L mm 315 1 009100862

910/55

3/8" drive reversible ratchet 72 teeth



UNI/ISO 3315 DIN 3122

L mm 200 D mm 30 A mm 33 3 009100882

910/55Q

3/8" drive reversible ratchet 48 teeth



UNI/ISO 3315 DIN 3122

L mm 200 D mm 30 A mm 33 3 009100885

910M/55

3/8" drive reversible ratchet with metal handle



L mm 178 D mm 30 A mm 26 2 009100875

910M/56

3/8" drive reversible swivel ratchet with metal handle



L mm 265 D mm 31 A mm 29 2 009100887

910.../C10

10 sockets and 2 accessories



910A/C10 1 009100909

910A 6 - 7 - 8 - 10 - 11 - 12 13 - 14 - 17 - 19 mm 910/21 125 mm 910/55 270x120x45 mm - 1340 g

910B/C10 1 009100910

910B 6 - 7 - 8 - 10 - 11 - 12 13 - 14 - 17 - 19 mm 910/21 125 mm 910/55 270x120x45 mm - 1320 g

910A/C16...

16 hexagon sockets and 5 accessories



910A/C16 1 009100936

910A 6 - 7 - 8 - 9 - 10 - 11 - 12 - 13 14 - 15 - 16 - 17 - 18 - 19 21 - 22 mm 910/21 125 mm 910/22 250 mm 910/25 910/42 910/55 335x145x60 mm - 2360 g

910A/C16Q 1 009100932

-  **910A** 6 - 7 - 8 - 9 - 10 - 11 - 12 - 13
14 - 15 - 16 - 17 - 18 - 19
21 - 22 mm
 -  **910/21** 125 mm
 -  **910/22** 250 mm
 -  **910/25**
 -  **910/42**
 -  **910/55Q**
- ≡ 335x145x60 mm -  2360 g

910B/C16...

16 bi-hex sockets and 5 accessories

38"



910B/C16 1 009100937

-  **910B** 6 - 7 - 8 - 9 - 10 - 11 - 12 - 13
14 - 15 - 16 - 17 - 18 - 19
21 - 22 mm
 -  **910/21** 125 mm
 -  **910/22** 250 mm
 -  **910/25**
 -  **910/42**
 -  **910/55**
- ≡ 335x145x60 mm -  2340 g

910B/C16Q 1 009100933

-  **910B** 6 - 7 - 8 - 9 - 10 - 11 - 12 - 13
14 - 15 - 16 - 17 - 18 - 19
21 - 22 mm
 -  **910/21** 125 mm
 -  **910/22** 250 mm
 -  **910/25**
 -  **910/42**
 -  **910/55Q**
- ≡ 335x145x60 mm -  2340 g

910A/C17

17 hexagon sockets and 9 accessories

38"



910A/C17 1 009100938

-  **910A** 6 - 7 - 8 - 9 - 10 - 11 - 12 - 13
14 - 15 - 16 - 17 - 18 - 19 - 20
21 - 22 mm
 -  **910/15** □ 3/8 - ■ 1/4
 -  **910/16** □ 3/8 - ■ 1/2
 -  **910/21** 125 mm
 -  **910/22** 250 mm
 -  **910/25**
 -  **910/36A**
 -  **910/42**
 -  **910/46**
 -  **910/55**
- ≡ 420x280x60 mm -  4000 g

910.../C29

17 sockets, 12 socket drivers and 5 accessories

38"



910A/C29 1 009100944

-  **910A** 6 - 7 - 8 - 9 - 10 - 11 - 12 - 13
14 - 15 - 16 - 17 - 18 - 19 - 20
21 - 22 mm
 -  **910LP** 1x5,5 - 1,2x6,5 - 1,2x8 mm
 -  **910PH** PH1 - PH2 - PH3
 -  **910PE** 3 - 4 - 5 - 6 - 8 - 10 mm
 -  **910/21** 125 mm
 -  **910/22** 250 mm
 -  **910/25**
 -  **910/42**
 -  **910/55**
- ≡ 420x185x60 mm -  3450 g

910B/C29 1 009100945

-  **910B** 6 - 7 - 8 - 9 - 10 - 11 - 12 - 13
14 - 15 - 16 - 17 - 18 - 19 - 20
21 - 22 mm
 -  **910LP** 1x5,5 - 1,2x6,5 - 1,2x8 mm
 -  **910PH** PH1 - PH2 - PH3
 -  **910PE** 3 - 4 - 5 - 6 - 8 - 10 mm
 -  **910/21** 125 mm
 -  **910/22** 250 mm
 -  **910/25**
 -  **910/42**
 -  **910/55**
- ≡ 420x185x60 mm -  3410 g

910AS/C13...

13 bi-hex sockets and 5 accessories

38"



910AS/C13 1 009100925

-  **910AS** 1/4 - 5/16 - 11/32 - 3/8 - 7/16
1/2 - 9/16 - 19/32 - 5/8 - 11/16
3/4 - 13/16 - 7/8
 -  **910/21** 125 mm
 -  **910/22** 250 mm
 -  **910/42**
 -  **910/25**
 -  **910/55**
- ≡ 335x145x60 mm -  2250 g







910AS/MBM-C18

13 bi-hex sockets and 5 accessories for aeronautical maintenance

38"



910AS/MBM-C18 1 009100926

-  **910AS** 1/4 - 5/16 - 11/32 - 3/8 - 7/16
1/2 - 9/16 - 19/32 - 5/8 - 11/16
3/4 - 13/16 - 7/8
 -  **910/21** 125 mm
 -  **910/22** 250 mm
 -  **910/25**
 -  **910/42**
 -  **910M/55**
- ≡ 335x145x60 mm -  2500 g

 Beta



920A

hexagon hand sockets

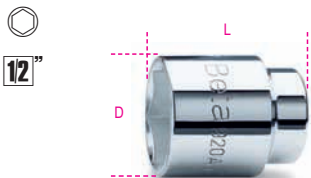

UNI/ISO 2725 DIN 3124

mm	D mm	L mm	
8	12,4	38	10 009200008
9	13,5	38	10 009200009
10	14,9	38	10 009200010
11	16,1	38	10 009200011
12	17,5	38	10 009200012
13	18,7	38	10 009200013
14	20,1	38	10 009200014
15	21,5	38	10 009200015
16	22,7	38	10 009200016
17	24,1	38	10 009200017
18	25,3	39	10 009200018
19	26,6	39	10 009200019
20	27,8	40	10 009200020
21	28,8	40	5 009200021
22	29,9	41	5 009200022
23	30,8	42	5 009200023
24	32,2	43	5 009200024
25	33,2	44	5 009200025
26	34,7	45	5 009200026
27	36,2	46	5 009200027
28	37,2	47	5 009200028
29	38,6	48	5 009200029
30	40,2	48	5 009200030
32	42,3	49	5 009200032



920A/SB13
10-11-12-13-14-15-16
17-18-19-20-21-22 mm



920A/SB8
23-24-25-26-27
28-30-32 mm

920B

bi-hex hand sockets

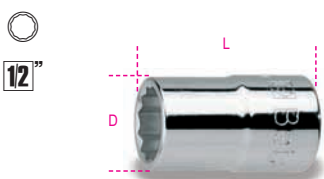

UNI/ISO 2725 DIN 3124

mm	D mm	L mm	
8	12,4	38	10 009200108
9	13,5	38	10 009200109
10	14,9	38	10 009200110

mm	D mm	L mm	
11	16,1	38	10 009200111
12	17,5	38	10 009200112
13	18,7	38	10 009200113
14	20,1	38	10 009200114
15	21,5	38	10 009200115
16	22,7	38	10 009200116
17	24,1	38	10 009200117
18	25,3	39	10 009200118
19	26,6	39	10 009200119
20	27,8	40	5 009200120
21	28,8	40	5 009200121
22	29,9	41	5 009200122
23	30,8	42	5 009200123
24	32,2	43	5 009200124
25	33,2	44	5 009200125
26	34,7	45	5 009200126
27	36,2	46	5 009200127
28	37,2	47	5 009200128
29	38,6	48	5 009200129
30	40,2	48	5 009200130
32	42,3	49	5 009200132



920B/SB13
10-11-12-13-14-15-16
17-18-19-20-21-22 mm



920B/SB8
23-24-25-26-27
28-30-32 mm

920AL

hexagon hand sockets,
long series



UNI/ISO 2725 DIN 3124

mm	D mm	L mm	
10	14,7	77	5 009200626
12	17,8	77	5 009200627
13	19,0	77	5 009200628
14	20,3	77	5 009200629
15	21,5	77	5 009200630
16	22,8	77	5 009200631
17	24,0	77	5 009200632
18	25,0	77	5 009200633
19	26,5	77	5 009200634
21	29,0	77	5 009200635
22	30,0	77	5 009200636
23	31,5	77	5 009200637
24	32,8	77	5 009200638
27	36,5	77	3 009200639
30	40,0	77	3 009200640
32	42,8	77	3 009200641
36	48,0	77	3 009200642



920AL/SB11
10-12-13-14-15-16
17-18-19-21-22 mm

920BL

bi-hex hand sockets, long series



UNI/ISO 2725 DIN 3124

mm	D mm	L mm	
10	14,7	77	5 009200310
12	17,8	77	5 009200312
13	19,0	77	5 009200313
14	20,3	77	5 009200314
15	21,5	77	5 009200315
16	22,8	77	5 009200316
17	24,0	77	5 009200317
18	25,0	77	5 009200318
19	26,5	77	5 009200319
21	29,0	77	5 009200321
22	30,0	77	5 009200322
23	31,5	77	5 009200323
24	32,8	77	5 009200324
27	36,5	77	3 009200327
30	40,0	77	3 009200330
32	42,8	77	3 009200332
36	48,0	77	3 009200336



920BL/SB11
10-12-13-14-15-16-17-18
19-21-22 mm

920A/AS

hexagon hand sockets

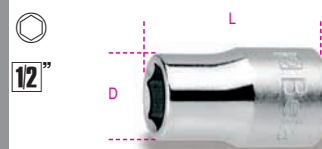

mm	D mm	L mm	
3/8	14,6	37	5 009200270
7/16	16,5	37	5 009200272
1/2	19,0	37	5 009200273
9/16	20,3	37	5 009200274
5/8	22,8	37	5 009200276
11/16	25,0	37	5 009200277
3/4	26,5	38	5 009200279
13/16	29,0	38	5 009200281
7/8	30,0	40	5 009200282
15/16	32,8	42	5 009200284
1	35,0	42	5 009200285
1.1/16	36,5	43	5 009200287
1.1/8	39,0	43	5 009200289
1.1/4	42,8	46	5 009200292



920A-AS/SB11
3/8-7/16-1/2-9/16-5/8
11/16-3/4-13/16-7/8
15/16-1

920AS

bi-hex hand sockets

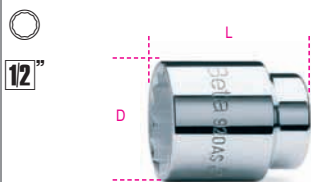

Size	D mm	L mm	Quantity	Part No.
3/8	14,9	38	5	009200201
7/16	16,1	38	5	009200202
1/2	18,7	38	5	009200203
9/16	20,1	38	5	009200204
5/8	22,7	38	5	009200206
19/32	21,5	38	5	009200207
11/16	25,3	39	5	009200208
3/4	26,6	39	5	009200209
25/32	27,8	40	5	009200210
13/16	28,8	40	5	009200211
7/8	29,9	41	5	009200212
15/16	32,2	43	5	009200214
1	34,2	45	5	009200216
1.1/16	36,2	46	5	009200217
1.1/8	38,6	48	5	009200218
1.3/16	40,2	48	5	009200219
1.1/4	42,3	49	5	009200220



Part No.	Quantity
920AS/SB11	1 009200225

3/8-7/16-1/2-9/16-5/8
11/16-3/4-13/16-7/8
15/16-1

920AS/L

bi-hex hand sockets, long series



Size	D mm	L mm	Quantity	Part No.
1/2	19,0	77	2	009200352
9/16	20,3	77	2	009200353
5/8	22,8	77	2	009200355
11/16	25,0	77	2	009200357
3/4	26,5	77	2	009200358
13/16	29,0	77	2	009200360
7/8	30,0	77	2	009200361
15/16	32,8	77	2	009200362
1	35,0	77	2	009200363
1.1/16	36,5	77	2	009200364
1.1/8	37,8	77	2	009200365



Part No.	Quantity
920ASL/SB11	1 009200369

1/2-9/16-5/8-11/16
3/4-13/16-7/8-15/16
1-1.1/8-1.1/16

920FTX

hand sockets for Torx® head screws

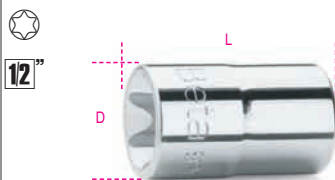

Size	D mm	L mm	Quantity	Part No.
E10	13,2	36	5	009200380
E12	15,0	37	5	009200381
E14	16,3	37	5	009200382
E16	18,8	37	5	009200383
E18	20,4	37	5	009200384
E20	22,9	37	5	009200385
E22	25,0	37	5	009200387
E24	26,5	40	5	009200388



Part No.	Quantity
920FTX/SB6	1 009200390

E10-E12-E14
E16-E18-E20



Part No.	Quantity
920FTX/C8	1 009200391

E10-E12-E14-E16
E18-E20-E22-E24

270X120X45 mm - 1050 g

920FTX/L

hand sockets for Torx® head screws, long series



Size	D mm	Quantity	Part No.
E10	13,2	5	009200400
E12	15,0	5	009200401
E14	16,3	5	009200402
E16	18,8	5	009200403
E18	20,4	5	009200404
E20	22,9	5	009200405



Part No.	Quantity
920FTX/LSB6	1 009200409

E10-E12-E14
E16-E18-E20

920LP

socket drivers for slotted head screws



Size	SxA mm	D mm	Quantity	Part No.
1x5,5	22,5	22,5	5	009200452
1,2x6,5	22,5	22,5	5	009200453
1,2x8	22,5	22,5	5	009200454
1,6x9	22,5	22,5	5	009200456
2x12	22,5	22,5	5	009200458

920PH

socket drivers for cross head Phillips® screws



Size	D mm	Quantity	Part No.
PH 1	22,5	5	009200471
PH 2	22,5	5	009200472
PH 3	22,5	5	009200473
PH 4	22,5	5	009200474

920LH/SB7

socket drivers for cross head Phillips® screws



Part No.	Quantity
920LH/SB7	1 009200478

920LP 1,2x6,5 - 1,2x8
1,6x9 - 2X12 mm
920PH PH2 - PH3 - PH4



920PE

socket drivers for hexagon screws

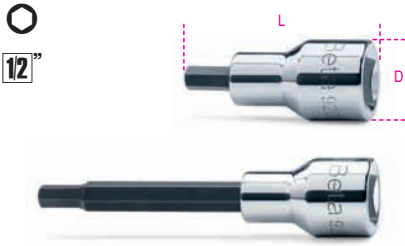

mm	D mm	L mm		
3	22,5	58	5	009200410
4	22,5	58	5	009200412
5	22,5	58	5	009200414
5L	22,5	100	5	009200415
6	22,5	58	5	009200417
6L	22,5	100	5	009200418
7	22,5	58	5	009200420
7L	22,5	100	5	009200421
8	22,5	58	5	009200423
8L	22,5	100	5	009200424
9	22,5	58	5	009200425
9L	22,5	140	5	009200426
10	22,5	58	5	009200428
10L	22,5	140	5	009200429
12	23,0	58	5	009200432
14	23,0	58	5	009200434
17	29,5	60	5	009200437
19	29,5	60	5	009200439



920PE/SB9
4-5-6-8-10 mm
5L-6L-8L-10L mm



920PE/C10
4-5-6-7-8-10
12-14-17-19 mm
270X120X45 mm - 1450 g

920PE/LS4

set of 4 socket drivers item 920PE



6L-7L-8L-10L
1 009200442

920PE/AS

socket drivers for hexagon screws



	D mm	L mm		
1/8	22,5	58	2	009200460
3/16	22,5	58	2	009200461
1/4	22,5	58	2	009200463
1/2	22,5	60	2	009200465
3/4	22,5	60	1	009200468

920BP

ball head socket drivers for hexagon screws



mm	L mm		
5L	100	5	009200490
5XL	240	1	009200495
6L	100	5	009200491
6XL	240	1	009200496
7L	100	5	009200492
8L	100	5	009200493
8XL	240	1	009200497
10L	140	5	009200494



920BP/SB8
5L-6L-7L-8L-10L mm
5XL-6XL-8XL mm

920ME

socket drivers for hexagon screws



mm	D mm		
5	21	5	009200505
6	21	5	009200506
7	21	5	009200507
8	21	5	009200508
10	23	5	009200510
12	24	5	009200512
14	24	5	009200514
17	24	5	009200517



920ME/SB7
5-6-8-10-12-14-17 mm



920ME/C7
5-6-8-10-12-14-17 mm
250X100X35 mm - 1360 g

920TX

socket drivers for Torx® head screws

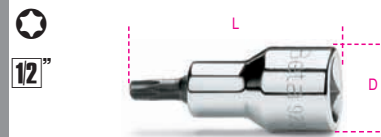

	D mm	L mm		
T20	22,5	58	5	009200520
T25	22,5	58	5	009200521
T27	22,5	58	5	009200522
T30	22,5	58	5	009200523
T40	22,5	58	5	009200524
T40L	22,5	120	3	009200535
T45	22,5	58	5	009200525
T45L	22,5	120	3	009200537
T50	22,5	58	5	009200526
T55	23,0	58	3	009200527
T55L	23,0	140	3	009200539
T60	23,0	58	3	009200528
T70L	23,0	120	3	009200541



920TX/SB9
T20-T25-T27-T30
T40-T45-T50-T55-T60

12"



920TX/C9

T20-T25-T27-T30-T40
T45-T50-T55-T60

270X120X45 mm - 1200 g

1 009200546

920TX/LS4

set of 4 socket drivers item 920TX

12"



40L-45L-55L-70L

1 009200544

920RTX

socket drivers
for Tamper Resistant Torx® head screws

12"



T20

5 009200370

T25

5 009200371

T27

5 009200372

T30

5 009200373

T40

5 009200374

12"



920RTX/SB5

T20-T25-T27-T30-T40

1 009200378

920XZN

socket drivers with XZN® profile

12"



M4

D mm

L mm

5 009200559

M5

D mm

L mm

5 009200560

M6

D mm

L mm

5 009200561

	D mm	L mm		
M6L	22,5	100	3	009200562
M8	22,5	58	5	009200563
M8L	22,5	100	3	009200564
M9	22,5	58	3	009200582
M9L	22,5	100	3	009200583
M10	22,5	58	3	009200565
M10L	22,5	100	3	009200566
M12	22,5	58	3	009200568
M12L	22,5	100	3	009200569
M14	23,0	58	3	009200571
M14L	23,0	100	3	009200572
M16	23,0	58	3	009200573
M18	23,0	58	3	009200574

12"



920XZN/SB7

M4-M5-M6-M8
M10-M12-M14

1 009200579

12"



920XZN/SB12

M5-M6-M8-M10-M12
M14-M16-M6L-M8L
M10L-M12L-M14L

1 009200577

12"



920XZN/LS5

M6L-M8L-M10L
M12L-M14L

1 009200578

920ES

special form socket drivers

12"



UNI 9326

Ø mm	L mm		
7	(6R) 58	5	009200587
7XL	(6R) 240	1	009200607
9	(8R) 58	5	009200589
9XL	(8R) 240	1	009200609
10	(8S) 58	5	009200590
10XL	(8S) 240	1	009200610
11	(10R) 58	5	009200591
11XL	(10R) 240	1	009200611
12L	(10S) 100	3	009200592
12XL	(10S) 240	1	009200612
14L	(12S) 100	3	009200594
14XL	(12S) 240	1	009200614
16L	(14R) 100	3	009200596
16XL	(14R) 240	1	009200616

12"

12"



920ES/SB7

7-9-10-11-12L-14L-16L

1 009200598

920/15

adaptor, 1/2" female
and 3/8" male drives

12"



UNI/ISO 3316 DIN 3123

□	■	L mm		
1/2	3/8	42	5	009200810

Always apply torque loads evenly
and progressively to avoid breakage
and any possible injury.

920/16

adaptor, 1/2" female
and 3/4" male drives

12"



UNI/ISO 3316 DIN 3123

□	■	L mm		
1/2	3/4	46	5	009200814

920/20 - 920/21 - 920/22

1/2" drive extension bars

12"

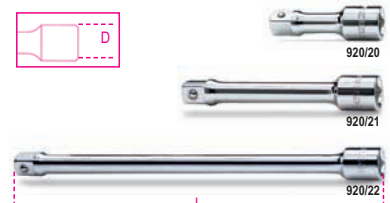

UNI/ISO 3316 DIN 3123

	L mm	D mm		
920/20	75	22	5	009200818
920/21	125	22	5	009200822
920/22	255	22	5	009200826



920AN

1/2" wobble extension bars

12"



920AN/50



920AN/125



920AN/250



920AN/375



	L mm	D mm		
920AN/50	50	22	5	009200833
920AN/125	125	22	5	009200834
920AN/250	250	22	3	009200835
920AN/375	375	22	3	009200836

920/25

1/2" drive universal joint

12"



UNI/ISO 3316 DIN 3123

L mm	D mm		
75	27	5	009200830

920/35A

1/2" drive swivel handle

12"



UNI/ISO 3315 DIN 3122

L mm			
285	3	009200846	

920M/35

1/2" swivel drive with metal handle

12"



UNI/ISO 3315 DIN 3122

L mm			
380	2	009200845	

920M/35L

1/2" swivel drive with metal handle, long series

12"



L

mm

600



1 009200843



Always apply torque loads evenly and progressively to avoid breakage and any possible injury.

920/36A

1/2" drive swivel handle

12"



UNI/ISO 3315 DIN 3122

L

mm

408



2 009200847

920/40

1/2" drive swivel T-handle

12"



L

mm

490



2 009200850

920/42

1/2" drive sliding T handle

12"



UNI/ISO 3315 DIN 3122

L

mm

305



5 009200854

920/44

1/2" drive offset handle

12"



UNI/ISO 3315 DIN 3122

L

mm

230



3 009200858

920/46

1/2" drive with speed brace

12"

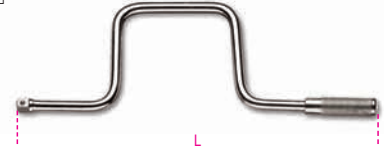

UNI/ISO 3315 DIN 3122

L

mm

385



1 009200862

920/50

1/2" push-through drive ratchet, 72 teeth

72

12"



UNI/ISO 3315 DIN 3122

L

mm

275

D

mm

40

A

mm

42



3 009200871

920/50F

1/2" female square drive ratchet, 72 teeth

72

12"



UNI/ISO 3315 DIN 3122

L

mm

275

D

mm

40

A

mm

27



2 009200889

920/55

1/2" drive reversible ratchet, 72 teeth

72

12"



UNI/ISO 3315 DIN 3122

L

mm

275

D

mm

40

A

mm

43



3 009200882

920/55Q

1/2" drive reversible ratchet, 48 teeth

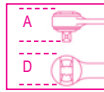

UNI/ISO 3315 DIN 3122

L	D	A		
mm	mm	mm		
275	40	43	3	009200885

920/55X

1/2" drive reversible ratchet, 72 teeth

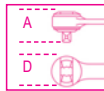

UNI/ISO 3315 DIN 3122

L	D	A		
mm	mm	mm		
200	30	33	3	009200895

920/55LC

1/2" drive reversible ratchet "Locking System", 72 teeth

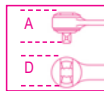

UNI/ISO 3315 DIN 3122

L	D	A		
mm	mm	mm		
275	40	43	2	009200896

920M/55

1/2" drive reversible ratchet with metal handle

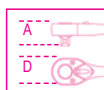

L	D	A		
mm	mm	mm		
253	38	35	1	009200893

920/56A

1/2" drive swivel reversible ratchet, 72 teeth

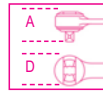

L	D	A		
mm	mm	mm		
315	40	43	1	009200911

920M/56

1/2" drive reversible swivel ratchet with metal handle

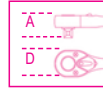

L	D	A		
mm	mm	mm		
330	38	35,7	2	009200894

920.../C11

11 sockets and 2 accessories



920A/C11		
1	009200921	

920A	10 - 12 - 13 - 14 - 15 - 16 17 - 18 - 19 - 21 - 22 mm
920/22	255 mm
920/50	
420x145x60 mm - 2530 g	

920B/C11		
1	009200922	

920B	10 - 12 - 13 - 14 - 15 - 16 17 - 18 - 19 - 21 - 22 mm
920/22	255 mm
920/50	
420x145x60 mm - 2500 g	

920.../C12...

12 sockets and 5 accessories



920A/C12X		
1	009200933	

920A	10 - 11 - 12 - 13 - 14 - 17 - 19 22 - 24 - 27 - 30 - 32 mm
920/21	125 mm
920/22	255 mm
920/25	
920/42	
920/55	
420x185x60 mm - 4180 g	

920A/C12		
1	009200931	

920A	10 - 11 - 12 - 13 - 14 - 17 - 19 22 - 24 - 27 - 30 - 32 mm
920/21	125 mm
920/22	255 mm
920/25	
920/42	
920/50	
420x185x60 mm - 4180 g	

920B/C12X		
1	009200934	

920B	10 - 11 - 12 - 13 - 14 - 17 - 19 22 - 24 - 27 - 30 - 32 mm
920/21	125 mm
920/22	255 mm
920/25	
920/42	
920/55	
420x185x60 mm - 4050 g	

920B/C12		
1	009200932	

920B	10 - 11 - 12 - 13 - 14 - 17 - 19 22 - 24 - 27 - 30 - 32 mm
920/21	125 mm
920/22	255 mm
920/25	
920/42	
920/50	
420x185x60 mm - 4050 g	

920.../C20...

20 sockets and 5 accessories

12"



920A/C20X

1 009200950

 ○ 920A	10 - 11 - 12 - 13 - 14 - 15 - 16 17 - 18 - 19 - 20 - 21 - 22 - 23 24 - 26 - 27 - 28 - 30 - 32 mm
 920/21	125 mm
 920/22	255 mm
 920/25	
 920/42	
 920/55	
☞ 420x185x60 mm - 📐 5100 g	

920A/C20

1 009200948

 ○ 920A	10 - 11 - 12 - 13 - 14 - 15 - 16 17 - 18 - 19 - 20 - 21 - 22 - 23 24 - 26 - 27 - 28 - 30 - 32 mm
 920/21	125 mm
 920/22	255 mm
 920/25	
 920/42	
 920/50	
☞ 420x185x60 mm - 📐 5130 g	

920A/C20Q

1 009200955

 ○ 920A	10 - 11 - 12 - 13 - 14 - 15 - 16 17 - 18 - 19 - 20 - 21 - 22 - 23 24 - 26 - 27 - 28 - 30 - 32 mm
 920/21	125 mm
 920/22	255 mm
 920/25	
 920/42	
 920/55Q	
☞ 420x185x60 mm - 📐 5100 g	

920B/C20

1 009200949

 ○ 920B	10 - 11 - 12 - 13 - 14 - 15 - 16 17 - 18 - 19 - 20 - 21 - 22 - 23 24 - 26 - 27 - 28 - 30 - 32 mm
 920/21	125 mm
 920/22	255 mm
 920/25	
 920/42	
 920/50	
☞ 420x185x60 mm - 📐 5080 g	

920B/C20X

1 009200951

 ○ 920B	10 - 11 - 12 - 13 - 14 - 15 - 16 17 - 18 - 19 - 20 - 21 - 22 - 23 24 - 26 - 27 - 28 - 30 - 32 mm
 920/21	125 mm
 920/22	255 mm
 920/25	
 920/42	
 920/55	
☞ 420x185x60 mm - 📐 5050 g	

920.../C21...

21 sockets and 6 accessories

12"



920A/C21

1 009200952

 ○ 920A	10 - 11 - 12 - 13 - 14 - 15 - 16 17 - 18 - 19 - 20 - 21 - 22 - 23 24 - 25 - 26 - 27 - 28 - 30 - 32 mm
 920/21	125 mm
 920/22	255 mm
 920/25	
 920/42	
 920/46	
 920/50	
☞ 420x280x60 mm - 📐 6510 g	

920A/C21X

1 009200983

 ○ 920A	10 - 11 - 12 - 13 - 14 - 15 - 16 17 - 18 - 19 - 20 - 21 - 22 - 23 24 - 25 - 26 - 27 - 28 - 30 - 32 mm
 920/21	125 mm
 920/22	255 mm
 920/25	
 920/42	
 920/46	
 920/55	
☞ 420x280x60 mm - 📐 6440 g	

920B/C21

1 009200953

 ○ 920B	10 - 11 - 12 - 13 - 14 - 15 - 16 17 - 18 - 19 - 20 - 21 - 22 - 23 24 - 25 - 26 - 27 - 28 - 30 - 32 mm
 920/21	125 mm
 920/22	255 mm
 920/25	
 920/42	
 920/46	
 920/50	
☞ 420x280x60 mm - 📐 6430 g	

920B/C21X

1 009200984

 ○ 920B	10 - 11 - 12 - 13 - 14 - 15 - 16 17 - 18 - 19 - 20 - 21 - 22 - 23 24 - 25 - 26 - 27 - 28 - 30 - 32 mm
 920/21	125 mm
 920/22	255 mm
 920/25	
 920/42	
 920/46	
 920/55	
☞ 420x280x60 mm - 📐 6380 g	

920B/C30Q

30 bi-hex sockets and 5 accessories

12"



920B/C30Q

1 009200975

 ○ 920B	8 - 9 - 10 - 11 - 12 - 13 - 14 15 - 16 - 17 - 18 - 19 - 20 - 21 22 - 23 - 24 - 26 - 27 - 30 mm
 ○ 920BL	12 - 13 - 14 - 17 - 19 - 21 22 - 24 - 27 - 30 mm
 920/21	125 mm
 920/22	255 mm
 920/25	
 920/42	
 920/55Q	
☞ 420x280x60 mm - 📐 7600 g	

Beta



920.../C33

20 sockets, 13 socket drivers and 5 accessories

12"



920A/C33

1 009200985

	920A	10 - 11 - 12 - 13 - 14 - 15 - 16 17 - 18 - 19 - 20 - 21 - 22 - 23 24 - 26 - 27 - 28 - 30 - 32 mm
	920LP	1,2x8 - 1,6x9 - 2x12 mm
	920PH	PH2 - PH3 - PH4
	920PE	4 - 5 - 6 - 8 - 10 - 12 - 14 mm
	920/21	125 mm
	920/22	255 mm
	920/25	
	920/42	
	920/55	

420x280x60 mm - 6720 g

920/C37

37 bi-hex sockets and 5 accessories

12"



920/C37

1 009200988

	920B	10 - 11 - 12 - 13 - 14 - 15 - 16 17 - 18 - 19 - 20 - 21 - 22 - 23 24 - 26 - 27 - 28 - 30 - 32 mm
	920AS	3/8 - 7/16 - 1/2 - 9/16 - 19/32 5/8 - 11/16 - 3/4 - 25/32 - 13/16 7/8 - 15/16 - 1 - 1.1/16 - 1.1/8 1.3/16 - 1.1/4
	920/21	125 mm
	920/22	255 mm
	920/25	
	920/42	
	920/55	

420x280x60 mm - 7500 g

920AS/C15

15 bi-hex sockets and 6 accessories

12"



920AS/C15

1 009200947

	920AS	3/8 - 7/16 - 1/2 - 9/16 - 5/8 - 11/16 3/4 - 13/16 - 7/8 - 15/16 - 1 1.1/16 - 1.1/8 - 1.3/16 - 1.1/4
	920/21	125 mm
	920/22	255 mm
	920/25	
	920/42	
	920/46	
	920/50	

420x280x60 mm - 5900 g

920AS/C17X

17 bi-hex sockets and 5 accessories

12"



920AS/C17X

1 009200942

	920AS	3/8 - 7/16 - 1/2 - 9/16 - 19/32 - 5/8 11/16 - 3/4 - 25/32 - 13/16 - 7/8 15/16 - 1 - 1.1/16 - 1.1/8 - 1.3/16 - 1.1/4
	920/21	125 mm
	920/22	255 mm
	920/25	
	920/42	
	920/55	

420x185x60 mm - 4800 g

920B/C33

1 009200986

	920B	10 - 11 - 12 - 13 - 14 - 15 - 16 17 - 18 - 19 - 20 - 21 - 22 - 23 24 - 26 - 27 - 28 - 30 - 32 mm
	920LP	1,2x8 - 1,6x9 - 2x12 mm
	920PH	PH2 - PH3 - PH4
	920PE	4 - 5 - 6 - 8 - 10 - 12 - 14 mm
	920/21	125 mm
	920/22	255 mm
	920/25	
	920/42	
	920/55	

420x280x60 mm - 6650 g

920AS/C10

10 bi-hex sockets and 2 accessories

12"



920AS/C10

1 009200919

	920AS	3/8 - 7/16 - 1/2 - 9/16 - 5/8 11/16 - 3/4 - 13/16 - 7/8 - 15/16
	920/22	255 mm
	920/50	

335x145x60 mm - 2600 g

Beta
SHOP
in shop

920AS/MBM-C21

16 bi-hex sockets and 5 accessories for aeronautical maintenance

12"



920AS/MBM-C21

1 009200944

	920AS	3/8 - 7/16 - 1/2 - 9/16 19/32 - 5/8 - 11/16 - 3/4 25/32 - 13/16 - 7/8 - 15/16 1 - 1.1/16 - 1.3/16 - 1.1/4
	920M/55	
	920/21	125 mm
	920/22	255 mm
	920/25	
	920/42	
		420x185x60 mm - 5000 g

920TX/C17

6 bits, 6 sockets, 5 socket drivers and 4 accessories for Torx® head screws

12"



920TX/C17

1 009200989

	861TX	T8 - T10 - T15 - T20 - T25 - T27
	897	
	920TX	T27 - T30 - T40 - T45 - T50
	920FTX	E10 - E12 - E14 - E16 - E18 - E20
	920/20	75 mm
	920/22	255 mm
	920/55	
		420x185x60 mm - 2900 g

928A

hexagon hand sockets

3/4"



mm	D mm	L mm		
19	29,2	50	5	009280019
22	31,3	53	5	009280022
23	33,3	53	5	009280023
24	34,5	53	5	009280024
26	36,8	55	5	009280026
27	38,0	56	5	009280027
28	39,0	57	5	009280028
29	40,2	58	5	009280029
30	41,5	58	5	009280030
32	44,3	60	5	009280032
33	45,8	60	3	009280033
34	46,8	60	3	009280034
35	48,1	62	3	009280035
36	49,5	64	3	009280036
38	52,0	68	3	009280038
41	56,0	71	3	009280041
46	62,3	75	3	009280046
50	67,4	80	3	009280050
55	73,7	84	1	009280055
60	80,0	87	1	009280060

928B

bi-hex hand sockets

3/4"



mm	D mm	L mm		
19	29,2	50	5	009280119
22	31,3	53	5	009280122
23	33,3	53	5	009280123
24	34,5	53	5	009280124
26	36,8	55	5	009280126
27	38,0	56	5	009280127
28	39,0	57	5	009280128
29	40,2	58	5	009280129
30	41,5	58	5	009280130
32	44,3	60	5	009280132
33	45,8	60	3	009280133
34	46,8	60	3	009280134
35	48,1	62	3	009280135
36	49,5	64	3	009280136
38	52,0	68	3	009280138
41	56,0	71	3	009280141
46	62,3	75	3	009280146
50	67,4	80	3	009280150
55	73,7	84	1	009280155
60	80,0	87	1	009280160

928AS

hexagon hand sockets

3/4"



mm	D mm	L mm		
7/8	32,0	53	1	009280202
15/16	34,5	53	1	009280203
1	36,2	55	1	009280204
1.1/16	38,0	56	1	009280205
1.1/8	40,2	58	1	009280206
1.1/4	44,2	60	1	009280208
1.5/16	45,8	60	1	009280209
1.3/8	48,1	62	1	009280210
1.7/16	49,5	64	1	009280211
1.1/2	52,0	68	1	009280212
1.5/8	56,0	71	1	009280214
1.11/16	58,8	74	1	009280215
1.13/16	62,3	75	1	009280217
1.7/8	65,0	78	1	009280218
2	68,3	80	1	009280219
2.1/16	71,5	83	1	009280220

928ME

socket drivers for hexagon screws

3/4"



mm	L mm		
14	75	2	009280514
17	75	2	009280517
19	75	2	009280519
22	75	2	009280522

928/15

adaptor, 3/4" female and 1/2" male drives

3/4"



UNI/ISO 3316 DIN 3123

	L mm		
3/4	51,5	5	009280801



Always apply torque loads evenly and progressively to avoid breakage and any possible injury.

928/16

adaptor, 3/4" female and 1" male drives



UNI/ISO 3316 DIN 3123

□	■	L mm	
3/4	1"	65	5 009280807

928/21 - 928/22

3/4" drive extension bars



	L mm	D mm	
928/21	200	34	3 009280815
928/22	380	34	3 009280825

928/25

3/4" drive universal joint



UNI/ISO 3316 DIN 3123

L mm	D mm	
108	40	1 009280830

928/36A

3/4" drive swivel handle



L mm	
545	1 009280844

928/42

3/4" drive slide T-handle

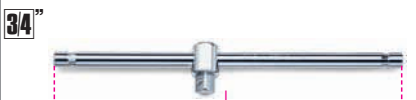

L mm	
450	3 009280850

928/55

3/4" drive reversible ratchet, 72 teeth



L mm	D mm	A mm	
510	58	59	2 009280862

928.../C9SN

9 hexagon hand sockets and 5 accessories



928A/C9SN 1 009280962

	928A	22-24-27-30-32-36 41-46-50 mm
	928/21	200 mm
	928/22	380 mm
	928/25	
	928/42	
	928/55	

530x220x80 mm - 12,0 kg

928B/C9SN 1 009280966

	928B	22-24-27-30-32-36 41-46-50 mm
	928/21	200 mm
	928/22	380 mm
	928/25	
	928/42	
	928/55	

530x220x80 mm - 12,2 kg

928.../C11

11 sockets and 7 accessories



928A/C11 1 009280954

	928A	22-24-27-30-32-36 41-46-50-55-60 mm
	928/15	□ 3/4 - ■ 1/2
	928/16	□ 3/4 - ■ 1"
	928/21	200 mm
	928/22	380 mm
	928/36A	
	928/42	
	928/55	

530x220x95 mm - 16,7 kg

928B/C11 1 009280958

	928B	22-24-27-30-32-36 41-46-50-55-60 mm
	928/15	□ 3/4 - ■ 1/2
	928/16	□ 3/4 - ■ 1"
	928/21	200 mm
	928/22	380 mm
	928/36A	
	928/42	
	928/55	

530x220x95 mm - 16,5 kg

928AS/C8SN

8 hexagon hand sockets and 5 accessories



928AS/C8SN 1 009280967

	928AS	7/8-15/16-1.1/8-1.5/16 1.1/2-1.11/16-1.7/8-2.1/16
	928/21	200 mm
	928/22	380 mm
	928/25	
	928/42	
	928/55	

530x220x80 mm - 12,5 kg

Beta



929

hexagon hand sockets

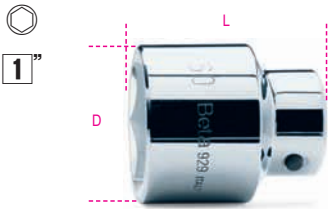

UNI/ISO 2725 DIN 3124

mm	D mm	L mm		
36	49,5	65	1	009290036
41	56,0	70	1	009290041
46	62,0	75	1	009290046
50	67,5	80	1	009290050
55	74,0	85	1	009290055
60	80,0	90	1	009290060
65	86,0	95	1	009290065
70	92,0	100	1	009290070
75	99,0	110	1	009290075
80	106,0	120	1	009290080

929/15

adaptor, 1" female and 3/4" male drives

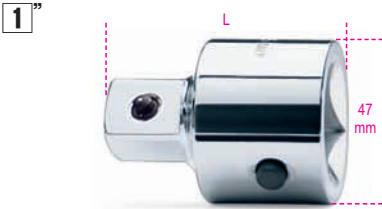

UNI/ISO 3316 DIN 3123

	L mm		
1"	3/4	65	2 009290801



Always apply torque loads evenly and progressively to avoid breakage and any possible injury.

929/21 - 929/22

1" drive extension bars



UNI/ISO 3316 DIN 3123

	L mm	D mm		
929/21	200	47	1	009290815
929/22	400	47	1	009290825

929/42

1" drive slide T-handle



UNI/ISO 3315 DIN 3122

L mm		
535	1	009290850

929/55

1" drive slide T-handle



UNI/ISO 3315 DIN 3122

L mm	D mm	A mm		
770	62	63	1	009290860

929/C8

8 hexagon sockets and 5 accessories



929/C8

1 009290925

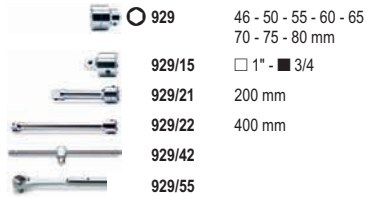

560x290x12 mm - 29 kg

900/R55



900/R55
x 900/55

1 009000871

900M/R55



900M/R55
x 900M/55

1 009000888

900M/R56



900M/R56
x 900M/56

1 009000889

910/R55



910/R55
x 606/6-606/10-612
666/6-666/10-910/55
599DGT/6

1 009100879

910M/R55



910M/R55
x 910M/55-910M/56

1 009100888

910/R55Q



910/R55Q
x 910/55Q

1 009100877

920/R50



920/R50
x 614/50-667/20-667/30
920/50

1 009200866

920/R55



920/R55
x 606/20-606/30-666/20-666/30
920/55-920/56A- 599DGT/20-599DGT/30

1 009200879

920M/R55



920M/R55
x 920M/55-920M/56-

1 009200888

920/R55Q



920/R55Q
x 920/55Q

1 009200877

920/R55X

12"



920/R55X
x 606/10X-612X
666/10X-920/55X-599DGT/10X

920/R55LC

12"



920/R55LC
x 920/55LC "Locking System"

928/R55

3/4"



928/R55
x 928/55

928/R55X

3/4"



928/R55X
x 614X

929/R55

1"



929/R55
x 929/55

930

double ended bi-hex tubular socket wrenches, heavy series



UNI 6745

mm	L mm		
6x7	100	5	009300006
8x9	108	5	009300010
10x11	116	5	009300014
12x13	124	5	009300018
14x15	132	5	009300023
16x17	140	5	009300027
18x19	148	5	009300032
20x22	156	3	009300036
21x23	163	3	009300040
24x26	173	3	009300044
25x28	182	3	009300048
27x29	191	3	009300052
30x32	200	3	009300056



930/S8 1 009300081

6x7-8x9-10x11
12x13-14x15-16x17
18x19-20x22 mm

930/S12 1 009300082

6x7-8x9-10x11-12x13
14x15-16x17-18x19
20x22-21x23-24x26
25x28-30x32 mm

930/S13 1 009300083

6x7-8x9-10x11-12x13
14x15-16x17-18x19
20x22-21x23-24x26
25x28-27x29-30x32 mm



930/SP13 1 009300084

6x7-8x9-10x11-12x13
14x15-16x17-18x19
20x22-21x23-24x26
25x28-27x29-30x32 mm

930/SPV 1 009300095



930/C13 1 009300098

6x7-8x9-10x11-12x13
14x15-16x17-18x19
20x22-21x23-24x26
25x28-27x29-30x32 mm

932

double ended hexagon / bi-hex offset socket wrenches, bright chrome-plated

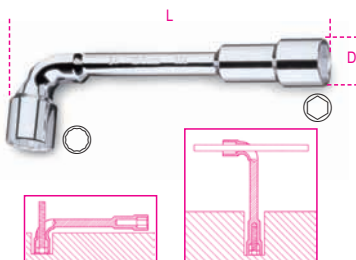

NF E 74.303

mm	D mm	L mm		
6x6	11,0	110	5	009320006
7x7	12,0	114	5	009320007
8x8	13,0	119	5	009320008

mm	D mm	L mm		
9x9	14,5	125	5	009320009
10x10	16,0	131	5	009320010
11x11	17,0	137	5	009320011
12x12	18,0	144	5	009320012
13x13	19,0	152	5	009320013
14x14	21,0	160	5	009320014
15x15	22,5	174	5	009320015
16x16	24,0	185	5	009320016
17x17	25,0	197	5	009320017
18x18	26,5	211	5	009320018
19x19	28,0	218	5	009320019
20x20	30,0	222	5	009320020
21x21	30,5	231	5	009320021
22x22	32,0	247	3	009320022
23x23	33,5	255	3	009320023
24x24	34,5	266	3	009320024
25x25	36,0	278	3	009320025
26x26	37,0	289	3	009320026
27x27	38,5	299	3	009320027
28x28	39,0	310	3	009320028
30x30	42,0	332	3	009320030
32x32	45,0	353	3	009320032



932/S11 1 009320080

6-7-8-10-11-12
13-14-17-19-22 mm

932/S17 1 009320081

6-7-8-9-10-11-12
13-14-15-16-17
18-19-20-21-22 mm

932/S25 1 009320082

6-7-8-9-10-11-12-13
14-15-16-17-18-19
20-21-22-23-24-25
26-27-28-30-32 mm

933

double ended offset hexagon socket wrenches, bright chrome-plated

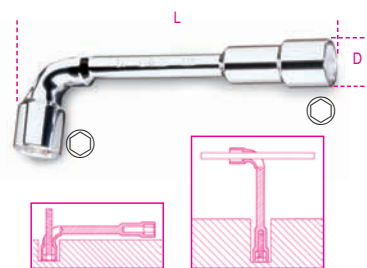

NF E 74.303

mm	D mm	L mm		
6x6	11,0	110	5	009330006
7x7	12,0	114	5	009330007
8x8	13,0	119	5	009330008
9x9	14,5	125	5	009330009
10x10	16,0	131	5	009330010
11x11	17,0	137	5	009330011
12x12	18,0	144	5	009330012
13x13	19,0	152	5	009330013
14x14	21,0	160	5	009330014
15x15	22,5	174	5	009330015
16x16	24,0	185	5	009330016
17x17	25,0	197	5	009330017
18x18	26,5	211	5	009330018
19x19	28,0	218	5	009330019

mm	D mm	L mm		
20x20	30,0	222	5	009330020
21x21	30,5	231	5	009330021
22x22	32,0	247	3	009330022
23x23	33,5	255	3	009330023
24x24	34,5	266	3	009330024
25x25	36,0	278	3	009330025
26x26	37,0	289	3	009330026
27x27	38,5	299	3	009330027
28x28	39,0	310	3	009330028
30x30	42,0	332	3	009330030
32x32	45,0	353	3	009330032



933/S11 6-7-8-10-11-12 13-14-17-19-22 mm	1	009330080
933/S17 6-7-8-9-10-11-12 13-14-15-16-17 18-19-20-21-22 mm	1	009330081
933/S25 6-7-8-9-10-11-12-13 14-15-16-17-18-19 20-21-22-23-24-25 26-27-28-30-32 mm	1	009330082

935

double ended hexagon tubular socket wrenches, light series



UNI 6746 DIN 896

mm	L mm		
6x7	100	5	009350105
8x9	110	5	009350111
10x11	120	5	009350115
12x13	130	5	009350117
14x15	140	5	009350126
16x17	150	5	009350128
18x19	160	5	009350131
20x22	170	3	009350138
21x23	180	3	009350141
24x26	190	3	009350144
25x28	200	3	009350150
27x29	210	3	009350153
30x32	220	3	009350156

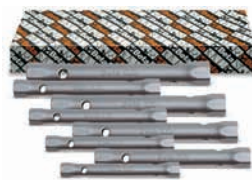

935/S8 6x7-8x9-10x11 12x13-14x15-16x17 18x19-20x22 mm	1	009350181
935/S12 6x7-8x9-10x11 12x13-14x15-16x17 18x19-20x22-21x23 24x26-25x28-30x32 mm	1	009350182
935/S13 6x7-8x9-10x11 12x13-14x15-16x17 18x19-20x22-21x23 24x26-25x28-27x29 30x32 mm	1	009350183

937

double ended hexagon / bi-hex socket wrenches, chrome-plated

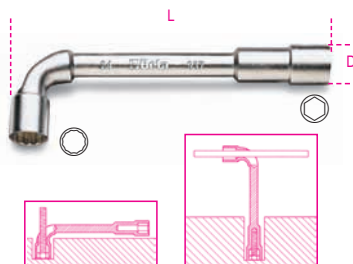

mm	D mm	L mm		
6x6	11,0	110	5	009370006
7x7	12,0	114	5	009370007
8x8	13,0	119	5	009370008
9x9	14,5	125	5	009370009
10x10	16,0	131	5	009370010
11x11	17,0	137	5	009370011
12x12	18,0	144	5	009370012
13x13	19,0	152	5	009370013
14x14	21,0	160	5	009370014
15x15	22,5	174	5	009370015
16x16	24,0	185	5	009370016
17x17	25,0	197	5	009370017
18x18	26,5	211	5	009370018
19x19	28,0	218	5	009370019
20x20	30,0	222	5	009370020
21x21	30,5	231	3	009370021
22x22	32,0	247	3	009370022
23x23	33,5	255	3	009370023
24x24	34,5	266	3	009370024
25x25	36,0	278	3	009370025
26x26	37,0	289	3	009370026
27x27	38,5	299	3	009370027
28x28	39,0	310	3	009370028
30x30	42,0	332	3	009370030
32x32	45,0	353	3	009370032



937/S11 6-7-8-10-11-12 13-14-17-19-22 mm	1	009370080
937/S17 6-7-8-9-10-11-12 13-14-15-16-17 18-19-20-21-22 mm	1	009370081

940

tommy bars for tubular wrenches items 930 and 935



	mm	L mm		
940/1	6+13	100	5	009400001
940/2	14+22	170	5	009400002
940/3	21+32	290	5	009400003

942BX

hi-torque hexagon nut spinners with bi-material handles short series



UNI 6750

mm	L mm	L1 mm		
4	190	70	5	009420003
5	190	70	5	009420004
5,5	190	70	5	009420005
6	190	70	5	009420006
7	190	70	5	009420007
8	202	70	5	009420008
9	202	70	5	009420009
10	202	70	5	009420010
11	202	70	5	009420011
12	202	70	5	009420012
13	202	70	5	009420013
14	202	70	5	009420014



942BX/S12 4-5-5,5-6-7-8-9 10-11-12-13-14 mm	1	009420030
--	---	-----------

Beta



943BX

hi-torque hexagon nut spinners
with bi-material handles
long series



UNI 6750

mm	L mm	L1 mm		
4	270	150	5	009430003
5	270	150	5	009430004
5,5	270	150	5	009430005
6	270	150	5	009430006
7	270	150	5	009430007
8	282	150	5	009430008
9	282	150	5	009430009
10	282	150	5	009430010
11	282	150	5	009430011
12	282	150	5	009430012
13	282	150	5	009430013
14	282	150	5	009430014



943BX/S12

4-5-5,5-6-7-8-9
10-11-12-13-14 mm

1 009430030



943BX/D6

5-6-7-8-10-13 mm

1 009430026

943FL

flexible hexagon nut spinners
with handles



mm	L mm	L1 mm		
5	265	150	5	009430304
5,5	265	150	5	009430305
6	265	150	5	009430306
7	265	150	5	009430307
8	265	150	5	009430308
10	290	175	5	009430310



943FL/S6

5-5,5-6-7-8-10 mm

1 009430320

950

T-handle hexagon socket wrenches

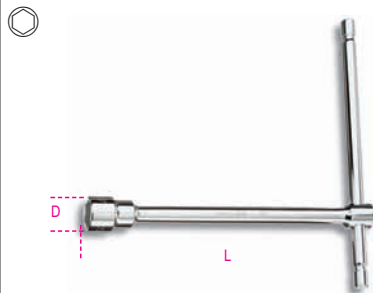

UNI 6742 DIN 3112

mm	L mm	D mm		
6	210	10,1	5	009500006
7	212	11,2	5	009500007
8	220	12,4	5	009500008
9	223	13,5	5	009500009
10	230	14,9	5	009500010
11	233	16,1	5	009500011
12	240	17,5	5	009500012
13	244	19,7	5	009500013
14	250	20,1	3	009500014
15	254	21,5	3	009500015
16	260	22,7	3	009500016
17	264	24,1	3	009500017
19	274	26,6	3	009500019
22	290	29,9	3	009500022
24	300	32,2	3	009500024
27	315	36,2	3	009500027



950/S9

7-8-10-11-12
13-14-17-19 mm

1 009500079

950/S14

6-7-8-9-10-11-12-13
14-15-16-17-19-22 mm

1 009500082

951

T-handle wrenches with three hexagon
male ends

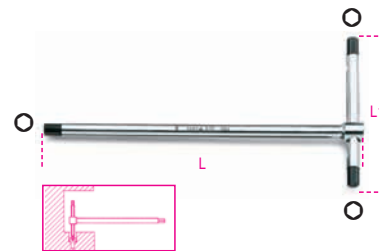

mm	L mm	L1 mm		
2	125	63	5	009510521
2,5	150	63	5	009510525
3	150	63	5	009510530
3,5	175	76	5	009510535
4	175	76	5	009510540
4,5	195	87	5	009510545
5	195	87	5	009510550
6	215	99	5	009510560
7	230	109	5	009510570
8	250	122	5	009510580
9	265	132	5	009510590
10	280	142	5	009510610
12	305	160	3	009510620
14	330	178	3	009510640

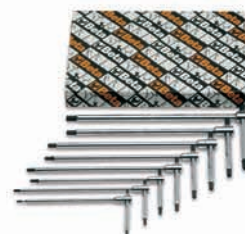

951/S8

2-2,5-3-3,5-4-4,5-5-6 mm

1 009510693

951/S14

2-2,5-3-3,5-4-4,5
5-6-7-8-9-10-12-14 mm

1 009510695



951/SP6

3-4-5-6-8-10 mm

1 009510696

951/SPV

1 009510697

951AS

T-handle wrenches with three hexagon male ends

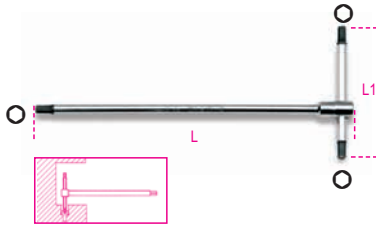

	L mm	L1 mm	
3/32	125	63	2 009510750
7/64	150	63	2 009510751
1/8	150	63	2 009510752
9/64	175	76	2 009510753
5/32	175	76	5 009510754
3/16	195	86	5 009510755
7/32	215	99	5 009510757
1/4	230	109	5 009510758
5/16	250	122	5 009510759
3/8	280	142	5 009510760



951AS/S6		1 009510770
5/32-3/16-7/32		
1/4-5/16-3/8		

951TX

T-handle wrenches with three male ends for Torx® head screws



	L mm	L1 mm	
T8	125	63	5 009510808
T9	125	63	5 009510809
T10	150	63	5 009510810
T15	150	63	5 009510815
T20	175	76	5 009510820
T25	175	76	5 009510825
T27	195	87	5 009510827
T30	195	87	5 009510830
T40	215	99	5 009510840
T45	230	109	5 009510845
T50	250	122	5 009510850

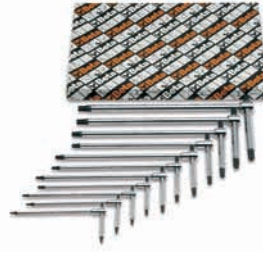

951TX/S11		1 009510860
T8-T9-T10-T15-T20-T25		
T27-T30-T40-T45-T50		

952

T-handle wrenches with swivelling hexagon sockets

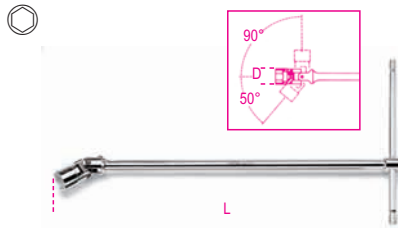

UNI 6743

mm	D mm	L mm	
6	9,5	395	5 009520006
7	10,7	395	5 009520007
8	12,1	395	5 009520008
9	13,2	395	5 009520009
10	14,6	400	5 009520010
11	15,8	400	5 009520011
12	17,0	400	5 009520012
13	18,7	432	5 009520013
14	19,7	432	5 009520014
15	20,9	450	3 009520015
16	22,0	450	3 009520016
17	23,4	450	3 009520017
18	24,7	450	3 009520018
19	26,0	500	3 009520019
20	27,4	500	3 009520020
21	28,5	500	3 009520021
22	29,7	500	3 009520022
24	32,4	500	3 009520024



952/S7		1 009520074
8-10-11-13-14-17-19 mm		
952/S18		1 009520083
6-7-8-9-10-11-12		
13-14-15-16-17		
18-19-20-21-22-24 mm		

952AS

T-handle wrenches with swivelling hexagon sockets

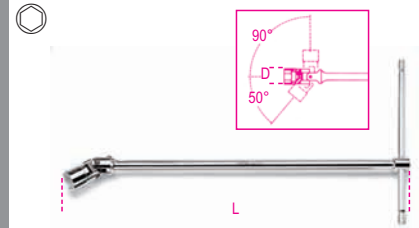

mm	D mm	L mm	
1/4	10,7	395	2 009520256
5/16	12,1	395	2 009520258
3/8	14,6	400	2 009520260
7/16	17,0	400	2 009520261
1/2	18,7	432	2 009520263
9/16	20,9	450	2 009520264
5/8	22,0	450	2 009520266
11/16	24,7	450	2 009520267
3/4	27,4	500	2 009520269
13/16	28,0	500	2 009520271
7/8	32,4	500	2 009520272

952L

T-handle wrenches with swivelling hexagon sockets, long series

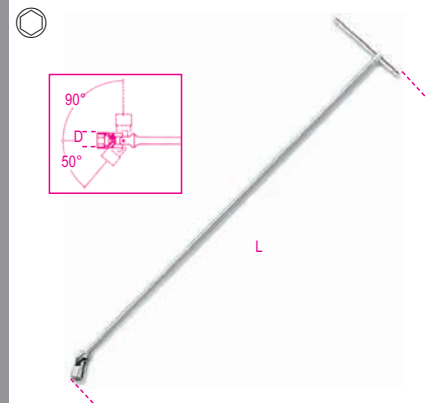

mm	D mm	L mm	
10	14,6	930	1 009520410
12	17,0	930	1 009520412
13	18,7	1100	1 009520413
14	19,7	1100	1 009520414
15	20,9	1100	1 009520415
16	22,0	1100	1 009520416
17	23,4	1100	1 009520417
18	24,7	1100	1 009520418
19	26,0	1100	1 009520419
22	29,7	1100	1 009520422

Beta



952FTX

T-handle wrenches with swivelling socket, for Torx® head screws

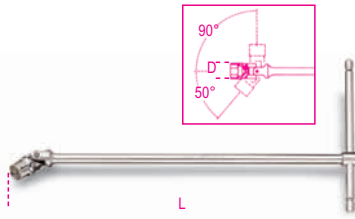

	D mm	L mm		
E6	8	392	2	009520106
E7	9	392	2	009520107
E8	10	395	2	009520108
E10	13	400	2	009520110
E12	15	440	2	009520112
E14	17	490	2	009520114
E16	19	490	2	009520116
E18	21	490	2	009520118
E20	23	490	2	009520120



952FTX/S9
E6-E7-E8-E10-E12
E14-E16-E18-E20
1 009520141

953

T-handle wrenches with swivelling hexagon male ends

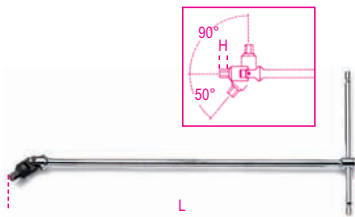

UNI 6754

mm	H mm	L mm		
3	5	395	5	009530130
3,5	6	395	5	009530135
4	6	395	5	009530140
4,5	7	395	5	009530145
5	7	395	5	009530150
6	9	400	5	009530160
7	10	425	5	009530170
8	11	425	5	009530180
10	13	440	5	009530200

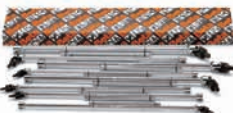

953/S9
3-3,5-4-4,5
5-6-7-8-10 mm
1 009530301

953TX

T-handle wrenches with swivelling end for Torx® head screws

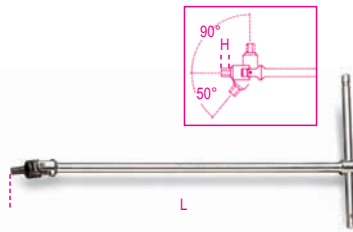

	H mm	L mm		
T20	11	396	2	009530020
T25	11	396	2	009530025
T27	11	396	2	009530027
T30	13	400	2	009530030
T40	13	400	2	009530040
T45	13	426	2	009530045
T50	14	442	2	009530050
T55	14	442	2	009530055



953TX/S8
T20-T25-T27-T30
T40-T45-T50-T55
1 009530060

955

tubular spark-plug wrench
chrome-plated, hexagon end

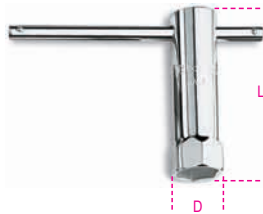

mm	D mm	L mm		
16 (5/8)	21	86	3	009550016
20,8 (13/16)	29	86	5	009550021

956C

1/2" square drive spark plug sockets
chrome-plated, hexagon ends



ISO 11168

mm	D mm	L mm		
14 (9/16)	18,8	70	5	009560008
16 (5/8)	21,4	70	5	009560010
17,8 (11/16)	23,6	70	5	009560011
20,8 (13/16)	27,0	70	5	009560012

956E

3/8" square drive spark plug sockets
chrome-plated, hexagon ends



ISO 11168

mm	D mm	L mm		
14 (9/16)	18,8	70	5	009560018
16 (5/8)	21,4	70	5	009560020
17,8 (11/16)	23,6	70	5	009560021
20,8 (13/16)	27,0	70	5	009560022

956L

1/2" square drive spark plug sockets,
bi-hex ends, long series



mm	D mm	L mm		
14 (9/16)	20,2	250	2	009560214
16 (5/8)	24	250	2	009560216
17,8 (11/16)	24	250	2	009560217
20,8 (13/16)	28,5	250	2	009560221

957

T-handle spark plug wrenches
with swivelling sockets

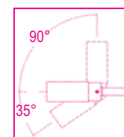

ISO 11168

mm	D mm	L mm		
16 (5/8)	21,4	275	3	009570000
20,8 (13/16)	27,0	275	3	009570001

959

T-handle spark plug wrenches with swivelling sockets, standard series

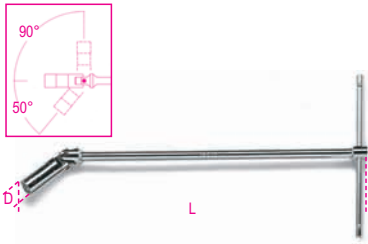

ISO 11168

mm	D mm	L mm		
14 (9/16)	18,8	483	3	009590009
16 (5/8)	21,4	483	3	009590010
20,8 (13/16)	27,0	527	3	009590011

959R

rubber inset and spare spring for items 956C - 956E - 957 - 959

959R/14	3	009590223
956C/14-956E/14		
959R/16	3	009590224
956C/16-956E/16		
957/16-959/16		
959R/17,8	3	009590225
956C/17,8-956E/17,8		
959R/20,8	3	009590226
956C/20,8-956E/20,8		
957/20,8-959/20,8-959L		

960

1/2" square drive socket for Diesel engine injectors

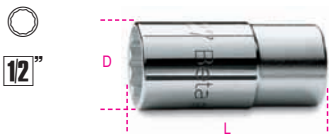

mm	D mm	L mm		
27	36,5	77	5	009600027

960A

1/2" square drive socket for Diesel engine injectors

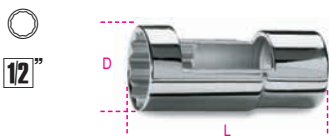

mm	D mm	L mm		
27	36,5	77	3	009600017

960S

1/2" square drive socket for Diesel engine injectors

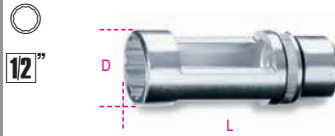

mm	D mm	L mm		
22	31	84	3	009600080

960SN

Diesel engine glow plug wrenches



mm	D mm	□		
8	12,0	1/4	2	009600834
9	13,3	1/4	2	009600835
10	14,5	3/8	2	009600836
11	15,8	3/8	2	009600837
12	17,0	3/8	2	009600838

960SL

sockets for Lambda probes with 1/2" female square drives

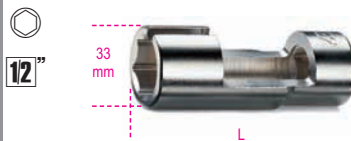

960SL85	3	009600085
○ 22xL= 85 mm		
960SL110	3	009600110
○ 22xL= 110 mm		

960E

open-end socket for nozzle holder ring nuts



●1 mm	●2 mm		
32	22	1	009600145

960F

socket for nozzle holder ring nuts



●1 mm	●2 mm		
32	22	1	009600147

960G

socket for Diesel engine injectors of Mercedes-Benz trucks



Ø mm	Ø1 mm		
27	22	3	009600150

960PMC

Diesel injector test and calibrating hand pump



Bar max. 400	1	009600200
--------------	---	-----------

960AVL

vapour extractor



Bar max. 6	1	009600210
------------	---	-----------

960I

Bosh - Fiat common rail diesel electrical injector puller

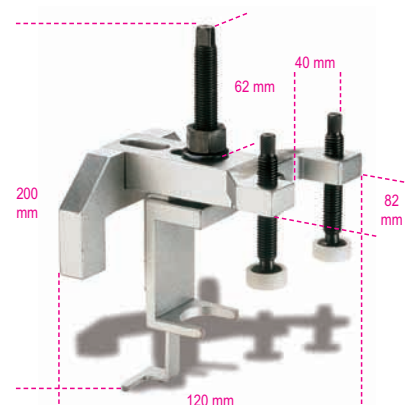

960I	1	009600220
------	---	-----------

960AVE

device for testing common rail diesel electrical injectors



960AVE

1 009600245

960K/AVE2

kit of adaptors for item 960AVE2
(included in item 960AVE)



960K/AVE2

1 009600249

960CMB

instrument for controlling compression on petrol engines



Bar
4÷17

1 009600250

440x370x100 mm - 2200 g

960CMD

instrument for controlling compression on Diesel engines



Bar
8÷40

1 009600270

440x370x100 mm - 2400 g

960KIT/1

3 dummy injectors and 1 dummy spark plug
for item 960CMD



960KIT/1

1 009600600

240x210x45 mm - 710 g

960P

pressure/depressure tester
with accessories and adaptors



960P

1 009600777

350x320x95 mm - 1,9 kg

960TP

digital pressure tester

with wireless module for Beta printer 1498ST/W

CE



Specifications:

- bar: 0-80
- Resolution: 0.1 bar
- Storage of maximum pressure value
- Backlit LCD display
- Software in 6 languages (I, EN, F, ES, PL, NL)
- Environmental pressure adjustment
- Sensor accuracy: +/- 1%
- Sensor can be removed and replaced

960TP

1 009600300

280x240x77 mm - 800 g

960AD/TP

set of 39 adaptors for item 960TP
in plastic case



960AD/TP

1 009600310

450x315x56 mm - 1,5 kg

960CB/TP

set of petrol compression adaptors for item
960 TP



960CB/TP

1 009600311

960CD/TP

set of diesel compression adaptors for item 960 TP



960CD/TP

1 009600312

960PBC/TP

set of petrol pressure and low-pressure common rail system adaptors for item 960 TP



960PBC/TP

1 009600313

960PO/TP

set of oil pressure adaptors for item 960 TP



960PO/TP

1 009600314



960TAP

digital common rail high pressure tester



CE

SPECIFICATIONS:

Measuring range: 0-2000 bar / 0-29000 psi
Resolution: 1 bar
Storage of maximum pressure value
Display: Graphic LCD 64x128 pixels, backlit
Environmental pressure adjustment
Sensor accuracy: +/- 1%
Wireless data transmission to PC
Automatic engine start from tester
Overpressure limit: 3000 bar
Software in 6 languages: I-EN-F-ES-PL-NL

960TAP

1 009600350

960W

wireless receiver for PC (960TP-960TAP)



CE

TECHNICAL DATA

Connection: USB 1.0 and 2.0
Reception frequency: 868 MHz
Power supply: USB-supplied power
Software: CD-ROM

960W

1 009600400

962

tyre levers



L mm	A mm	
300	21	5 009620003
400	25	5 009620004
500	27	3 009620005
600	27	3 009620006

963

pry bar with pointed and flat bent ends



L mm	A mm	
400	23	5 009630001

964

pry bar with pointed and leverage ends



L mm	A mm	
400	46	5 009640001

965

pry bars with flat curved ends



L mm	A mm	L1 mm	
300	16	115	2 009650013
450	20	138	2 009650014
600	20	138	2 009650016



965/S3

1 009650019

970

hub nut locking sockets



mm	
36	1 009700001

970A

hub nut locking sockets



mm	
35	1 009700003

970B

socket for locking Fiat Daily hub nuts

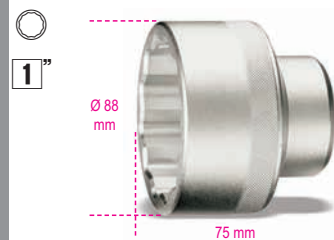

mm	
65	1 009700010

970C

octagonal impact sockets for locking hub nuts



mm	□ - ○		
80	41 mm	1	009700808
95	3/4	1	009700815
100	3/4	1	009700820
109	41 mm	1	009700829
115	3/4	1	009700835
120	41 mm	1	009700840

9700T

oval impact sockets for locking trailer hub nuts



L mm	L1 mm	□ - ○		
65	61	3/4	1	009700165
80	73	3/4	1	009700180
96	90	3/4	1	009700196
111	104	41 mm	1	009700211

978 - 979 - 980

four-way hexagon wheel nut wrenches

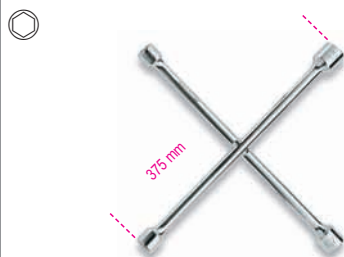

UNI/ISO 6788 DIN 3119

978	2	009780001
17x19x21x22 mm		
979	2	009790001
17x19x22x1/2 mm		
980	2	009800003
19x22x13/16x1/2 mm		

982

four-way hexagon wheel nut wrench

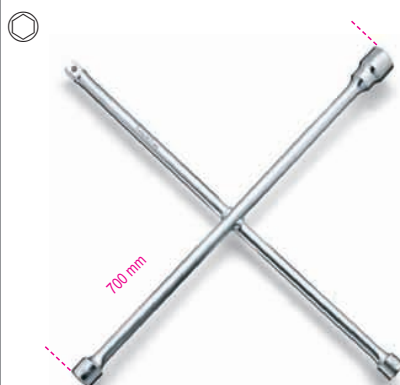

UNI/ISO 6788 DIN 3119

982	2	009820001
24x27x32x3/4 mm		

989

wheel balancing weight tool



L mm	2	009890001
250		

990

straight thin knurled point spring tweezers made from stainless steel bright finish



L mm	5	009900001
130		

991

bent thin knurled point spring tweezers made from stainless steel, bright finish



L mm	5	009910001
130		

992

straight thin knurled point pin spring tweezers made from stainless steel bright finish



L mm	5	009920001
150		

993

bent thin knurled point pin spring tweezers made from stainless steel bright finish



L mm	5	009930001
145		

993PL

bent thin knurled point pin spring tweezers made from stainless steel PVC-coated



L mm	5	009930010
150		

993G

pin spring tweezers, curved round ends, knurled made from stainless steel bright finish



L mm	5	009930030
160		

994

straight large knurled point spring tweezers made from stainless steel bright finish



L mm	5	009940001
150		

994PL

straight large knurled point spring tweezers made from stainless steel PVC-coated





L mm	5	009940010
150		

994TF

spring tweezers, acid and magnetic resistant, large round noses, strong and knurled ends made from stainless steel semi-bright finish



L mm 150   5 009940020

996

straight end spring tweezers with wide tips made from stainless steel bright finish





L mm 150   5 009960001

998

cross knurled end spring tweezers made from stainless steel bright finish



L mm 155   5 009980001

999

flat round end spring tweezers, acid and magnetic resistant made from stainless steel semi-bright finish





L mm 115   5 009990011

999A

extra slim short end spring tweezers, acid and magnetic resistant made from stainless steel semi-bright finish



L mm 120   5 009990015

999B

strong straight end spring tweezers, acid and magnetic resistant made from stainless steel semi-bright finish





L mm 120   5 009990017

999C

extra slim straight end spring tweezers, acid and magnetic resistant made from stainless steel semi-bright finish



L mm 110   5 009990019

999D

extra slim angled end spring tweezers, acid and magnetic resistant made from stainless steel semi-bright finish



L mm 115   5 009990021

999E

extra slim curved end spring tweezers, acid and magnetic resistant made from stainless steel semi-bright finish





L mm 120   5 009990023

999G

extra slim straight end spring tweezers, acid and magnetic resistant with stop mechanism made from stainless steel semi-bright finish



L mm 140   5 009990027

999/B6

set of 6 spring tweezers, acid and magnetic resistant



999/B6
999-999A-999B
999C-999D-999E

  1 009990050

1008

long flat knurled nose pliers, slip-proof double layer PVC coated handles



ISO 5745

L ~ L1 mm 160 51,5   5 010080006

1008BM

long flat knurled nose pliers bi-material handles



ISO 5745

L ~ L1 mm 160 51,5   5 010080036

1009

extra-long knurled nose pliers, slip-proof double layer PVC coated handles



L ~ L1 mm 160 51,5   2 010090006

1009L/A

extra long needle knurled nose pliers, for special operations, slip-proof double layer PVC coated handles



L mm	L1 mm	
283	80	2 010090008

1009L/B

curved extra long knurled nose pliers, 45°, for special operations, slip-proof double layer PVC coated handles



L mm	L1 mm	
273	73	2 010090009

1009L/C

bent extra long knurled nose pliers, 90°, for special operations, slip-proof double layer PVC coated handles



L mm	L1 mm	
253	45	2 010090010

1010

long round knurled nose pliers, slip-proof double layer PVC coated handles

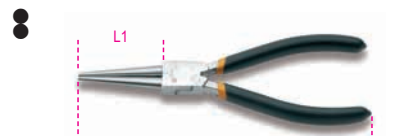

L mm	L1 mm	
160	51,5	2 010100006

1010BM

long round knurled nose pliers bi-material handles

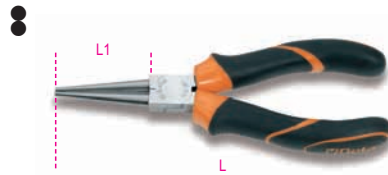

L mm	L1 mm	
160	51,5	2 010100036

1032

internal circlip pliers, straight pattern PVC-coated handles



L mm	∅ mm	L mm	
140	8÷25	142	5 010320013
180	19÷60	182	5 010320017
225	40÷100	227	3 010320021
300	85÷200	302	2 010320028

1033

internal circlip pliers, bent pattern, 45° PVC-coated handles



L mm	∅ mm	L mm	
140	8÷25	142	5 010330013
180	19÷60	182	5 010330017
225	40÷100	227	3 010330021

1034

internal circlip pliers, bent pattern, 90° PVC-coated handles



L mm	∅ mm	L mm	
130	8÷25	132	5 010340013
170	19÷60	172	5 010340017
210	40÷100	212	3 010340021
290	85÷200	292	2 010340028

1034L

90° curved long nose pliers for elastic safety rings for holes, PVC-coated handles



L mm	∅ mm	
192	40÷100	2 010340320

1036

external circlip pliers, straight pattern PVC-coated handles



L mm	∅ mm	L mm	
140x0,9	3÷10	142	5 010360013
140x1,3	10÷25	142	5 010360014
175	19÷60	177	5 010360017
225	40÷100	227	3 010360021
300	85÷200	302	2 010360028

1037

external circlip pliers, bent pattern, 45° PVC-coated handles



L mm	∅ mm	L mm	
140x0,9	3÷10	142	5 010370013
140x1,3	10÷25	142	5 010370014
175	19÷60	177	5 010370017
225	40÷100	227	3 010370021

1038

external circlip pliers, bent pattern, 90° PVC-coated handles



L mm	∅ mm	L mm	
135x0,9	3÷10	137	5 010380013
135x1,3	10÷25	137	5 010380014
175	19÷60	177	5 010380017
220	40÷100	222	3 010380021
300	85÷200	302	2 010380028

1039

straight point pliers for internal and external circlips PVC-coated handles



L	∅ mm	∅ mm	
150	10÷15	6÷25	2 010390015

1044

slip joint pliers overlapping joint PVC-coated handles



UNI 8608 ISO 8976

L	A max mm	L1 mm	
240	33	33	5 010440240

1044F

slip joint pliers overlapping joint PVC-coated handles



UNI 8608 ISO 8976

L	A max mm	L1 mm	
240	33	33	5 010440014

1046

slip joint pliers overlapping rack-type joint PVC-coated handles



UNI 8608 ISO 8976

L	A max mm	L1 mm	
240	28	33	5 010460240
400	107	55	1 010460400

1047

slip joint pliers, push button adjustment



L	A max mm	L1 mm	
240	36	35	2 010470240

1048

slip joint pliers boxed joints PVC-coated handles



UNI 8608 ISO 8976

L	A max mm	L1 mm	
175	30	30	3 010480175
240	34	33	5 010480240
300	46	40	2 010480300

1048V

slip joint pliers boxed joints, varnished



UNI 8608 ISO 8976

L	A max mm	L1 mm	
175	30	30	3 010480017
240	34	33	5 010480024
300	46	40	2 010480030

1050

double adjustment self-locking pliers



L mm		
220	2	010500022

1051

double adjustment self-locking pliers long jaws



L mm		
255	2	010510025

1051GM

double adjustment self-locking pliers, floating jaw

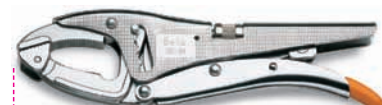

L mm		
255	2	010510250

1052

adjustable self-locking pliers, concave jaws

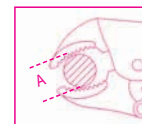

L	A max mm	
140	22	3 010520014
190	36	3 010520019
240	42	3 010520024
300	55	2 010520030

1053

adjustable self-locking pliers, floating jaw

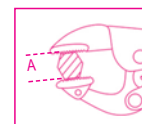

A max mm	L mm	
35	240	2 010530024

1053GM2

adjustable self-locking pliers,
floating jaws

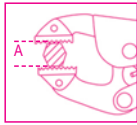

A max mm	L mm		
47	240	2	010530124

1054

adjustable self-locking pliers,
straight jaws

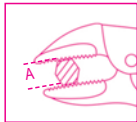

A max mm	L mm		
40	235	2	010540022

1055

adjustable self-locking pliers,
curved jaws

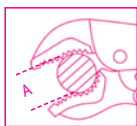

A max mm	L mm		
60	250	2	010550024

1056

adjustable self-locking pliers
for refrigerator engineers

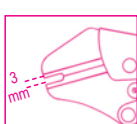
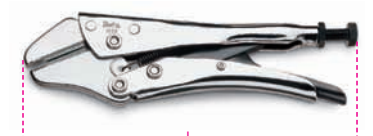

L mm			
190		2	010560019

1057A

automatic self-locking pliers with adjustable
force



L mm			
245		2	010570124

1058

adjustable self-locking pliers,
long jaws

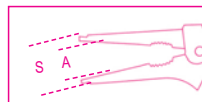

L ~	A max mm	S max mm		
180	38	/	2	010580018
240	65	100	2	010580024
310	80	150	2	010580031

1060

adjustable self-locking pliers,
fork-type jaws

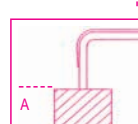

L ~	A max mm		
200	50	2	010600020
280	80	2	010600028

1060AL

adjustable self-locking pliers,
fork-type jaws, in aluminium

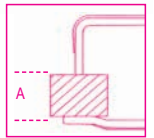

A max mm	L mm		
100	280	2	010600328

1061

adjustable self-locking pliers,
fork-type jaws

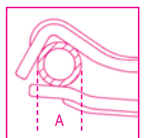

A max mm	L mm		
80	290	2	010610028

1062

adjustable self-locking pliers
with C-shaped jaws

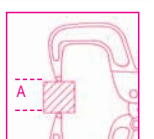

L ~	A max mm		
170	50	2	010620017
290	120	2	010620029
460	250	2	010620046

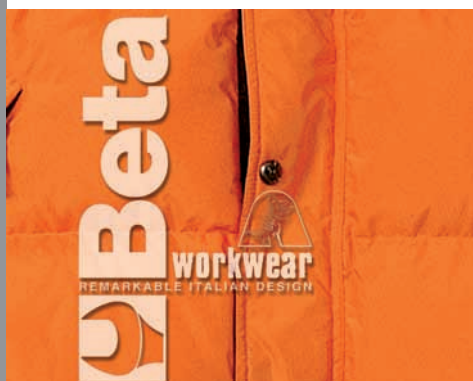

1062AL

adjustable self-locking pliers,
aluminium C-shaped jaws

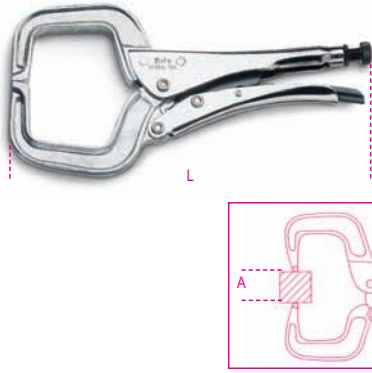

L ~	A max mm		
290	104	2	010620329
350	175	2	010620335

1062GM

adjustable self-locking pliers
with floating C-shaped jaws

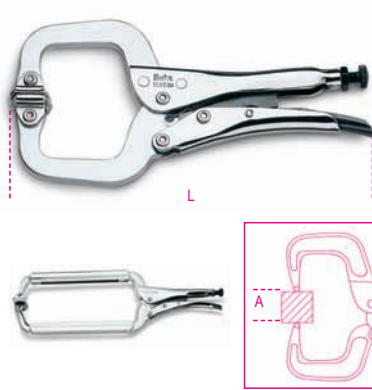

L ~	A max mm		
170	45	2	010620217
290	88	2	010620229
460	260	2	010620246

1063

adjustable self-locking pliers
for tinsmiths



A max mm	L mm		
30	200	2	010630020

1064

adjustable self-locking pliers with chain

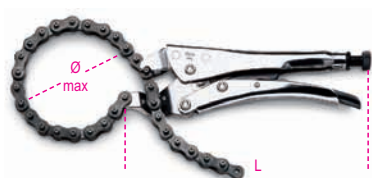

Ø mm	L mm		
150	240	2	010640024

1065F

hand punch steel punch and matrix

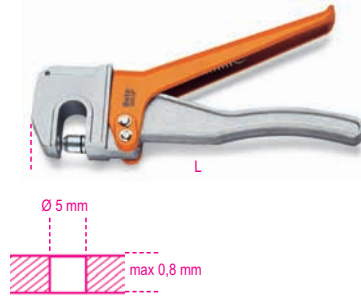

L mm			
228		2	010650010

1065P

hand crimper steel matrix



L mm			
228		2	010650020

1077

straight wide blade tinsmith's pliers,
PVC-coated handles



L ~	A mm	L1 mm		
260	60	50	2	010770026

1078

curved wide blade tinsmith's pliers,
45° PVC-coated handles



L ~	A mm	L1 mm		
260	60	45	2	010780026

1080

diagonal flush cutting nippers,
slip-proof double layer PVC coated handles

for cutting plastic



L ~	L1 mm		
140	20	3	010800004
160	22	3	010800006

1081S

diagonal ground cutting nippers
double layer PVC coated handles



UNI/ISO 5749

L ~	L1 mm	± mm		
140	20	1,6	5	010810014
160	22	1,6	5	010810016

1082

diagonal cutting nippers,
slip-proof double layer PVC coated handles

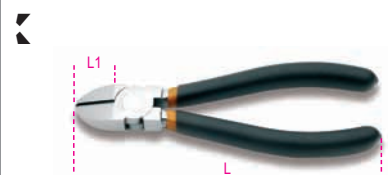

UNI/ISO 5749

L ~	L1 mm	± mm		
140	20	1,6	5	010820004
160	22	1,6	5	010820006

1082BM

diagonal cutting nippers,
bi-material handles



UNI/ISO 5749

L ~	L1 mm	± mm		
140	20	1,6	3	010820034
160	22	1,6	3	010820036

1082TM

diagonal cutting nippers
three-material handles



UNI/ISO 5749

L	L1	≡		
~	mm	mm		
140	20	1,6	3	010820044
160	22	1,6	3	010820046

1084

heavy duty diagonal cutting nippers,
slip-proof double layer PVC coated handles

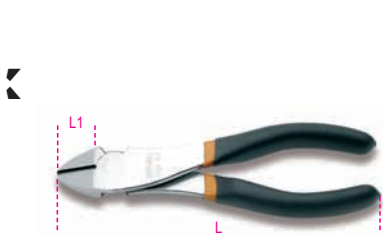

UNI/ISO 5749

L	L1	≡		
~	mm	mm		
140	19	1,4	5	010840004
160	21	1,6	5	010840006
180	25	1,8	3	010840008
200	26	2,0	3	010840010

1084BM

heavy duty diagonal cutting nippers
bi-material handles



UNI/ISO 5749

L	L1	≡		
~	mm	mm		
140	19	1,4	3	010840034
160	21	1,6	3	010840036
180	25	1,8	3	010840038
200	26	2,0	3	010840040

1084TM

heavy duty diagonal cutting nippers
three-material handles



UNI/ISO 5749

L	L1	≡		
~	mm	mm		
160	21	1,6	3	010840046
180	23	1,8	3	010840048
200	26	2,0	2	010840050

1088

heavy duty end cutting nippers,
slip-proof double layer PVC coated handles



UNI/ISO 5748

L	L1	≡		
~	mm	mm		
140	6	1,4	2	010880004
160	7	1,6	2	010880006
200	8	2,0	2	010880010

1088BM

heavy duty end cutting nippers,
bi-material handles



UNI/ISO 5748

L	L1	≡		
~	mm	mm		
140	6	1,4	2	010880034
160	7	1,6	2	010880036
200	8	2,0	2	010880040

1092V

toggle lever assisted end cutting nippers



UNI/ISO 5748

L	L1	≡		
~	mm	mm		
180	9	2,0	2	010920280
200	10	2,5	2	010920310

1094V

toggle lever assisted
diagonal cutting nippers



UNI/ISO 5749

L	L1	≡		
~	mm	mm		
200	23	2,5	2	010940200

1095N

toggle lever assisted
diagonal cutting nippers

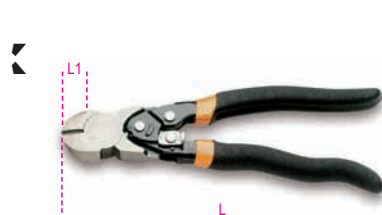

L	L1	≡		
~	mm	mm		
195	26	1,6	2	010950010

1096

carpenter's pincers



ISO 9243

L	L1			
~	mm			
160	21	5	010960016	
200	23	5	010960020	
250	30	5	010960025	

1098

construction worker's pincers



ISO 9242 DIN 5242

L	L1			
~	mm			
190	12	5	010980190	
220	13	5	010980220	
250	15	5	010980250	
280	18	5	010980280	

1098PL

construction worker's pincers,
PVC coated handles



ISO 9242 DIN 5242

L	L1		
~	mm		
220	13	5	010980320
250	15	5	010980350
280	18	5	010980380

1101

bolt cutter phosphatized blades
and rubber grip handles



L	L		
mm	mm		
300	12	2	011010030
350	14	2	011010035
450	18	1	011010045
600	24	1	011010060
750	30	1	011010075
900	36	1	011010090

L	R = 80	R = 140	g	
mm	Kgf=mm ² Ø mm	Kgf=mm ² Ø mm		
300	5	4	745	
350	6	5	1043	
450	7	6	1537	
600	9	7	2540	
750	11	8	3870	
900	12	9	6170	

1101R

spare blades for item 1101



mm	1101		
300	300	1	011010130
350	350	1	011010135
450	450	1	011010145
600	600	1	011010160
750	750	1	011010175
900	900	1	011010190

1102

bolt cutters, small series

Cutting capacity
R= \approx 80 Kgf/mm²



L			
~	mm		
230	4	3	011020020

1104

heavy-duty cable cutters,
handles with thermoplastic grips



L			
~	mm		
450	12	1	011040045
800	16	1	011040080

1104R

spare blades for item 1104



mm	1104		
450	450	1	011040145
800	800	1	011040180

1105

punches made from burnished steel

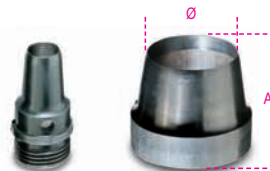

Ø	A		
mm	mm		
2	27	1	011050002
3	27	1	011050003
4	27	1	011050004
5	27	1	011050005
6	27	1	011050006
7	27	1	011050007
8	27	1	011050008
9	27	1	011050009
10	27	1	011050010
12	27	1	011050012
14	27	1	011050014
16	27	1	011050016
18	27	1	011050018
20	27	1	011050020
22	32	1	011050022
24	32	1	011050024
26	32	1	011050026
28	32	1	011050028
30	32	1	011050030
32	37	1	011050032
34	37	1	011050034
36	37	1	011050036
38	37	1	011050038
40	37	1	011050040
42	42	1	011050042
44	42	1	011050044
46	42	1	011050046
48	42	1	011050048
50	42	1	011050050

1105A

shank for punches 1105, 3 to 30 mm



L			
mm			
120		1	011050101

1105B

shank for punches 1105, 2 to 50 mm



L			
mm			
112		1	011050102

1105AD

shank adaptor for item 1105B



mm			
57		1	011050110

1105/C15

assortment of 15 punches, 3 to 30 mm



1105/C15			
		1	011050151

	1105	3 - 4 - 6 - 8 - 10 - 12 - 14 - 16
	1105A	18 - 20 - 22 - 24 - 26 - 28 - 30 mm
230x190x50 mm - 1100 g		

Beta

ISO 9001

1105/C29

assortment of 29 punches, 2 to 50 mm



1105/C29 1 011050152

1105 2-3-4-5-6-7-8-9-10-12
14-16-18-20-22-24-26-28
30-32-34-36-38-40-42-44
46-48-50 mm

1105B
1105AD

325x280x55 mm - 2700 g

1112

tin snips straight wide blades

Cutting capacity
R= 60 Kg/mm²



L ~	L1 mm	S mm	
200	50	0,5	2 011120020
250	62	0,8	2 011120025
300	76	1,0	2 011120030
375	105	1,2	1 011120037

1114

tin snips straight narrow blades

Cutting capacity
R= 60 Kg/mm²



L ~	L1 mm	S mm	
200	52	0,5	2 011140020
300	75	1,0	2 011140030

1118

safety strap cutting shears

Fe = normal steel
Inox = stainless steel



L ~	L1 mm	Fe S mm	Inox S mm	
310	42	1	0,8	2 011180001

1120A

hand nibbler

Fe = normal steel



L mm	Fe S mm	
280	1,2	1 011200101

1120ARL - ARG

spare parts for item 1120A



1120ARL	1 011200110
1120ARG	1 011200120

1122

compound leverage shears,
straight blades

Inox = stainless steel



L ~	L1 mm	Inox S mm	
250	40	1	2 011220020

1123

right cut compound leverage shears,
curved blades

Inox = stainless steel



L ~	L1 mm	Inox S mm	
250	40	1	2 011230020

1124

left cut compound leverage shears,
curved blades

Inox = stainless steel



L ~	L1 mm	Inox S mm	
250	40	1	2 011240020

1125

compound leverage shears
for straight and right cuts

Inox = stainless steel

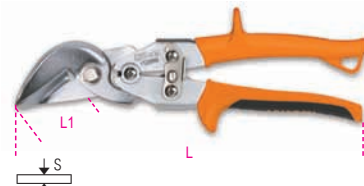

L ~	L1 mm	Inox S mm	
250	35	1	2 011250020

1126

compound leverage shears
for straight and left cuts

Inox = stainless steel

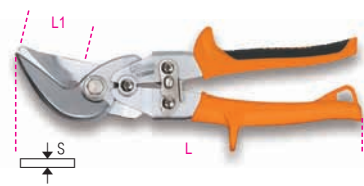

L mm	L1 mm	Inox S mm	
250	35	1	2 011260020

1127

telephone engineer's scissors,
straight blades



L mm	L1 mm	
150	35	5 011270001

1128BSX

electrician's scissors
with graduated milling profiles with case



L mm	L1 mm	
145	50	5 011280060

1128BMX

electrician's scissors,
straight stainless steel blades,
with microteeth



L mm	L1 mm		
145	54	5	011280050

1128BM

electrician's scissors, straight blades



L mm	L1 mm		
145	50	5	011280000

1128P/BM

electrician's scissors, heavy series,
straight blades



L mm	L1 mm		
145	48	5	011280100

1129BM

electrician's scissors, curved blades



L mm	L1 mm		
145	44	5	011290000

1130BMX

multipurpose scissors,
straight stainless steel blades,
with microteeth



L mm	L1 mm		
200	58	1	011300000

1131CK

Kevlar® and fibre optics scissors



L mm	L1 mm		
203	75	1	011310001

1132

cable cutters for insulated copper
and aluminium cables,
slip-proof double layer PVC coated handles



UNI 8791			
L mm	mm		
170	10	2	011320107
230	17	2	011320113

1132BM

cable cutters for insulated copper
and aluminium cables,
bi-material handles



UNI 8791			
L mm	mm		
170	10	2	011320137
230	17	2	011320143

1133

cable cutter for copper cables, flexible

up to 325 mm²



L mm	mm		
600	30	1	011330001

1133RL

spare blades for item 1133



1133RL			
		1	011330011

1134

ratchet cable cutters burnished finish,
plastic handles



L mm	mm		
260	35	1	011340032

1134RL

spare blade for item 1134



1134RL			
		1	011340132

1134A

ratchet cable cutters burnished finish,
plastic handles



L mm	mm		
240	45	1	011340045

1134A/RL

spare blade for item 1134A



1134A/RL			
		1	011340145

1136

cable cutter for steel cables

Cutting capacity
Ø 5 mm for cable R ≤ 160 Kg/mm²
Ø 4 mm for mild steel bolts



L mm			
165		2	011360001

1142

wire stripping pliers,
slip-proof double layer PVC coated handles



UNI 7923

L	mm	mm ²		
160	0,5÷6		5	011420006

1142BM

wire stripping pliers,
bi-material handles



UNI 7923

L	mm	mm ²		
160	0,5÷6		3	011420036

1143

wire stripping pliers with cutting device



L	mm	mm ²		
165	0,5÷6		1	011430001

1143R

spare blades for item 1143

1143R			1	011430011
-------	--	--	---	-----------

1144

cable stripping tool



L	mm	mm ²		
140	6÷20		1	011440014

1144RC

spare blade for item 1144



1144RC			1	011440015
--------	--	--	---	-----------

1144D

cable stripping tool



L	mm	mm ²		
170	4,5÷40		1	011440010

1144D/RG

spare hook for item 1144D



1144D/RG			1	011440012
----------	--	--	---	-----------

1144D/RL

spare blades for item 1144D

1144D/RL			1	011440011
----------	--	--	---	-----------

1145

wire stripping pliers,
self-adjusting model



L	mm	mm ²		
165	0,25÷1,5		1	011450018

1145RG

pair of spare jaws for item 1145



1145RG			1	011450020
--------	--	--	---	-----------

1148A

wire stripping pliers, self-adjusting,
with cutting device
cutting capacity
≠10 mm² (8 AWG) flexible wires
≠1,5 mm² (16 AWG) sturdy wires



L	mm	mm ²		
190	0,02÷10		1	011480100
		34÷8 AWG		

1148A/R

spare blades for item 1148A



1148A/R			1	011480102
---------	--	--	---	-----------

1148B

wire stripping pliers, self-adjusting,
with cutting device
cutting capacity
≠10 mm² (8 AWG) flexible wires
≠1,5 mm² (16 AWG) sturdy wires



L	mm	mm ²		
190	4÷16		1	011480200
		12÷6 AWG		

1148B/R

spare blades for item 1148B



1148B/R			1	011480202
---------	--	--	---	-----------

1149F

front wire stripping pliers with cutting blade,
self-adjusting



L	mm	mm ²		
175	0,2 ÷ 6		1	011490010
		28÷17 AWG		

1150

combination pliers
bright chrome-plated,
slip-proof double layer PVC coated handles

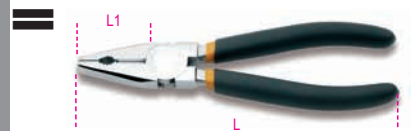

ISO 5746

L	mm	L1	mm	mm		
160	37		1,6		5	011500006
180	39		1,8		5	011500008
200	43		2,0		5	011500010
220	46		2,0		2	011500012

1150BM

combination pliers bright chrome-plated, bi-material handles



ISO 5746

L	L1	mm		
~	mm	mm		
160	37	1,6	3	011500036
180	39	1,8	3	011500038
200	43	2,0	3	011500040
220	46	2,0	2	011500042

1162

extra long flat knurled nose pliers, slip-proof double layer PVC coated handles



ISO 5745

L	L1	mm		
~	mm	mm		
160	56	1,6	5	011620006
200	76	1,6	5	011620010

1166

extra long needle knurled nose pliers, slip-proof double layer PVC coated handles



ISO 5745

L	L1	mm		
~	mm	mm		
160	56	1,6	5	011660006
200	76	1,6	5	011660010

1151S

combination pliers ground, PVC-coated handles



ISO 5746

L	L1	mm		
~	mm	mm		
160	37	1,6	5	011510016
180	39	1,8	5	011510018
200	43	2,0	5	011510020
220	46	2,0	3	011510022

1162BM

extra long flat knurled nose pliers bi-material handles



ISO 5745

L	L1	mm		
~	mm	mm		
160	56	1,6	3	011620036
200	76	1,6	3	011620040

1166BM

extra long needle knurled nose pliers, bi-material handles



ISO 5745

L	L1	mm		
~	mm	mm		
160	56	1,6	3	011660036
200	76	1,6	3	011660040

1152TM

combination pliers, high cutting capacity, bright chrome-plated three-material handles



ISO 5746

L	L1	mm		
~	mm	mm		
160	37	1,6	3	011520046
180	39	1,8	3	011520048
200	43	2,0	3	011520050

1164

extra long bent flat knurled nose pliers, slip-proof double layer PVC coated handles



ISO 5745

L	L1	mm		
~	mm	mm		
160	53	1,6	5	011640006
200	70	1,6	5	011640010

1168

extra long bent needle knurled nose pliers, slip-proof double layer PVC coated handles



ISO 5745

L	L1	mm		
~	mm	mm		
160	50	1,6	5	011680006
200	70	1,6	5	011680010

1153

adjustable pliers, two positions, PVC-coated handles



L	L1	mm		
~	mm	mm		
160	35		2	011530016
200	43		2	011530020

1164BM

extra long bent flat knurled nose pliers, bi-material handles



ISO 5745

L	L1	mm		
~	mm	mm		
160	53	1,6	3	011640036
200	70	1,6	3	011640040

1168BM

extra long bent needle knurled nose pliers, bi-material handles



ISO 5745

L	L1	mm		
~	mm	mm		
160	50	1,6	3	011680036
200	70	1,6	3	011680040

1171BM

smooth, flat short nose pliers
bi-material handles

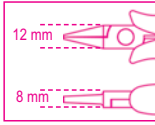

ISO 9655

L L1
~ mm
125 18 2 011710101

1173BM

round short nose pliers
bi-material handles

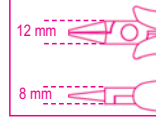

ISO 9655

L L1
~ mm
125 22 2 011730101

1177BM/Z

half-round long knurled nose pliers
bi-material handles

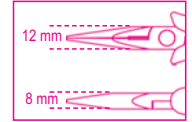

ISO 9655

L L1
~ mm
140 39 2 011770113

1172BM

smooth, flat long nose pliers
bi-material handles

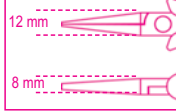

ISO 9655

L L1
~ mm
140 40 2 011720101

1175BM

smooth half-round short nose pliers
bi-material handles

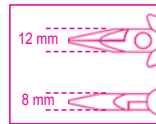

ISO 9655

L L1
~ mm
125 29 2 011750101

1178BM

smooth half-round long needle nose pliers
bi-material handles

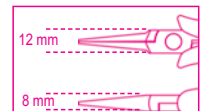

ISO 9655

L L1
~ mm
140 37 2 011780101

1172BM/P

smooth, flat bent long nose pliers
bi-material handles

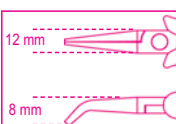

L L1
~ mm
140 38 2 011720102

1177BM

smooth half-round long nose pliers
bi-material handles

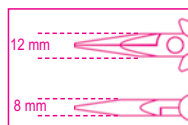

ISO 9655

L L1
~ mm
140 38 2 011770101

1178BM/P

smooth half-round long bent
needle nose pliers
bi-material handles

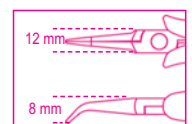

L L1
~ mm
140 36,5 2 011780102

1182BM

diagonal semi-flush cutting nippers,
slim tips
bi-material handles



ISO 9654

L mm	L1 mm	A mm	Cu mm		
120	11	10	1,25	2	011820101

1185BM

diagonal flush cutting nippers,
slim tips
bi-material handles



ISO 9654

L mm	L1 mm	A mm	Cu mm		
120	11	10	1	2	011850101
130	13	12,5	1,5	2	011850102

1190BM

end semi-flush cutting nippers
bi-material handles



ISO 9654

L mm	L1 mm	A mm	Cu mm		
120	12	12	1,25	2	011900113

1183BM

diagonal semi-flush cutting nippers,
rounded tips
bi-material handles



ISO 9654

L mm	L1 mm	A mm	Cu mm		
120	11	10	1,25	2	011830101

1186BM

diagonal flush cutting nippers,
slim tapering tips
bi-material handles



ISO 9654

L mm	L1 mm	A mm	Cu mm		
120	11	10	1	2	011860101
130	13	12,5	1,5	2	011860102

1191BM

end flush oblique cutting nippers
bi-material handles



ISO 9654

L mm	L1 mm	A mm	Cu mm		
130	8	12	0,8	2	011910101

1184BM

diagonal flush cutting nippers,
rounded tips
bi-material handles



ISO 9654

L mm	L1 mm	A mm	Cu mm		
120	11	10	1	2	011840101
130	13	12,5	1,5	2	011840102

1188BM

diagonal axial cutting nippers
bi-material handles



ISO 9654

L mm	L1 mm	A mm	S mm		
125	12	12	1,25	2	011880101
130	17	15	2	2	011880102

1191BM/L

end flush long oblique cutting nippers
bi-material handles



ISO 9654

L mm	L1 mm	A mm	Cu mm		
130	18	12	1	2	011910110

1200MS

magnetizer/demagnetizer

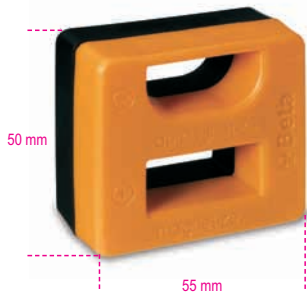

1200MS 5 012000000

1201

screwdrivers for slotted head screws



UNI 10562 ISO 2380 DIN 5265

SxAxL mm	L1 mm		
0,4x2,5x50	146	5	012010003
0,4x2,5x75	166	5	012010006
0,5x3x75	171	5	012010009
0,5x3x100	196	5	012010012
0,6x3,5x100	196	5	012010021
0,8x4x100	196	5	012010030
0,8x4x125	221	5	012010033
1,0x5,5x100	209	5	012010039
1,0x5,5x150	259	5	012010042
1,2x6,5x150	270	5	012010051
1,2x8x150	282	3	012010057
1,6x10x200	332	3	012010066



1201/S6 1 012010206
0,5x3x75-0,6x3,5x100
0,8x4x100-1,0x5,5x100
1,2x8x150-1,6x10x200 mm

1201N

screwdrivers for slotted head screws,
extra-short series



UNI 10562 DIN 5265

SxAxL mm	L1 mm		
0,8x4x30	86,5	3	012010103
1,2x6,5x30	86,5	3	012010106

1201DZ

screwdriver for Dzus® head screws

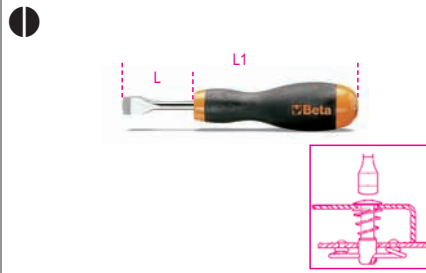

1201DZ 2 012010501
L mm 53 L1 mm 173

1202

screwdrivers for cross head
Phillips® screws



UNI/ISO 8764 DIN 5262

PHxDxL mm	L1 mm		
0x3x60	156	5	012020003
1x4,5x80	189	5	012020009
1x4,5x120	229	5	012020012
2x6x100	220	5	012020018
2x6x150	270	5	012020021
3x8x150	282	3	012020024
4x9,5x200	332	3	012020027



1202/S4 1 012020204
PH0x3x60-PH1x4,5x120
PH2x6x150-PH3x8x150 mm

1202N

screwdrivers
for cross head Phillips® screws,
extra-short series

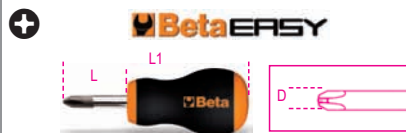

UNI/ISO 8764 DIN 5262

PHxDxL mm	L1 mm		
1x4,5x30	86,5	3	012020103
2x6x30	86,5	3	012020106

1203/D

set of screwdrivers



1203/D5 1 012030001

1201 0,6x3,5x100-1,0x5,5x150
1,2x6,5x150 mm

1202 PH1x4,5x80-PH2x6x100 mm

1203/D7 1 012030007

1201 0,5x3x75-0,8x4x100
1,0x5,5x100-1,2x6,5x150 mm

1202 PH0x3x60-PH1x4,5x80
PH2x6x100 mm

1203/D8 1 012030008

1201 0,5x3x75-0,8x4x125
1,0x5,5x150-1,2x6,5x150 mm

1202 PH0x3x60-PH1x4,5x80
PH2x6x100-PH3x8x150 mm

1203/D10 1 012030010

1201 0,4x2,5x50-0,5x3x75
0,8x4x100-1,0x5,5x100
1,2x6,5x150-1,2x8x150 mm

1202 PH0x3x60-PH1x4,5x80
PH2x6x100-PH3x8x150 mm

1203/D6 1 012030006

1202 PH1x4,5x80-PH2x6x100 mm

1204 0,4x2,5x60-0,5x3x100
0,8x4x100-1,0x5x125 mm

1203/D5PZ 1 012030003

1201 0,5x3x75-0,8x4x125
1,0x5,5x150 mm

1209PZ PZ1x4,5x80-PZ2x6x100 mm

1203/S10



1203/S10 1 012030021

1201 0,4x2,5x50-0,5x3x75
0,8x4x125-1,0x5,5x150
1,2x6,5x150-1,2x8x150 mm

1202 PH0x3x60-PH1x4,5x80
PH2x6x100-PH3x8x150 mm

1204

screwdrivers for headless slotted screws



SxDxL mm	L1 mm		
0,4x2,5x60	156	5	012040003
0,5x3x100	196	5	012040009
0,8x4x100	196	5	012040012
1x5x125	234	5	012040018
1,2x6,5x150	270	5	012040024



1204/S5	1	012040205
0,4x2,5x60-0,5x3x100		
0,8x4x100-1x5x125		
1,2x6,5x150 mm		

1207TX

screwdrivers for Torx® head screws, with handles



T	L mm	L1 mm		
T6	60	156	5	012070006
T7	60	156	5	012070007
T8	60	156	5	012070008
T9	60	156	5	012070009
T10	80	189	5	012070010
T15	80	189	5	012070015
T20	100	209	5	012070020
T25	100	209	5	012070025
T27	100	220	5	012070027
T30	100	220	5	012070030



1207TX/D7	1	012070207
T6-T8-T10-T15		
T20-T25-T30		

1208RTX

screwdrivers for Tamper Resistant Torx® head screws, with handles



T	L mm	L1 mm		
T9	60	156	5	012080009
T10	80	189	5	012080010
T15	80	189	5	012080015
T20	100	209	5	012080020
T25	100	209	5	012080025
T27	100	220	5	012080027
T30	100	220	5	012080030



1208RTX/D7	1	012080207
T9-T10-T15-T20		
T25-T27-T30		

1209PZ

screwdrivers for cross head Pozidriv®-Supadriv® screws



UNI/ISO 8764

PZ	L mm	L1 mm		
0	60	156	5	012090000
1	80	189	5	012090003
2	100	220	5	012090006
3	150	282	3	012090009



1209PZ/S4	1	012090204
PZ0-PZ1-PZ2-PZ3		



1227

screwdrivers for slotted head screws

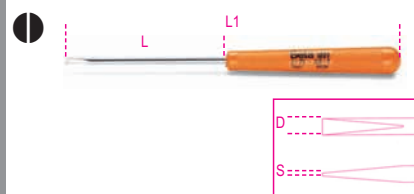

SxDxL mm	L1 mm		
0,5x2,5x60	145	10	012270010
0,6x3x75	160	10	012270020
0,6x3x100	185	10	012270030
0,8x4x100	210	10	012270040
0,8x4x150	260	10	012270050

1228

screwdrivers for cross head Phillips® screws

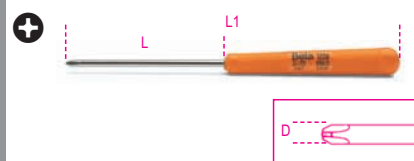

PHxDxL mm	L1 mm		
0x3x75	160	10	012280030
1x4,5x100	210	10	012280045

1229LP

micro-screwdrivers for headless slotted screws

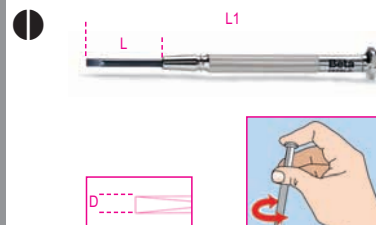

D mm	L mm	L1 mm		
1,0	17	75	5	012290210
1,2	21	85	5	012290212
1,4	21	89	5	012290214
1,8	23	94	5	012290218
2,0	23	98	5	012290220
2,4	26	103	5	012290224
3,0	28	108	5	012290230



1229LP/A6	1	012290300
1,2-1,4-1,8-2-2,4-3 mm		

1229PH

micro-screwdrivers for cross head Phillips® screws

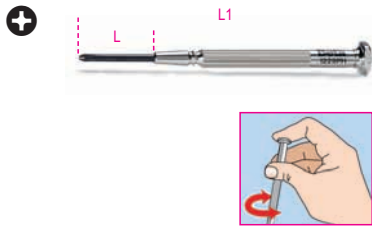

PH	L mm	L1 mm		
0	26	102	5	012290250
1	29	107	5	012290251

1229LPH/A6

set of 6 micro-screwdrivers
items 1229LP-1229PH



1229LPH/A6			1	012290310
1229LP	1,4-1,8-2,4-3			
1229PH	0-1			

1236B

offset screwdrivers
for slotted head screws



UNI 7079 DIN 5200

SxA mm	L mm		
0,8x4	100	5	012360201
1x5,5	125	5	012360202
1,2x8	150	5	012360204

1238B

offset screwdrivers
for cross head Phillips® screws



UNI 7083 DIN 5208

PH	L mm		
1-2	125	5	012380201
3-4	200	5	012380203

1241

screwdrivers with steel head for slotted head screws

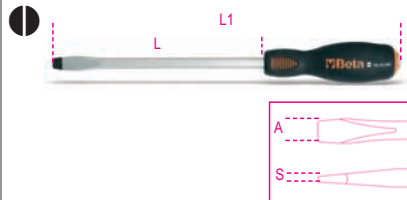

UNI 10562 ISO 2380 DIN 5265

SxAxL mm	L1 mm		
1x5,5x100	202	5	012410039
1,2x6,5x125	240	5	012410050
1,2x8x150	248	3	012410057
1,6x10x200	325	2	012410066

1242

screwdrivers with steel head for cross head Phillips® screws



UNI/ISO 8764 DIN 5262

PHxDxL mm	L1 mm		
1x4,5x100	202	5	012420209
2x6x100	215	5	012420218
3x8x150	248	3	012420221
4x11x200	325	2	012420224

1243/D7

screwdriver set



1243/D7		1	012430017
1241	1x5,5x100-1,2x6,5x125 1,2x8x150-1,6x10x200 mm		
1242	PH1x4,5x100-PH2x6x100 PH3x8x150 mm		

1249PZ

screwdrivers with steel head for slotted head Pozidriv®-Supadriv® screws

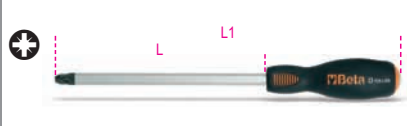

UNI/ISO 8764

PZ	L mm	L1 mm		
1	100	202	3	012490003
2	100	215	3	012490006
3	150	248	2	012490009

1250

screwholding screwdrivers
for slotted head screws

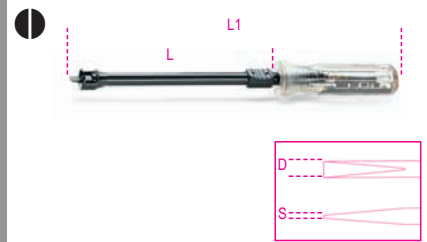

SxDxL mm	L1 mm		
0,5x3x125	190	5	012500030
0,6x4x125	225	5	012500040
0,7x5x150	255	5	012500050

1251

screwholding screwdrivers
for cross head Phillips® screws

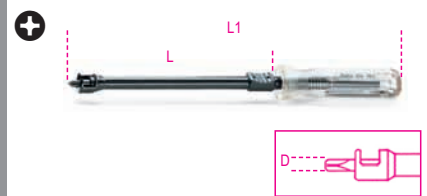

PHxDxL mm	L1 mm		
0x4x125	225	5	012510000
1x5x150	255	5	012510010
2x6x175	280	5	012510020

1252/S5



1252/S5		1	012520001
1250	0,5x3x125-0,6x4x125 0,7x5x150 mm		
1251	PH1x5x150-PH2x6x175 mm		

1253

mains testing screwdriver 150/250V

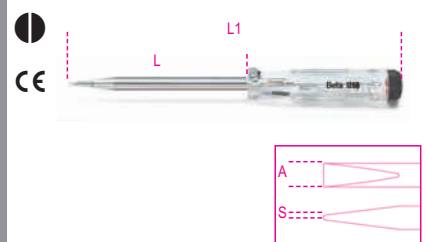

SxAxL mm	L1 mm		
0,5x3,5x100	190	5	012530001

1253A

mains testing screwdriver 125/250V,
double insulation

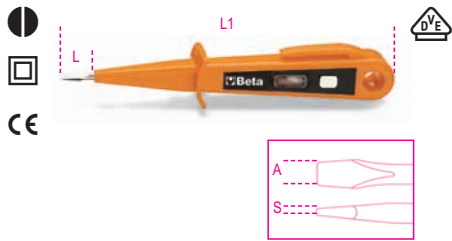

SxAxL mm	L1 mm		
0,5x3x15	150	5	012530010

1254

circuit testing screwdriver 6-24V

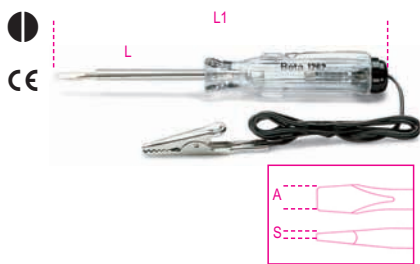

SxAxL mm	L1 mm		
0,5x3x44	123	5	012540001

1255LP

micro-screwdrivers
for slotted head screws

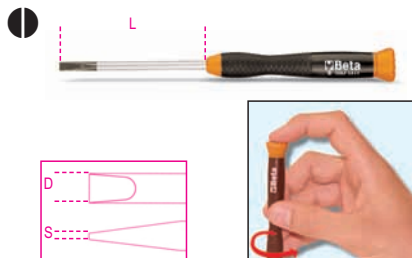

SxD mm	L mm		
0,2x1,2	50	5	012550012
0,25x1,5	50	5	012550015
0,3x1,8	50	5	012550018
0,4x2	75	5	012550020
0,4x2,4	75	5	012550024
0,5x3	75	5	012550030
0,6x3,5	75	5	012550035
0,8x4	75	5	012550040



1255LP/S8			
0,2x1,2-0,25x1,5		5	012550100
0,3x1,8-0,4x2-0,4x2,4			
0,5x3-0,6x3,5-0,8x4 mm			

1255PH

micro-screwdrivers
for cross-head Phillips® screws



PH	L mm		
00	75	5	012550060
0	75	5	012550063
1	75	5	012550066

1255LPH/S8



1255LPH/S8			
1255LP	0,4x2-0,4x2,4-0,5x3 0,6x3,5-0,8x4 mm	1	012550110
1255PH	PH00-PH0-PH1		

1255ES

micro-screwdrivers hexagon male ends



mm	L mm		
0,9	75	5	012550045
1,3	75	5	012550046
1,5	75	5	012550047
2	75	5	012550048
2,5	75	5	012550049
3	75	5	012550050

1255ESB/S8



1255ESB/S8			
1255ES	0,9-1,3-1,5-2-2,5-3 mm	1	012550130
1255BE	4-5 mm		

1255TX

micro-screwdrivers for Torx®
head screws



T	L mm		
T5	75	5	012550075
T6	75	5	012550076
T7	75	5	012550077
T8	75	5	012550078
T9	75	5	012550079
T10	75	5	012550080
T15	75	5	012550081
T20	75	5	012550082



1255TX/S8			
T5-T6-T7-T8		1	012550120
T9-T10-T15-T20			

1255BE

micro-screwdrivers hexagon socket wrenches



mm	L mm		
3,2	75	5	012550085
4	75	5	012550086
5	75	5	012550087
5,5	75	5	012550088



1260

screwdrivers for slotted head screws



UNI 10562 ISO 2380 DIN 5265

SxAxL mm	L1 mm		
0,4x2,5x50	150	5	012600003
0,4x2,5x75	175	5	012600006
0,5x3x75	175	5	012600009
0,5x3x100	200	5	012600012
0,6x3,5x75	175	5	012600018
0,6x3,5x100	200	5	012600021
0,8x4x100	208	5	012600030
0,8x4x125	233	5	012600033
0,8x4x150	258	5	012600036
1x5,5x100	208	5	012600039
1x5,5x125	233	5	012600040
1x5,5x150	258	5	012600042
1,2x6,5x100	219	5	012600048
1,2x6,5x125	244	5	012600050
1,2x6,5x150	269	5	012600051
1,2x8x150	277	3	012600057
1,2x8x200	327	3	012600060
1,6x10x200	327	3	012600066
2x12x250	377	3	012600069

1260E

screwdrivers for slotted head screws
with hexagon bolsters



UNI 10562 ISO 2380 DIN 5265

SxAxL mm	L1 mm		
1,2x6,5x150	269	3	012600156
1,2x8x175	301	3	012600157
1,6x10x200	327	2	012600159
2x12x250	377	2	012600162

1262

screwdrivers
for cross head Phillips® screws



UNI/ISO 8764 DIN 5262

PHxDxL mm	L1 mm		
0x3x60	160	5	012620003
0x3x100	200	5	012620006
1x4,5x80	188	5	012620009
1x4,5x120	228	5	012620012
2x6x100	219	5	012620018
2x6x150	269	5	012620021
3x8x150	277	3	012620024
4x10x200	327	3	012620027

1262/S4
PH0x3x60-PH1x4,5x80
PH2x6x100-PH3x8x150 mm

1 012620304

1260N

screwdrivers for slotted head screws,
extra-short series



UNI 10562 DIN 5265

SxAxL mm	L1 mm		
0,8x4x30	87	5	012600103
1,2x6,5x30	87	5	012600106

1262N

screwdrivers
for cross head Phillips® screws,
extra-short series



UNI/ISO 8764 DIN 5262

PHxDxL mm	L1 mm		
1x4,5x30	87	5	012620103
2x6x30	87	5	012620106

1262E

screwdrivers
for cross head Phillips® screws
with hexagon bolsters



UNI/ISO 8764

PHxDxL mm	L1 mm		
2x6x150	269	3	012620153
3x8x175	302	3	012620156
4x10x200	327	2	012620159

1262L

screwdrivers
for cross head Phillips® screws,
long series



UNI/ISO 8764-1

PHxDxL mm	L1 mm		
0x3x300	400	3	012620203
1x4,5x400	508	3	012620206
2x6x400	519	3	012620209

Beta



1263/D...

set of screwdrivers



1263/D5 1 012630005

1260 0,5x3x75-0,8x4x100

1x5,5x125 mm

1262 PH1x4,5x80-PH2x6x100 mm



1263/D6 1 012630006

1260 0,5x3x75-0,8x4x100

1x5,5x125-1,2x6,5x150 mm

1262 PH1x4,5x80-PH2x6x100 mm



1263/D7 1 012630017

1262 PH0x3x60-PH1x4,5x80

PH2x6x100 mm

1264 0,5x2,5x60-0,6x3x100

0,8x4x125-1x5x125 mm



1263/D7PZ 1 012630007

1260 0,5x3x75-0,8x4x100

1x5,5x150-1,2x6,5x150 mm

1269PZ PZ0 - PZ1 - PZ2



1263/D8 1 012630008

1260 0,4x2,5x75-0,5x3x75

0,8x4x100-1x5,5x125

1,2x6,5x150 mm

1262 PH0x3x60-PH1x4,5x80

PH2x6x100 mm



1263/D10 1 012630010

1260 0,5x3x75-0,6x3,5x100

0,8x4x125-1x5,5x150

1,2x6,5x150 mm

1260N 0,8x4x30

1262 PH0x3x60-PH1x4,5x80

PH2x6x100 mm

1262N PH1x4,5x30

1263/S12

set of 12 screwdrivers



1263/S12 1 012630112

1260 0,4x2,5x50-0,5x3x75

0,6x3,5x100-0,8x4x125

1x5,5x125-1,2x6,5x150

1,2x8x200-1,6x10x200 mm

1262 PH0x3x60-PH1x4,5x80

PH2x6x100-PH3x8x150 mm

1264

screwdrivers for headless slotted screws

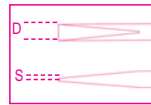

SxDxL L1

mm mm mm

0,5x2,5x60 160 5 012640003

0,6x3x75 175 5 012640006

0,6x3x100 200 5 012640009

0,8x4x100 208 5 012640012

0,8x4x125 233 5 012640015

1x5x125 233 5 012640018

1x5x150 258 5 012640021

1,2x6,5x150 269 5 012640024



1264/S5 1 012640305

0,5x2,5x60-0,6x3x75

0,8x4x100-1x5x125-1,2x6,5x150 mm

1264L

screwdrivers for headless slotted screws,
long series

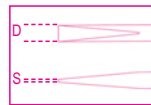

SxDxL L1

mm mm mm

0,5x2,5x200 300 3 012640203

0,6x3x300 400 3 012640206

0,8x4x400 508 3 012640209

1x5x400 508 3 012640215

1,2x6,5x400 519 3 012640218

1265ES

hexagon drivers
with handles



mm L L1

mm mm mm

1,5 100 200 3 012650015

2 100 200 3 012650020

2,5 100 200 3 012650025

3 100 200 3 012650030

mm	L mm	L1 mm		
4	100	208	3	012650040
5	100	219	3	012650050
6	125	244	3	012650060
8	150	277	2	012650080



1265ES/S8 1 012650308

1,5-2-2,5-3-4-5-6-8 mm

1266BP

ball head hexagon drivers
with handles



mm L L1

mm mm mm

2 100 200 3 012660020

2,5 100 200 3 012660025

3 125 225 3 012660030

4 125 233 3 012660040

5 120 239 3 012660050

6 140 259 3 012660060

8 160 287 2 012660080

10 160 287 2 012660100



1266BP/S8 1 012660308

2-2,5-3-4-5-6-8-10 mm

1267TX

drivers for Torx® head screws,
with handles



L L1

mm mm mm

T5 50 150 5 012670005

T6 50 150 5 012670006

T7 50 150 5 012670007

T8 60 160 5 012670008

T9 60 167 5 012670009

T10 80 188 5 012670010

	L mm	L1 mm		
T15	80	188	5	012670015
T20	100	208	5	012670020
T25	100	208	5	012670025
T27	115	234	5	012670027
T30	115	234	5	012670030
T40	130	257	2	012670040
T45	130	257	2	012670045



1267TX/D7
T6-T8-T10-T15
T20-T25-T30



1267TX/S13
T5-T6-T7-T8-T9
T10-T15-T20-T25
T27-T30-T40-T45



1268RTX

screwdrivers for Tamper Resistant Torx® head screws, with handles



	L mm	L1 mm		
T9	60	167	3	012680009
T10	80	188	3	012680010
T15	80	188	3	012680015
T20	100	208	3	012680020
T25	100	208	3	012680025
T27	115	234	3	012680027
T30	115	234	3	012680030
T40	130	257	2	012680040



1268RTX/S7
T9-T10-T15-T20
T25-T27-T30-T40



1269PZ

screwdrivers for cross head Pozidriv®-Supadriv® screws



UNI/ISO 8764

PZ	L mm	L1 mm		
0	100	160	5	012690000
1	108	188	5	012690001
2	119	219	5	012690002
3	127	277	3	012690003
4	127	327	3	012690004



1269PZ/S4
PZ0-PZ1-PZ2-PZ3



1269N/PZ

screwdrivers for cross head Pozidriv®-Supadriv® screws, extra-short series



UNI/ISO 8764

PZ	L mm	L1 mm		
1	30	87	5	012690011
2	30	87	5	012690012

1281

interchangeable blade screwdriver handle



L mm
108



1281PM

quick-fit magnetic bit holder



L mm
165



1281PB

socket holder with 1/4" male drive



L mm
175



1281LP

reversible screwdrivers for slotted head screws



1281LP/1
0,8x4-1,2x6,5 mm

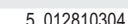

1281PH

reversible screwdrivers for cross head Phillips® screws



PH
1-2



1281LPH

reversible screwdrivers for slotted and Phillips® head screws



1281LPH/1
PH0-0,8X4 mm

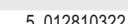

1281PZ

reversible screwdrivers for cross head Pozidriv®-Supadriv® screws



PZ
1-2

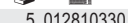

1281PE

reversible ball head hexagon
screwdriver blades



mm	
2,5	5 012810342
3	5 012810343
4	5 012810344
5	5 012810345
6	5 012810346

1281TX

reversible screwdrivers for Torx® head screws



1281TX/1 T6-T8	5 012810349
1281TX/2 T7-T9	5 012810350
1281TX/3 T10-T15	5 012810351
1281TX/4 T20-T25	5 012810352
1281TX/5 T30-T40	5 012810353

1281RTX

reversible screwdrivers
for Tamper Resistant Torx® head screws



1281RTX/3 T10-T15	5 012810361
1281RTX/4 T20-T25	5 012810362
1281RTX/5 T30-T40	5 012810363

1281/A9

assortment of 9 reversible screwdrivers
and 1 accessory in case



1281/A9 1 012810609

1281	
1281LPH/1	PH0-0,8x4 mm
1281LPH/2	PH1-1x5,5 mm
1281LPH/3	PH2-1,2x6,5 mm
1281PZ/1	PZ1-PZ2
1281PE	2,5 mm
1281PE	3 mm
1281PE	4 mm
1281PE	5 mm
1281PE	6 mm

1281TX/A8

assortment of 8 reversible screwdrivers
and 1 accessory in case



1281TX/A8 1 012810619

1281	
1281LPH/1	PH0-0,8x4 mm
1281LPH/2	PH1-1x5,5 mm
1281LPH/3	PH2-1,2x6,5 mm
1281TX/1	T6-T8
1281TX/2	T7-T9
1281TX/3	T10-T15
1281TX/4	T20-T25
1281TX/5	T30-T40

1281/B28A

set of 16 reversible screwdrivers,
9 1/4" drive sockets,
2 accessories and 1 handle, in wallet



1281/B28A 1 012810500

900	4 - 4,5 - 5 - 5,5 6 - 7 - 8 - 9 - 10 mm
1281	⊕
1281PB	■ 1/4
900/25	
1281LP/1	0,8x4 - 1,2x6,5 mm
1281LP/2	1,0x5,5 - 1,2x6,5 mm
1281PH/1	PH1 - PH2
1281PH/2	PH2 - PH3
1281PZ/1	PZ1 - PZ2
1281PZ/2	PZ2 - PZ3
1281PE	2,5 - 3 - 4 - 5 - 6 mm
1281TX/1	T6 - T8
1281TX/2	T7 - T9
1281RTX/3	T10 - T15
1281RTX/4	T20 - T25
1281RTX/5	T30 - T40

1281/BV 1 012810501

1290

screwdrivers for slotted head screws



UNI 10562 ISO 2380 DIN 5265

SxAxL mm	L1 mm	
0,4x2,5x50	146	5 012900003
0,4x2,5x75	171	5 012900006
0,5x3x75	171	10 012900009
0,5x3x100	196	10 012900012
0,5x3x125	221	10 012900015
0,6x3,5x75	171	10 012900018
0,6x3,5x100	196	10 012900021
0,6x3,5x125	221	10 012900024
0,8x4x75	171	10 012900027
0,8x4x100	196	10 012900030
0,8x4x125	221	10 012900033
0,8x4x150	246	10 012900036
1x5,5x100	209	10 012900039
1x5,5x150	259	10 012900042
1x5,5x200	309	5 012900045

Beta

ISO 9001
CERTIFICAZIONE
ZERTIFIZIERUNG

SxAxL mm	L1 mm		
1,2x6,5x100	220	10	012900048
1,2x6,5x150	270	10	012900051
1,2x6,5x200	320	5	012900054
1,2x8x150	282	3	012900057
1,2x8x200	332	3	012900060
1,6x10x150	282	3	012900063
1,6x10x200	332	3	012900066
2x12x250	382	2	012900069

1290/S...

screwdriver set



1290/S5 1 012900305

1290 0,5x3x75-0,8x4x100 -1x5,5x150
1,2x6,5x150 -1,2x8x150 mm

1290/S9 1 012900309

1290 0,4x2,5x75 -0,5x3x125
0,8x4x125-1x5,5x150
1,2x6,5x150 -1,2x8x200
1,6x10x200 mm

1290N 0,8x4x30 -1,2x6,5x30 mm

1290N

screwdrivers for slotted head screws
extra short series



UNI 10562 DIN 5265

SxAxL mm	L1 mm		
0,8x4x30	86,1	5	012900103
1,2x6,5x30	86,1	5	012900106

1290E

screwdrivers for slotted head screws,
with hexagon bolsters



UNI 10562 ISO 2380 DIN 5265

SxAxL mm	L1 mm		
1x5,5x125	234	3	012900153
1,2x6,5x150	270	3	012900156
1,6x10x175	307	2	012900159
2x12x200	332	2	012900162

1292

screwdrivers for cross head
Phillips® screws



UNI/ISO 8764 DIN 5262

PHxDxL mm	L1 mm		
0x3x60	156	10	012920003
0x3x100	196	5	012920006
1x4,5x80	189	10	012920009
1x4,5x120	229	10	012920012
1x4,5x150	259	5	012920015
2x6x100	220	10	012920018
2x6x150	270	10	012920021
2x6x200	320	5	012920023
3x8x150	282	3	012920024
4x10x200	332	3	012920027



1292/S4 1 012920304

PH0x3x60-PH1x4,5x80
PH2x6x100-PH3x8x150 mm

1292N

screwdrivers for cross head
Phillips® screws
extra short series



UNI/ISO 8764 DIN 5262

PHxDxL mm	L1 mm		
1x4,5x30	86,1	5	012920103
2x6x30	86,1	5	012920106

1292E

screwdrivers for cross head
Phillips® screws, with hexagon bolsters



UNI/ISO 8764

PHxDxL mm	L1 mm		
2x6x150	270	3	012920153
3x8x175	307	2	012920156
4x10x200	332	2	012920159

1292L

screwdrivers for cross head
Phillips® screws, long series



UNI/ISO 8764-1

PHxDxL mm	L1 mm		
0x3x300	396	3	012920203
1x4,5x400	509	3	012920206
2x6x400	520	3	012920209

1293/D...

screwdriver set



1293/D6 1 012930401

1290 0,6x3,5x75-1x5,5x150
1,2x6,5x150 mm

1292 PH0x3x60 -PH1x4,5x80
PH2x6x100 mm

1293/D8 1 012930403

1290 0,5x3x75-0,8x4x100
1x5,5x150-1,2x6,5x150
1,2x8x150 mm

1292 PH0x3x60 -PH1x4,5x80
PH2x6x100 mm

1293/D11 1 012930405

1290 0,4x2,5x75 -0,6x3,5x100
0,8x4x125-1x5,5x100-
1,2x6,5x100

1292 1,2x8x150-1,6x10x150 mm
PH0x3x60 -PH1x4,5x120
PH2x6x150-PH3x8x150 mm

1293/D8H 1 012930411

1290 1x5,5x100-1,2x6,5x150 mm
1292 PH0x3x60 -PH1x4,5x80
PH2x6x100 mm

1294 0,5x2,5x60-0,6x3x75
0,8x4x100 mm

1293/D7 1 012930407

1290 0,5x3x100-0,8x4x125
1x5,5x150-1,2x6,5x150 mm
1299PZ PZ0x3x60-PZ1x4,5x80
PZ2x6x100 mm

1293/S...

screwdriver set



1293/S10 1 012930201

1290 0,4x2,5x50 -0,6x3,5x100
1x5,5x100-1,2x6,5x150
1,2x8x150-1,6x10x200 mm
1292 PH0x3x60 -PH1x4,5x80
PH2x6x100-PH3x8x150 mm

1293/S12 1 012930203

1290 0,5x3x75-0,8x4x125
1x5,5x150-1,2x6,5x150
1,2x8x200 mm
1290N 0,8x4x30 mm
1292 PH0x3x60 -PH1x4,5x80
PH2x6x100-PH3x8x150 mm
1292N PH1x4,5x30-PH2x6x30 mm

1293E/S5 1 012930211

1290E 1x5,5x125-1,2x6,5x150
1,6x10x175 mm
1292E PH2x6x150-PH3x8x175 mm

1293/S7 1 012930207

1292 PH0x3x60 -PH1x4,5x80
PH2x6x100 mm
1294 0,5x2,5x60-0,6x3x75
0,8x4x100-1x5x125 mm

1293/S8H 1 012930209

1290 1,2x6,5x150-1,2x8x150 mm
1292 PH0x3x60 -PH1x4,5x80
PH2x6x100 mm
1294 0,5x2,5x60-0,6x3x100
0,8x4x100 mm

1293/S8PZ 1 012930205

1290 0,4x2,5x75 -0,6x3,5x75
1x5,5x100-1,2x6,5x150 mm
1299PZ PZ0x3x60-PZ1x4,5x80
PZ2x6x100-PZ3x8x150 mm

1293ES

hexagon drivers with handles



mm	L mm	L1 mm	
2	100	196	5 012930001
2,5	100	196	5 012930002
3	100	196	5 012930003
4	100	209	5 012930004
5	100	220	5 012930005
6	125	245	5 012930006
8	150	282	2 012930008



1293ES/S7 1 012930057
2-2,5-3-4-5-6-8 mm

1293BP

ball head hexagon drivers with handles



mm	L mm	L1 mm	
2	100	196	5 012930501
2,5	100	196	5 012930502
3	100	196	5 012930503
4	100	209	5 012930506
5	100	220	5 012930509
6	125	245	5 012930512
8	150	282	2 012930515



1293BP/S7 1 012930558
2-2,5-3-4-5-6-8 mm

1294

screwdrivers for headless slotted screws



SxDxL mm	L1 mm	
0,5x2,5x60	156	5 012940003
0,6x3x75	171	5 012940006
0,6x3x100	196	5 012940009
0,8x4x100	196	5 012940012
0,8x4x150	246	5 012940015
1x5x125	234	5 012940018
1x5x150	259	5 012940021
1x5x200	309	5 012940024
1,2x6,5x150	282	5 012940027
1,6x8x150	282	3 012940030



1294/S5 1 012940305
0,5x2,5x60-0,6x3x100
0,8x4x100-1x5x125
1,2x6,5x150 mm

1294L

screwdrivers for headless slotted screws long series

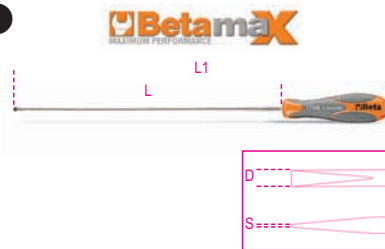

SxDxL mm	L1 mm	
0,5x2,5x200	296	3 012940203
0,6x3x300	396	3 012940206
0,8x4x400	496	3 012940209
1x5x300	409	3 012940212
1x5x400	509	3 012940215
1,2x6,5x400	532	3 012940218

1295

impact screwdriver



L mm
130 1 012950001

1295/C14

impact screwdriver with 14 insets and 1 socket holder

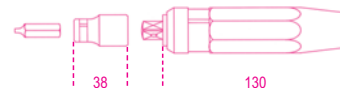

1295/C14 1 012950108

	866LP	1,2x6,5 - 1,6x10 mm
	866PH	PH2 - PH3
	866PZ	PZ2 - PZ3
	866PE	5 - 6 mm
	866TX	T27 - T30 - T40 - T45 - T50 - T55
	895/6	□ 1/2 - ○ 5/16
	1295	■ 1/2

170x100x35 mm - 1300 g

1296/90

angular bit holder (90°)



ISO 1173 E 6.3

1296/90

○ 1/4 - ● 1/4

1 012960001

max. capacity. 30 Nm

1296/C19

1 angular bit holder (90°) with handle and assortment of 18 bits and 1 bit holder



1296/C19

1 012960101

	1296/90	○ 1/4 - ● 1/4
	861LP	0,5x3 - 0,6x4,5 - 0,8x5,5 - 1,2x6,5 mm
	861PE	2 - 3 - 4 - 5 mm
	861PH	PH0 - PH1 - PH2 - PH3
	861RTX	T9 - T10 - T15 - T20 - T25 - T27
	850BM/C	○ 1/4"
	882M1	○ 1/4 - ● 1/4

270x120x45 mm - 980 g

1297TX

drivers for Torx® head screws, with handles



	L mm	L1 mm	
T6	50	146	5 012970006
T7	50	146	5 012970007
T8	60	156	5 012970008
T9	60	169	5 012970009
T10	80	189	5 012970010
T15	80	189	5 012970015
T20	100	209	5 012970020
T25	100	209	5 012970025
T27	115	235	5 012970027
T30	115	235	5 012970030
T40	130	262	2 012970040
T45	130	262	2 012970045



1297TX/S12

T6-T7-T8-T9-T10
T15-T20-T25-T27
T30-T40-T45

1 012970312



1297TX/D6

T10-T15-T20
T25-T27-T30

1 012970409

1298RTX

screwdrivers for Tamper Resistant Torx® head screws, with handles



	L mm	L1 mm	
T9	60	169	5 012980009
T10	80	189	5 012980010
T15	80	189	5 012980015
T20	100	209	5 012980020
T25	100	209	5 012980025
T27	115	235	5 012980027
T30	115	235	5 012980030
T40	130	262	2 012980040



1298RTX/S8

T9-T10-T15-T20
T25-T27-T30-T40

1 012980308

1299PZ

screwdrivers for cross head Pozidriv®-Supadriv® screws



UNI/ISO 8764

PZ	L mm	L1 mm	
0	60	156	5 012990000
1	80	189	5 012990003
2	100	220	5 012990006
3	150	282	2 012990009
4	200	332	2 012990012



1299PZ/S6

1299PZ PZ0-PZ1-PZ2-PZ3
1299N/PZ PZ1-PZ2

1 012990306

1299N/PZ

screwdrivers for cross head Pozidriv®-Supadriv® screws extra short series



UNI/ISO 8764

PZ	L mm	L1 mm	
1	30	86,1	5 012990021
2	30	86,1	5 012990024

1302

double end dolly, round, convex pain head



770 g 1 013020001

1303

curved dolly



1350 g 1 013030001

1304

sole dolly

g
875

1 013040001

1305

toe dolly

g
1190

1 013050001

1305Z

milled toe dolly

g
1065

1 013050002

1306

heel dolly

g
1040

1 013060001

1307

regular dolly

g
1100

1 013070001

1308

egg dolly

g
1100

1 013080001

1309

hatchet dolly

g
460

1 013090001

1310

general purpose dolly

g
1225

1 013100001

1312

anvil dolly

g
1220

1 013120001

1313

buffer dolly

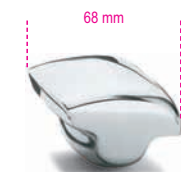
g
990

1 013130001

1314

double end dolly, convex, flat head

g
760

1 013140001

1326

curved angle spoon

g
560

1 013260001

1327

heavy-duty spoon

g
1075

1 013270001

1328

pry and bumping spoon

g
935

1 013280001

1329

double-ended spoon

g
1800

1 013290001

1330

long double-ended spoon



510 mm

g			
2125		1	013300001

1331

bending iron with leather face

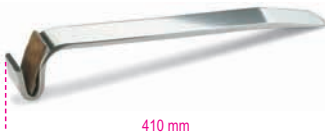

410 mm

g			
1100		1	013310001

1335BM

bumping blade with plastic handle



375 mm

g			
500		5	013350010

1338A - 1338B

adjustable body blade holder with flexible flat blades



360 mm

	1"		
1338A	9	2	013380001
1338B	12	2	013380002

1338

body blade holder for item 1338R



1338		2	013380003
------	--	---	-----------

1338R9 - 1338R12

spare body blades for item 1338A-B



	1"		
1338R9	9	2	013380004
1338R12	12	2	013380005

1342

extra flat chisel with straight cutter



L			
mm	235	5	013420001

1342PM

extra flat chisel with straight cutter with hand guard

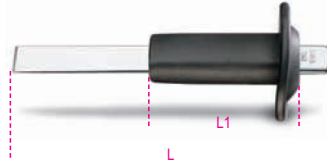

L	L1		
mm	mm	2	013420002
235	118		

1342PMR

spare hand guard for item 1342



1342PMR		1	013420003
---------	--	---	-----------

1343

flat chisel with side cutter



L			
mm	200	5	013430001

1345

hammer with round, convex face and pein, wooden shaft

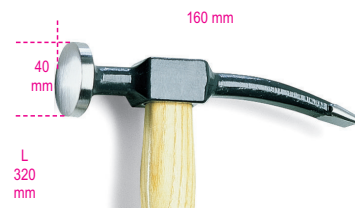

1345		3	013450000
------	--	---	-----------

1345P

hammer with round, flat face and pein, wooden shaft

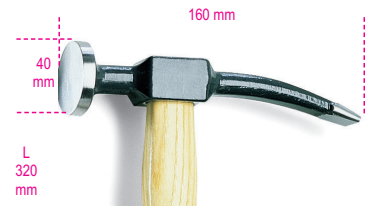

1345P		3	013450001
-------	--	---	-----------

1351

hammer with round, flat face and ball pein, wooden shaft

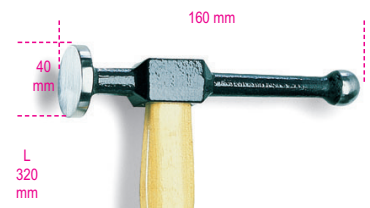

1351		3	013510000
------	--	---	-----------

1353

hammer with round, flat face and point pein, wooden shaft

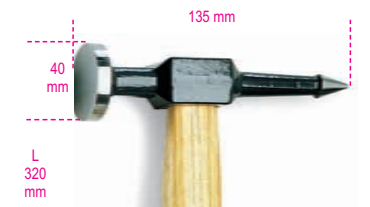

1353		3	013530000
------	--	---	-----------

1357/32 - 1357/40

hammers with round, flat and square faces, wooden shafts

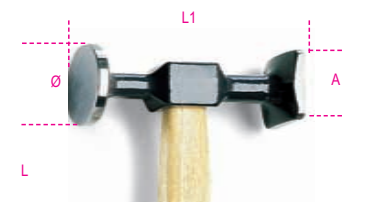

1357/32		3	013570032
---------	--	---	-----------

Ø = 32 mm
A = 25 mm
L1 = 100 mm
L = 280 mm

1357/40		3	013570040
---------	--	---	-----------

Ø = 40 mm
A = 35 mm
L1 = 105 mm
L = 290 mm



1357Z/32 - 1357Z/40

hammers with flat, round, milled face and square, smooth face, wooden shafts

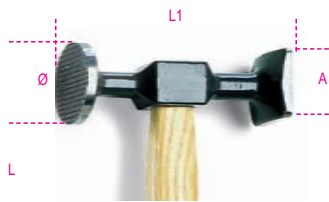

1357Z/32 3 013570132

Ø = 32 mm
A = 25 mm
L1 = 100 mm
L = 280 mm

1357Z/40 3 013570140

Ø = 40 mm
A = 35 mm
L1 = 105 mm
L = 290 mm

1359T

hammer with round, flat face and horizontal pein, wooden shaft

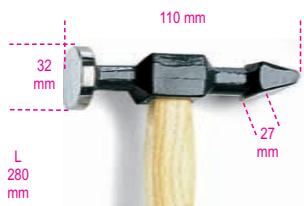

1359T 3 013590001

1369/C11X

assortment of 11 tools



1369/C11X 1 013690023



470x340x70 mm - 15,2 kg

1369/8

assortment of 8 tools for vehicle glass windows



1369/8 1 013690015

1370

engineer's hammers, wooden shaft



UNI 7778 DIN 1041

g	L1 mm	L mm	
100	82	260	5 013700051
200	95	280	5 013700052
300	105	300	5 013700053
400	112	310	5 013700054
500	118	320	5 013700055
600	122	330	5 013700056
800	130	350	4 013700058
1000	135	360	4 013700060
1500	145	380	2 013700065
2000	155	400	1 013700070



1370/MR...

spare shafts for item 1370



Item	Quantity	Code
1370/MR100 1370/100	4	013700081
1370/MR200 1370/200	4	013700082
1370/MR300 1370/300	4	013700083
1370/MR400 1370/400	4	013700084
1370/MR500 1370/500	4	013700085
1370/MR600 1370/600	4	013700086
1370/MR800 1370/800	4	013700088
1370/MR1000 1370/1000	4	013700090
1370/MR1500 1370/1500	4	013700095
1370/MR2000 1370/2000	4	013700100

1370T

mechanic's hammers
fibre shafts



g	L1 mm	L mm	
200	95	280	5 013700620
300	105	300	5 013700630
500	118	320	5 013700650
800	130	350	4 013700680
1000	135	360	4 013700700
1500	145	365	2 013700750

1370F

riveting hammers, wooden shaft



NFE 71.014

A mm	L1 mm	L mm	g	
24	77	260	279	2 013700424
26	80	260	312	2 013700426
28	86	280	400	2 013700428
30	92	280	450	2 013700430
32	100	300	552	2 013700432
36	104	300	717	2 013700436
40	110	330	1100	2 013700440
42	116	330	1150	2 013700442
50	138	380	1800	2 013700450
60	160	380	2600	2 013700460

1370F/MR...

spare shafts for item 1370F



Item	QTY	Code
1370F/MR24 1370F/24-26	2	013700474
1370F/MR28 1370F/28-30	2	013700478
1370F/MR32 1370F/32-36	2	013700482
1370F/MR40 1370F/40-42	2	013700490
1370F/MR50 1370F/50	2	013700495
1370F/MR60 1370F/60	2	013700496

1370FT

riveting hammers, fibre shafts



A mm	L1 mm	L mm	g	QTY	Code
28	86	280	530	1	013700528
30	92	280	625	1	013700530
32	100	300	750	1	013700532
36	104	300	930	1	013700536
40	110	330	1150	1	013700540
42	116	330	1250	1	013700542
50	138	380	2100	1	013700550
60	160	380	2750	1	013700560

1374F

carpenter's hammers, wooden shaft



NF E 71.012

A mm	L1 mm	L mm	g	QTY	Code
16	80	250	176	2	013740416
20	86	270	250	2	013740420
22	92	290	335	2	013740422
26	103	290	425	2	013740426
28	108	310	513	2	013740428
30	117	310	576	2	013740430

1374F/MR...

spare shafts for item 1374F



Item	QTY	Code
1374F/MR16 1374F/16	2	013740456
1374F/MR20 1374F/20	2	013740460
1374F/MR22 1374F/22-26	2	013740462
1374F/MR28 1374F/28	2	013740468
1374F/MR30 1374F/30	2	013740470

1375

claw hammer, wooden shaft



g	L1 mm	L mm	QTY	Code
300	95	300	3	013750000

1375/MR

spare shafts for item 1375



1375/MR	2	013750003
---------	---	-----------

1375A

claw hammers, plastic shafts



oz	g	QTY	Code
16	450	3	013750016
20	570	3	013750020

1375B

claw hammers, steel shafts



oz	g	QTY	Code
16	450	3	013750026
20	570	3	013750030

1376X

claw hammers with square peins, magnets and nail holders wooden shaft



g	L1 mm	L mm	QTY	Code
250	125	450	3	013760125
300	130	450	3	013760130
400	132	450	3	013760140

1376X/MR

spare shaft for item 1376X



1376X/MR	2	013760161
----------	---	-----------

1376XT

claw hammers with square peins, magnets and nail holders plastic shaft



g	L1 mm	L mm	QTY	Code
250	125	500	3	013760525
300	130	500	3	013760530
400	132	500	3	013760540

1376XT/MR

spare shaft for item 1376XT



1376XT/MR	2	013760585
-----------	---	-----------

1377

ball pein hammers, round heads, for coppersmiths and tinsmiths, wooden shafts



g	oz	L1 mm	L mm	QTY	Code
340	12	95	330	2	013770134
450	16	102	350	2	013770145
570	20	110	350	2	013770157
680	24	116	360	2	013770168
900	32	120	380	2	013770190

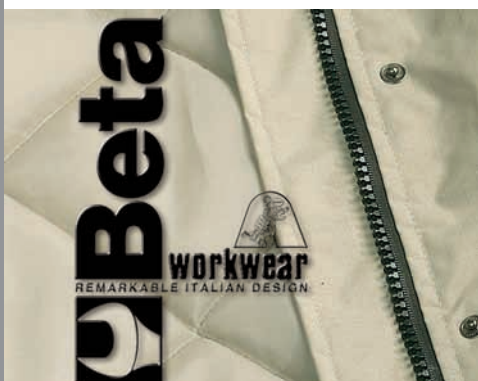

1377/MR...

spare shafts for item 1377



1377/MR340 1377/340	2	013770234
1377/MR 1377/450	2	013770245
1377/MR570 1377/570	2	013770257
1377/MR 1377/680	2	013770268
1377/MR900 1377/900	2	013770290

1378

joiner's hammers, round heads and peins, wooden shafts



HICKORY

g	oz	L1 mm	L mm		
340	12	100	330	2	013780134
570	20	115	350	2	013780157

1378/MR...

spare shafts for item 1378



1378/MR340 1378/340	2	013780234
1378/MR570 1378/570	2	013780257

1379F

electrician's hammers, wooden shafts



HICKORY

NF E 71.011

A mm	L1 mm	L mm	g		
16	126	250	210	2	013790416
18	135	250	260	2	013790418
20	142	260	320	2	013790420

1379F/MR...

spare shafts for item 1379F



1379F/MR16 1379F/16-18	2	013790426
1379F/MR20 1379F/20	2	013790430

1380

lump hammers, wooden shafts



HICKORY

UNI 7777 DIN 6475

g	L1 mm	L mm		
800	90	260	2	013800208
1000	95	260	2	013800210
1250	100	260	2	013800212
1500	110	280	2	013800215
2000	120	300	2	013800220

1380/MR...

spare shafts for item 1380



1380/MR800 1380/800-1000-1250	2	013800238
1380/MR1500 1380/1500	2	013800245
1380/MR2000 1380/2000	2	013800250

1380S

mason club hammers with security collars wooden shafts



g	L1 mm	L mm		
800	90	260	2	013800400
1000	95	260	2	013800405
1250	100	260	2	013800410
1500	110	260	2	013800415

1380S/MR...

spare shafts for item 1380S



1380S/MR800 1380S/800-1000-1250	2	013800417
1380S/MR1500 1380S/1500	2	013800419

1380T

mason club hammers, plastic shafts



g	L1 mm	L mm		
800	85	260	2	013800308
1000	100	260	2	013800310
1250	110	260	2	013800312
1500	120	260	2	013800315

1381

sledge hammers, Hickory shafts



HICKORY

g	L1 mm	L mm		
3000	142	800	1	013810030
4000	152	900	1	013810040
5000	162	900	1	013810050
8000*	185	900	1	013810080

* = ash shaft

1381/MR...

spare shafts for item 1381



1381/MR3-4 1381/3000-4000	2	013810730
1381/MR5 1381/5000	2	013810750
1381/MR8 1381/8000	2	013810780

1385N

copper head hammers, wooden shafts



g	L1 mm	L mm		
400	65	300	2	013850204
600	95	300	2	013850206
800	110	320	2	013850208
1000	102	350	2	013850210
1500	116	360	2	013850215
2000	121	380	2	013850220

1385N/MR

spare shafts for item 1385N



1385N/MR	2	013850264
1385N/MR 400-600		
1385N/MR	2	013850268
1385N/MR 800		
1385N/MR	2	013850270
1385N/MR 1000		
1385N/MR	1	013850275
1385N/MR 1500		
1385N/MR	1	013850280
1385N/MR 2000		

1390

soft face hammers, wooden shafts



UNI 7784

D mm	L1 mm	L mm	g		
22	70	260	135	5	013900022
28	85	280	230	5	013900028
35	95	310	365	5	013900035
45	107	320	700	4	013900045
60	128	380	1450	2	013900060

1390/MR...

spare shafts for item 1390



1390/MR22	2	013900222
1390/22		
1390/MR28	2	013900228
1390/28		
1390/MR35	2	013900235
1390/35		
1390/MR45	2	013900245
1390/45		
1390/MR60	2	013900260
1390/60		

1390R

spare faces for item 1390



D mm		
22	4	013900122
28	4	013900128
35	4	013900135
45	4	013900145
60	4	013900160

1391

dead-blow hammers, entirely covered with rubber



D mm	L1 mm	L mm	g		
35	90	280	444	2	013910135
50	105	320	915	2	013910150
55	110	355	1000	2	013910155
65	130	380	1450	2	013910165

1391A

dead-blow hammers for tile workers, entirely covered with rubber



g	L1 mm	L mm		
500	100	290	2	013910205
1000	120	300	2	013910210

1392

dead-blow hammers, with interchangeable plastic faces, steel shafts



D mm	L1 mm	L mm	g		
30	105	300	510	2	013920030
35	115	305	670	2	013920035
40	125	310	800	2	013920040
50	135	325	1000	2	013920050

1392R

spare faces for item 1392



D mm		
30	4	013920230
35	4	013920235
40	4	013920240
50	4	013920250

1393

hard rubber head hammers



D mm	L1 mm	L mm	g		
50	90	315	285	3	013930050
60	110	340	460	3	013930060
70	130	370	740	2	013930070

1410/M

spring pulling hook wrench



∅ mm		
3,5	2	014100051

1428

pullers for damaged nuts with square drive



M mm	□	L mm		
8	3/8	36	3	014280008
10	3/8	36	3	014280010
11	3/8	36	2	014280011
12	3/8	36	2	014280012
13	3/8	36	2	014280013
14	3/8	36	2	014280014
15	1/2	38	2	014280015
16	1/2	38	2	014280016
17	1/2	38	2	014280017
18	1/2	38	2	014280018
19	1/2	38	2	014280019



1428/SB11	1	014280111
8-10-11-12-13-14		
15-16-17-18-19		

1428L

socket pullers, long series, for damaged right-hand nuts, with square drive



mm	1	014280217
17	1	014280217
19	1	014280219
21	1	014280221



1428L/B3	1	014280303
17-19-21 mm	1	014280303

1429

pullers for damaged screws and stud bolts with square drive



mm	□	L mm	3	014290002
2	3/8	60	3	014290002
3	3/8	60	3	014290003
4	3/8	60	3	014290004
5	3/8	60	2	014290005
6	3/8	60	2	014290006
8	1/2	70	2	014290008
10	1/2	70	2	014290010



1429/SB7	1	014290107
2-3-4-5-6-8-10	1	014290107

1430/...

tapered extractors for broken screws and studs made from hardened and tempered steel

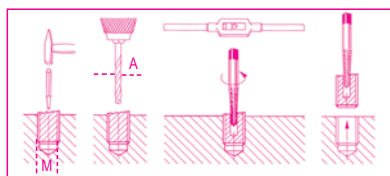

1430/1	M	A mm	10	014300006
1430/2	3÷6	2,5	10	014300006
1430/3	6÷8	3,0	10	014300008
1430/4	8÷11	4,5	10	014300011
1430/5	11÷14	6,0	10	014300014
1430/6	14÷18	8,0	10	014300018
1430/7	18÷24	11,0	5	014300024
1430/8	24÷33	14,0	5	014300033
1430/8	33÷50	21,0	5	014300050



1430/S5	1	014300105
1430/1-1430/2-1430/3	1	014300105
1430/4-1430/5	1	014300106
1430/S6	1	014300106
1430/1-1430/2-1430/3	1	014300108
1430/4-1430/5-1430/6	1	014300108
1430/S8	1	014300108
1430/1-1430/2-1430/3	1	014300108
1430/4-1430/5-1430/6	1	014300108
1430/7-1430/8	1	014300108

1434

roller stud extractors with 1/2" square drives

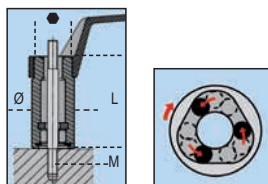

M	∅ mm	L mm	● mm	4	014340106
6	24	65	21	4	014340106
7	24	65	21	4	014340107
8	24	65	21	4	014340108
9	29	75	22	4	014340109
10	29	75	22	4	014340110
10,5	29	75	22	4	014340111
12	29	75	22	4	014340112
14	36	75	27	4	014340114
16	36	75	27	4	014340116

1434/C4

set of extractors



1434/C4	1	014340140
M6 - M8 - M10 - M12	1	014340140

170x100x35 mm - 1,1 kg

1434/C7

set of extractors



1434/C7	1	014340170
M6 - M7 - M8 - M9	1	014340170
M10 - M10,5 - M12	1	014340170

250x100x35 mm - 1,7 kg

1435

set of extractors

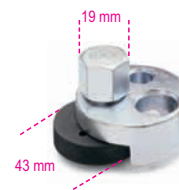

∅ mm	1	014350001
4÷20	1	014350001

1435R

spare wheel for item 1435



1435R	1	014350010
1435R	1	014350010

1435/1

eccentric stud extractor

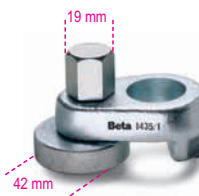

∅ mm	1	014350002
19÷26	1	014350002

1435/1R

spare wheel for item 1435/1

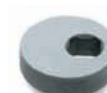

1435/1R	1	014350011
1435/1R	1	014350011

1438

universal clutch aligner complete with 3 expansion mandrels



1438 1 014380001

1438R

spare expansion mandrels for item 1438



Ø mm		
14÷18	5	014380101
18÷21	5	014380102
22÷25	5	014380103

1439/K7

angular screwdriver (90°), long series, with blades, in case

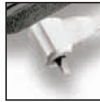

Case contents:

- Angular screwdriver
- 1 slotted screw head
- 1 1/4" bit head
- Special blade head
- 7 special blades

1439/K7 1 014390101

500x120x60 mm 825 g

1440/...

piston ring compressors



Ø mm		
1440/0	40÷75	1 014400000
1440/1	57÷125	1 014400010
1440/1A	57÷125	1 014400011
1440/2	90÷175	1 014400020
1440/2A	90÷175	1 014400021
1440/3	90÷175	1 014400030

1445/1 - 1445/2

piston ring expanders



	Ø mm	
1445/1	50÷100	1 014450001
1445/2	90÷150	1 014450002

1450GC

valve spring compressor with straight and offset jaws

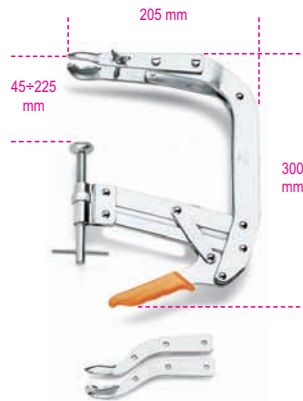

1450GC 1 014500005

1452K

valve spring compressor, with three flanges

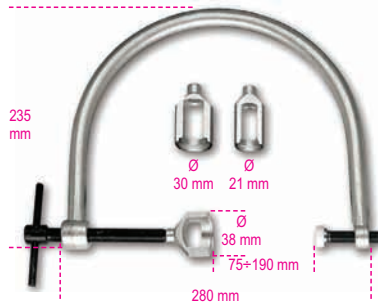

1452K 1 014520100

1454

engine head support

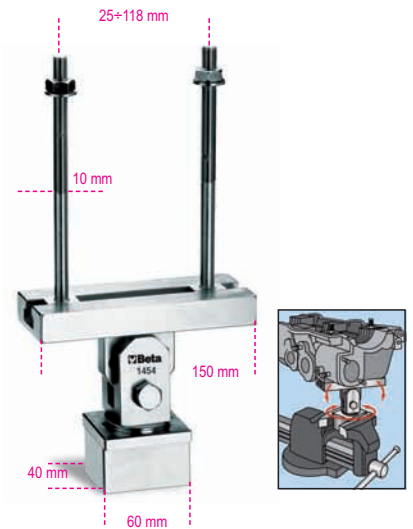

1454 1 014540001

1455SVP

pneumatic valve grinder

• Pressure: 6 bars

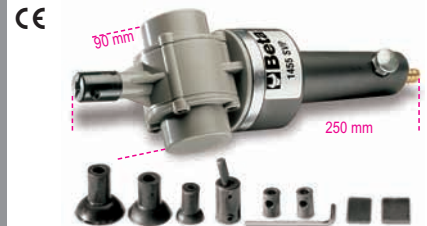

1455SVP 1 014550001

1455SVP/R...

spare parts for item 1455SVP



1455SVP/R1 5 014550501

1455SVP/R2 5 014550502

1455SVP/R3 5 014550503

1458

external butt-ended circlip pliers



DIN 5417

Ø mm 30÷100 3 014580001



1460F

valve seat removing tool



270 mm

1460F 1 014600010

1461PMS

top dead centre (TDC) finder



M	Ø	L
mm	mm	mm
14x1,25	19,0	240

1 014610500

1461BF

timing blocks for Fiat, Alfa Romeo and Lancia engines



1461BF/N	1 014610501
1461BF/AG	1 014610502
1461BF/R	1 014610503
1461BF/B	1 014610504
1461BF/O	1 014610505
1461BF/V	1 014610506
1461BF/GR	1 014610507
1461BF/S	1 014610508
1461BF/VI	1 014610509
1461BF/BR	1 014610510
1461BF/T	1 014610511
1461BF/A	1 014610512

1461/C1

timing devices for Alfa Romeo, Fiat and Lancia engines



1461/C1 1 014610010
420x350x35 mm - 6,0 kg

1461/C2

timing devices for Fiat Bravo, Brava, Multipla and Stilo 1.6 16V engines

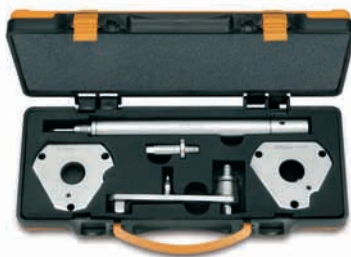

1461/C2 1 014610020
380x305x40 mm - 2,5 kg

1461/C3

timing devices for Fiat Punto-Lancia Y, 1.2 16V - 1.6 16V engines



1461/C3 1 014610030
380x305x40 mm - 2,0 kg

1461/C4

timing devices for Fiat-Alfa diesel TDC 1st cylinder engines

Fiat 1697D - 1929D - 1910D - TD - 1910 JTD - 2387 TD



1461/C4 1 014610040
250x75x40 mm - 400 g

1461/C5

timing devices for Fiat MultiJet diesel and Opel CDTI engines

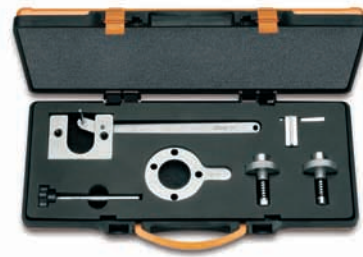

1461/C5 1 014610050
450x250x45 mm - 2,6 kg

1461/C6

timing devices for Citroen and Peugeot engines



1461/C6 1 014610060
420x350x35 mm - 3,5 kg

1461/C7

timing devices for Renault 1.4 16V - 1.6 16V - diesel engines



1461/C7 1 014610070
420x350x35 mm - 4,5 kg

1461/C8

timing devices for Ford petrol and diesel engines



1461/C8 1 014610080

450x250x45 mm - 2,8 kg

1461/C9

timing devices for Opel 1.0 12V - 1.2 16V - 1.4 16V engines



1461/C9 1 014610090

380x305x40 mm - 1,0 kg

1461/C10

timing devices for Audi, Seat, Skoda and Volkswagen engines



1461/C10 1 014610100

420x350x35 mm - 4,1 kg

1461/C11

timing devices for Renault 1.5 - 1.9 DCI engines

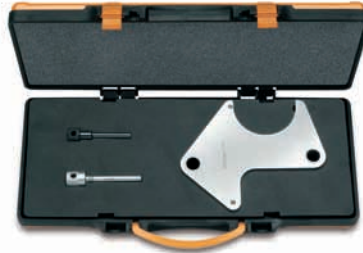

1461/C11 1 014610110

450x250x45 mm - 2,3 kg

1461/C12

timing devices for Fiat 1.9 JTD 16V Multijet engines



1461/C12 1 014610120

380x305x40 mm - 1,8 kg

1461/C14

timing devices for BMW VANOS and Valvetronic engines



1461/C14 1 014610140

450x250x45 mm - 4,0 kg

1461/C15

timing devices for BMW Valvetronic engines (for use with item 1461/C14)



1461/C15 1 014610150

420x350x35 mm - 4,0 kg

1461/C16

timing devices for BMW 2.0-3.0 DIESEL engines, complete with pump puller



1461/C16 1 014610160

380x305x40 mm - 4,3 kg

1461/C17

timing devices for Volkswagen, Seat and Skoda 1.2 6-12V engines



1461/C17 1 014610170

250x190x100 mm - 1,5 kg

 **Beta**



1461/C18

timing devices for Volkswagen, Audi, Skoda
1.4 - 1.6 FSI engines



1461/C18 1 014610180
380x305x40 mm - 1 kg

1461/C19

timing devices for Ford Duratorq 2.0-2.2-2.4
DIESEL engines



1461/C19 1 014610190
380x305x40 mm - 1,5 kg

1461R6/K3

timing devices for
Peugeot and Citroën engines



1461R6/K3 1 014610601

1463/KIT

valve timing system pulley locking kit



1463/KIT 1 014630001
280x140x75 mm - 1,2 kg

1467

brake fluid extractor



Pressure: min 5 bar, max 11.5 bar

1467 1,5 1 014670001

1467E

electronic instrument for brake fluid
replacement



CE

- Pump, adjustable up to 5.8 bar
- For use on ABS ETS ESP systems
- Fitted with an adjustable locking device, triggered in case of brake fluid depletion in filling container
- No use of compressed air
- Power supply: 220/230 V with protection fuse
- Supplied in a case with cap adapters (ø 45 mm, 79 mm + 1 universal)
- Tube length: 3.5 m; cable length: 5.5 m
- Supplied with a tank, max. capacity 5 l

The pressure used by the instrument is defined as adjustable and button pressure.

1467E 1 014670021

1467/KE

set of cap adapters
in plastic case
(included in item 1467 E)



1467/KE 1 014670022

1467E/FR

waste brake fluid container
(supplied with item 1467E)



1467E/FR 1 014670024

1467E/RT

5 litre tank for item 1467 E

(included in item 1467 E)



1467E/RT 1 014670023

1468/F...

rotary brush kit for cleaning wheel hubs

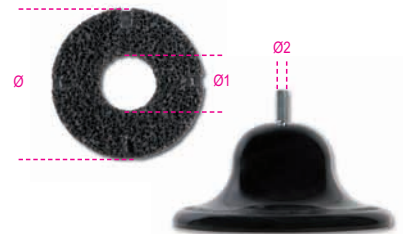

	ø mm	ø1 mm	ø2 mm	N °	
1468/F30	40-53	14	8	12	1 014680030
1468/F160	160	60	10	2	1 014680160
1468/F200	200	85	10	1	1 014680200

1468/P

sanding disks



	ø mm	ø1 mm	N °	
1468 40/P30	40	14	6	1 014680031
1468 50/P30	53	14	6	1 014680032
1468/P160	160	60	1	1 014680161
1468/P200	200	85	1	1 014680201

1468N

valve depressors for disc removal

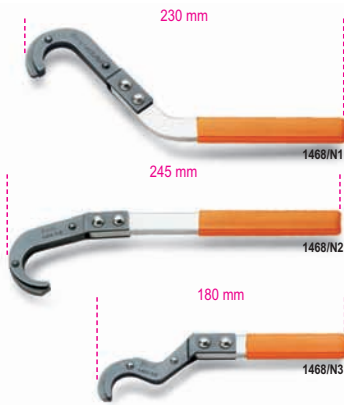

1468N/1	1	014680011
1468N/2	1	014680012
1468N/3	1	014680013

1469

adjustable self-locking pliers for brake hoses



1469	1	014690001
------	---	-----------

1469C

brake hose countersink, in case



SAE J514
SAE J1065
DIN 74234

3/16" - 4,75 mm	1	014690100
-----------------	---	-----------

350x300x105mm - 6 Kg

1469C-R

die and insert kit for brake pipe flaring



SAE J514
SAE J1065
DIN 74234

	∅	
1469C-R 3/16	3/16"	1 014690501
1469C-R 4,75	4,75 mm	1 014690502
1469C-R 6	6 mm	1 014690503
1469C-R 8	8 mm	1 014690504
1469C-R 10	10 mm	1 014690505
1469C-R 12	12 mm	1 014690506

1469D

digital brake fluid tester in plastic case



- Allows DOT braking fluids to be tested
- Measures brake fluid boiling point
- Automatic test, with °C/°F scale switching
- Accuracy: 100 + 180 °C +/- 3% > 180 °C +/- 5%
- Power supply: 12 volts (vehicle battery)

1469D	1	014690110
-------	---	-----------

310x230x100 mm - 1,1 kg

1470

drum brake spring pliers



L mm	
210	1 014700001
330	1 014700002
540	1 014700010

1471

drum brake spring pliers



L mm	330	1	014710001
------	-----	---	-----------

1471A

handbrake wire pliers



A max mm	B mm	
45	5	2 014710010

1471U

set of tools for rotating and pushing back right and left brake pistons



1471U	1	014710050
-------	---	-----------

410x300x100 mm - 4,4 kg

1471PN/50

pneumatic tool for pushing back and rotating right and left disc brake pistons with accessories



1471PN/50	1	014710061
-----------	---	-----------

350x310x85 mm - 3,2 kg

1471M/50

pneumatic tool for pushing back and rotating right and left disc brake pistons with accessories

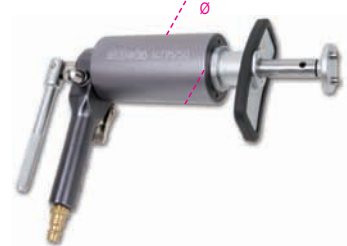

∅ mm	Kg	Bar	
50	150	5÷8	1 014710069

1471M/P

worn pad and TRW-Mégane caliper adapters



1471M/P	1	014710080
---------	---	-----------

1471M/W50

VW Passat handbrake adapter (≥ 2005)

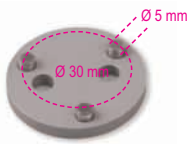

1471M/W50

1 014710079

1471PN/B1

Ford handbrake adapter

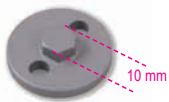

1471PN/B1

1 014710081

1471PN/B2

Daily handbrake adapter



1471PN/B2

1 014710082

1471PN/B3

BMW handbrake adapter



1471PN/B3

1 014710083

1471PN/B4

BMW handbrake adapter



1471PN/B4

1 014710084

1471PN/B5

Mini/ BMW handbrake adapter



1471PN/B5

1 014710085

1471CF

pentagon hand sockets for brake caliper nuts



mm

14

1 014710314

19

1 014710319

1471CM

pentagon socket driver for brake caliper screws



mm

10

1 014710360

1471D

tool for pushing back disc brake pistons with closed callipers

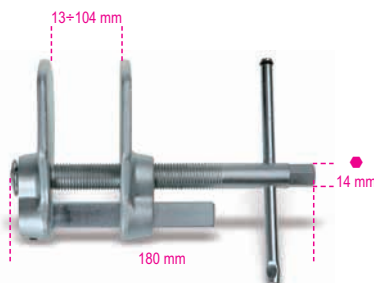

1471D

1 014710300

1471/S4

set of 4 pliers for locking drum brake pistons



1471/S4

1 014710250

1472

hose clamp pliers

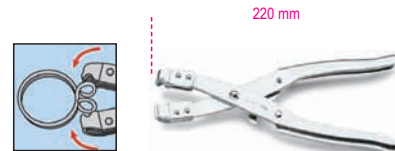

1472

1 014720001

1472AU

automatic hose clamp pliers



Ø

mm

18÷53

1 014720100

1472AU/P

automatic hose ring pliers with extension



L = 630 mm

Ø

mm

18÷54

1 014720105

1472FS

CLIC® collar pliers



1472FS

1 014720110

1473

OETIKER® collar pliers



1473

1 014730001

1473A

slotholder pliers for OETIKER® collars

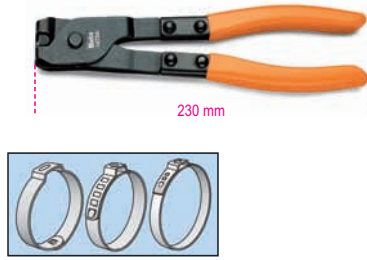

1473A 1 014730010

1474

spark-plug pliers



∅ min mm 12,5 2 014740001

1474A

spark-plug pliers, curved nose, 50°

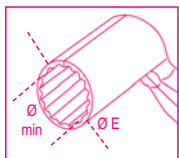
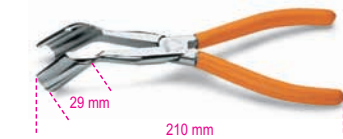

∅ min mm 16 ∅ E mm 21 2 014740005

1474B

spark-plug pliers, curved nose, 25°

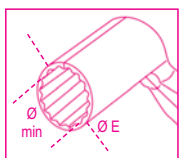

∅ min mm 16 ∅ E mm 20 2 014740008

1474L

spark-plug pliers, curved long nose, 15°

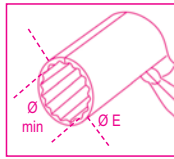

∅ min mm 14 ∅ E mm 20 2 014740010

1474DL

spark-plug pliers, long nose, double layer PVC coated handles



1474DL 1 014740015

1475L

extra long needle nose pliers, bright chrome-plated, double layer PVC coated gun handles

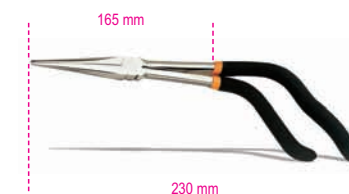

1475L 1 014750005

1475U

combination pliers, bright chrome-plated, double layer PVC coated gun handles

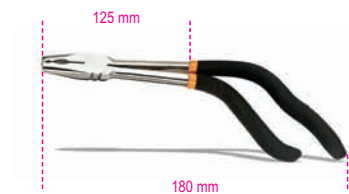

1475U 1 014750010

1476

adjustable self-locking pliers for exhaust pipe cutting

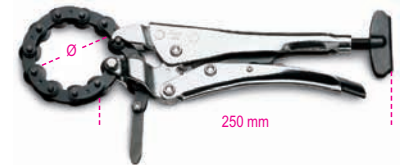

∅ min mm 19 ∅ max mm 75 1 014760001

1476/RC

spare chain for item 1476



1476/RC 1 014760010

1476A

pliers for exhaust pipe cutting



∅ min mm 30 ∅ max mm 95 1 014760005

1476A/RC

spare chain for item 1476A



1476A/RC 1 014760015

1476B/1

exhaust manifold spring puller

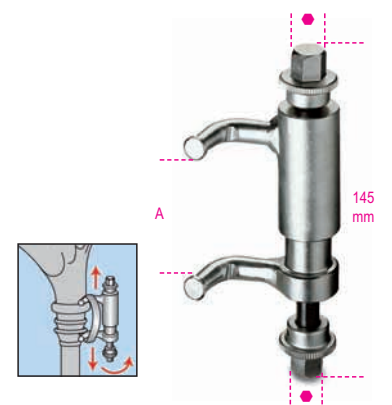

A ∅ min+max mm 40+70 ∅ mm 13 1 014760020

1476C/1 - 1476C/2

exhaust pipe expanders

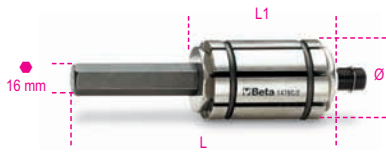

1476C/1 1 014760101

Ø 28÷42 mm

L = 131 mm

L1 = 51 mm

1476C/2 1 014760105

Ø 38÷62 mm

L = 164 mm

L1 = 64 mm

1477

ring wrenches for belt tightening nuts



13 1 014770013

15 1 014770015

1477K/7

kit with bent reversible ratcheting wrench and bits



- 2 TORX T40-T45 bits
- 1 XZN 10 bit
- 1 hexagon bit, 8 mm
- 3 bi-hex bits, 10-12-13 mm

1477K/7 250 1 014770051

1478

pin removing pliers



1478 1 014780001

1479

trim pin remover

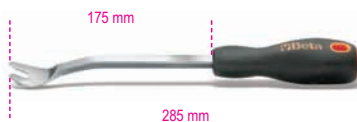

1479 4 014790001

1479TF

trim pin remover Teflon®-coated blade



1479TF 2 014790005

1479RB/1

straight putty knife scraper



1479RB/1 1 014790315

1479RB/2

bent putty knife scraper



1479RB/2 1 014790320

1479RB/3

flat putty knife scraper



1479RB/3 1 014790310

1479U/13

set of 3 putty knife scrapers



1479U/13 2 014790010

1479U/32

trim pin remover, stainless steel blade



1479U/32 2 014790015

1479N/S5

kit of 5 nylon trim pin removers



1479N/S5 1 014790251

1481PL/A

plastic hose pliers



8÷15 3 014810110

1481PL/B

plastic hose pliers



15÷25 3 014810120

1481PL/C

plastic hose pliers



25÷45 3 014810130

1481PL/S3

set of 3 plastic hose pliers



1481PL/B



1481PL/C

1481PL/S3

1481PL-A Ø 8÷15 mm
1481PL-B Ø 15÷25 mm
1481PL-C Ø 25÷45 mm

1 014810200

1482/8 - 1482/10

quick coupler pliers for fuel pipes

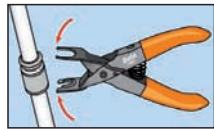

	Ø mm	
1482/8	8	2 014820008
1482/10	10	2 014820010

1482A

quick coupler pliers for fuel pipes

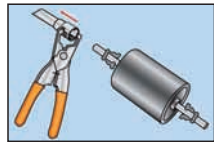

1482A 2 014820020

1482G/...

adjustable wrenches
for fuel tank floating ring nuts

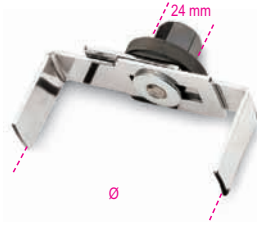

	Ø mm	
1482G/1	85÷120	1 014820025
1482G/2	118÷165	1 014820030
1482G/3	160÷205	1 014820035

1485/KIT

kit for controlling cam belt tension



1485/KIT 1 014850100

≡ 230x140x75 mm - 580 g

1485R

universal tool for rotating camshaft pulleys
made from forged steel
with 2 pairs of tips



Ø mm	Ø1 mm	L mm	
30÷120	10 - 17	500	1 014850025

1485R/P10

pairs of inserts



1485R/P10 1 014850035

1485R/P17

pairs of inserts



1485R/P17 1 014850038

1486T

pulley wrench, V-shaped



Ø
mm
40÷140 1 014860001

1486M

pulley wrench



Ø
mm
40÷140 1 014860002

1488 - 1488L

oil-filter wrench with double chain



	Ø mm	
1488	60÷110	1 014880001
1488L	60÷160	1 014880050

1488/1

oil-filter wrench
with thin double chain

12"

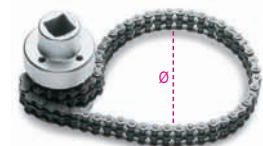

Ø
mm
60÷110 1 014880010

Beta
SHOP
in Shop

1489/33

alternator pulley free wheel wrench



1489/33 33 3 014890010

1489/33P

alternator pulley free wheel wrench, for new Bosch FIAT Grande Punto alternators

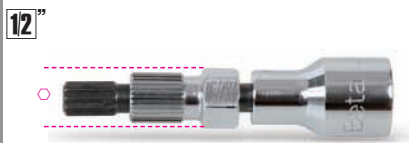

10 15 31 1 014890015

1489/Y

alternator pulley free wheel wrench, for Nippondenso alternators



32 3 014890040

1489R

alternator pulley free wheel wrench



1489R 1 014890020

1490/1 - 1490/2

strap wrenches for oil filters

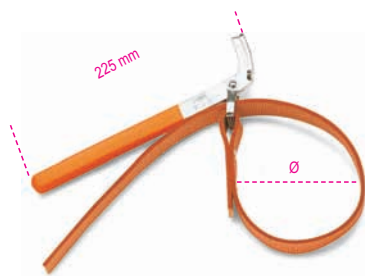

1490/1 160 1 014900001
1490/2 240 1 014900002

1491

adjustable oil filter wrench



65-110 2 014910001

1491R

spare metal band for item 1491



1491R 10 014910010

1491C

adjustable oil filter pliers



60-100 300 1 014910030

1492/1 - 1492/2

adjustable oil filter wrenches



1492/1 60-80 1 014920001
1492/2 80-110 1 014920002

1493/A

oil-filter wrench

8 sides

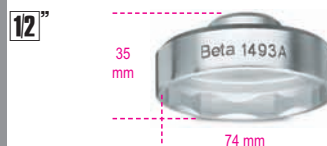

1493/A 1 014930001

1493/B

oil-filter wrench

10 sides



1493/B 1 014930005

1493/C

oil-filter wrench

10 sides

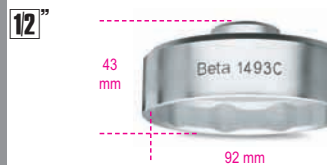

1493/C 1 014930010

1493/D

oil-filter wrench

15 sides



1493/D 1 014930015

1493/E - F - G

oil filter wrenches

N= number of sides



1493/E 65 14 2 014930020
1493/F 74 15 2 014930025
1493/G 90 15 2 014930030



1493/L - M - P - R

Purflux® oil-filter wrenches

N= number of sides

12"

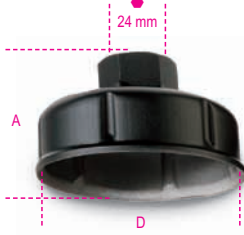

	A mm	D mm	N		
1493/L	44	66	6	2	014930040
1493/M	45	76	6	1	014930050
1493/P	50	86	9	1	014930065
1493/R	50	96	9	1	014930070

1493T

adjustable oil-filter wrench,
three arms



Ø mm		
60÷120	1	014930075

1493/S-U

self-adjusting oil filter wrench with 3 arms,
for right and left hand tightening

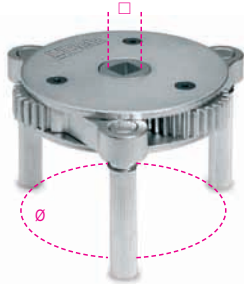

	□	Ø mm		
1493/S	3/8-1/2	80-115	1	014930074
1493/U	1/2	105-165	1	014930076

1493J

wrench for Fiat MultiJet, Lancia,
Opel CDTI and Suzuki DDiS
diesel oil filters

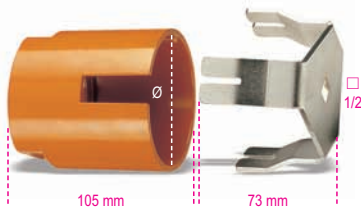

Ø mm		
90	1	014930080

1493Z/1 - 2 - 3

self-locking oil filter wrenches

12"



	Ø mm		
1493Z/1	60÷80	1	014930090
1493Z/2	80÷100	1	014930095
1493Z/3	100÷125	1	014930100

1494

square oil drain plug socket

12"



■ mm		
10	1	014940280

1494E

male hexagon oil drain plug sockets

12"



○ mm		
8	1	014940208
9	1	014940209
10	1	014940210
11	1	014940211
12	1	014940212
14	1	014940214
17	1	014940217

1494Q

male square oil drain plug sockets

12"



○ mm		
8	1	014940258
9,5	1	014940259
12	1	014940262
13	1	014940263

1494T

male triangular oil drain plug socket

12"



Δ mm		
9,5	1	014940289

1494XZN

male oil drain plug socket with XZN® profile

12"



M		
16	1	014940296

1494/C14A

assortment of 14 oil change tools

12"



1494/C14A		
	1	014940150

- 1494E 8-9-10-11-12-14-17
- 1494Q 8-9,5(3/8")-12-13
- 1494 10
- △ 1494T 9,5(3/8")
- 1494XZN M16

380x305x40 mm - 1,7 kg

1496/A

oil plug wrench



□ 10 x ■ 10 mm		
	3	014960001

1496/B

oil plug wrench



280 mm

□ 10 x ■ 8 mm

3 014960005

1496/C

oil plug wrench



220 mm

■ 8 x ■ 10 mm

3 014960010

1496/D

oil plug wrench



215 mm

● 10 x ● 12 mm

3 014960015

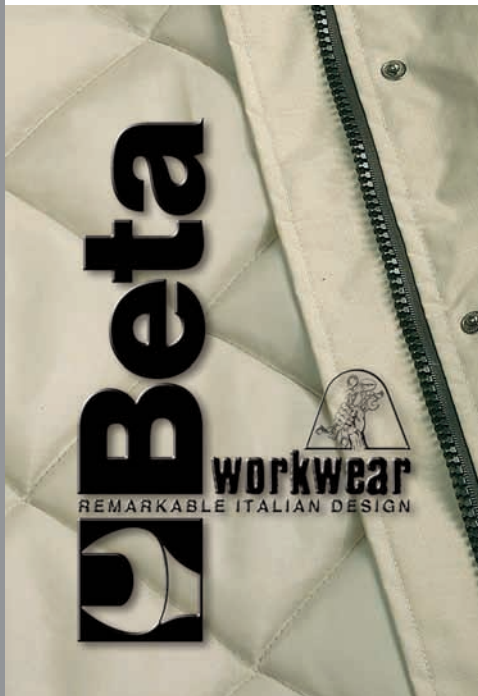

1498

voltage tester

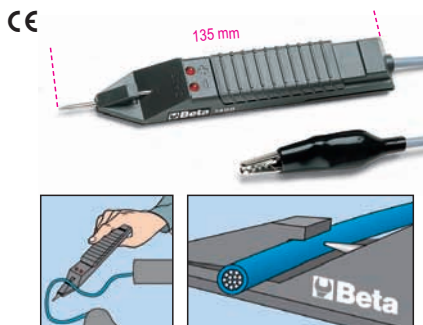

135 mm

3=48V

2 014980100

1498A/12

car starter, 12 V



TECHNICAL DATA

- Pickup current 2200 A
- Useful recharging cycles 400
- Sealed lead acid battery, solid electrolyte (AGM) type

1498A/12

1 014980200

1498A/24

car and commercial vehicle starter, 12-24 V



TECHNICAL DATA

- Pickup current 3400 A (12 V), 1700 A (24 V)
- Useful recharging cycles 400
- Sealed lead acid battery, solid electrolyte (AGM) type

1498A/24

1 014980210

1498CB/30

electronic car/motorcycle battery charger



1-40 Ah 6/12 Volt



IP65



SPECIFICATIONS:

- Power supply: 230V
- Power: 20W
- Voltage: 6/12V
- Charging current: 1A
- Nominal capacity: 1-40Ah

ACCESSORIES SUPPLIED WITH BATTERY CHARGER:

- Connecting clamps
- Connector with eyelet terminals
- Connector for lighter socket

1498CB/30

1 014980303

150x65x36 mm - 400 g

1498CB/80

electronic car/motorcycle battery charger



1-110 Ah 12 Volt



IP65



SPECIFICATIONS

- Power supply: 230V
- Power: 60W
- Voltage: 12V
- Charging current: 3,5A
- Nominal capacity: 1-110Ah

ACCESSORIES WITH BATTERY CHARGER:

- Connecting clamps
- Connector with eyelet terminals
- Connector for lighter socket

1498CB/80

1 014980308

188x82x45 mm - 600 g

1498CB/120

electronic car / commercial vehicle battery charger



SPECIFICATIONS

Power supply: 230V

Power: 110W

Voltage: 12V

Charging current: 6.5-1A

Nominal capacity: 4-190Ah

ACCESSORIES SUPPLIED WITH BATTERY CHARGER:

- Connecting clamps
- Connector with eyelet terminals
- Connector for lighter socket

1498CB/120

1 014980312

220x98x55 mm - 850 g

1498CB/300

electronic battery charger, 12-24V



TECHNICAL DATA

Power supply: 230V

Power: 350W

Voltage: 12-24V

Charging current: 15-10A

Nominal reference capacity: 30-500Ah

ACCESSORIES SUPPLIED WITH BATTERY CHARGER

- Connecting clamps
- Connector with eyelet terminals

1498CB/300

1 014980330

1498TB/W

wireless digital tester for batteries and recharging systems - start in plastic case



- Tests charging state, capacity and efficiency of battery
- Tests starting system
- Tests recharging system

FITTED WITH:

- Short-circuit protection device
- Temperature compensation system
- Software in 6 languages (I, EN, F, ES, PL, NL)
- Wireless data transmission system with 30-metre range in open field (only with 1498ST/W)

TECHNICAL DATA

- 12 volt battery test.
- Standard SAE, EN, IEC, DIN or JIS.
- Capacity: SAE 30-1500; EN 30-1500; IEC 30-1500; DIN 30-1500.
- 12 V and 24 V recharging systems (in series).

1498TB/W

1 014980071

1498ST/W

wireless printer with receiver
(for items 1498TB/W and 960TP)



TECHNICAL DATA

- Data reception range: up to 30 metres in open field
- Thermal printing
- Resolution: 203 dpi
- Printing speed (mm/sec): 60
- Paper width: 58 mm

1498ST/W

1 014980500

1499

sonoscope probe

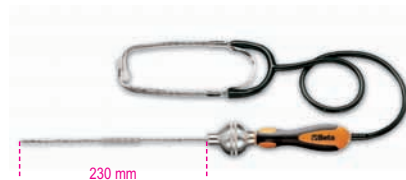

1499

1 014990001

1500/...

two-leg universal pullers

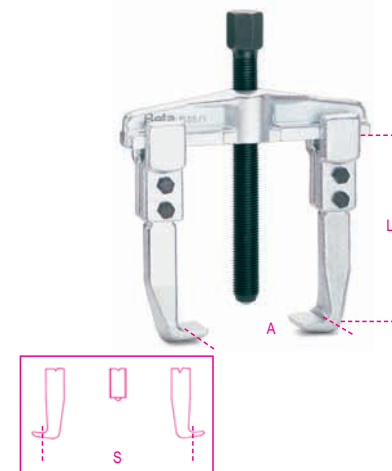

	L mm	
1500/1	100	1 015000301
1500/2	100	1 015000302
1500/3	150	1 015000303
1500/4	150	1 015000304
1500/5	205	1 015000305
1500/6	205	1 015000306
1500/7	205	1 015000307
1500/8	230	1 015000308

	A mm	S mm
1500/1	25+80	70+130
1500/2	25+130	80+180
1500/3	50+160	105+220
1500/4	60+200	120+270
1500/5	80+250	160+330
1500/6	80+350	160+420
1500/7	110+520	195+600
1500/8	170+640	260+715



1500/SP5	1 015000325
1500/1-1500/2-1500/3	
1500/4-1500/5	
1500/SPV	1 015000001

1500G/...

loose legs, standard series,
for items 1500 and 1580/8I



	L mm		
1500G/1	100	2	015000311
1500/1-2			
1500G/3	150	2	015000313
1500/3-4			
1500G/5	205	2	015000315
1500/7			
1500G/8	230	2	015000317
1500/8			
1580/8I			

1500N/...

universal pullers with 2 sliding legs

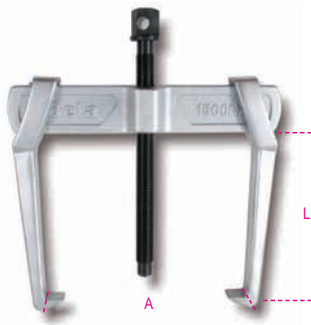

	L mm	A mm		
1500N/0	70	65	1	015000600
1500N/1	100	90	1	015000601
1500N/2	100	120	1	015000602
1500N/3	150	170	1	015000603
1500N/4	150	220	1	015000604
1500N/5	205	290	1	015000605
1500N/6	205	360	1	015000606



1500N/SP6		1	015000626
1500N/0-1500N/1-1500N/2			
1500N/3-1500N/4-1500N/5			
1500N/SPV		1	015000006

1500N/G...

loose legs for pullers 1500N



	L mm		
1500N/G0	70	2	015000650
1500N/0			
1500N/G1-2	100	2	015000651
1500N/1-2			
1500N/G3-4	150	2	015000653
1500N/3-4			
1500N/G5-6	205	2	015000655
1500N/5-6			

1501/1 - 2 - 3

thin leg pullers

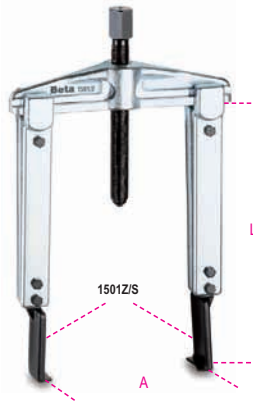

	L mm		
1501/1	100	1	015010101
1501/2	200	1	015010102
1501/3	250	1	015010103

	A mm
1501/1	25÷130
1501/2	25÷130
1501/3	25÷130

1501G/1 - 2 - 3

legs for item 1501



	L mm		
1501G/1	100	1	015010111
1501G/2	200	1	015010112
1501G/3	250	1	015010113

1501Z/S - P - R

leg ends for item 1501G



	A mm	D mm		
1501Z/S	2,0	27	2	015010211
1501Z/P	3,6	27	2	015010212
1501Z/R	3,6	14	2	015010213



1505

windshield wiper arm remover



	A mm		
1505	30÷35	1	015050010

1506

two-leg self-locking puller



	A mm		
1506	10÷50	1	015060001

1508/1 - 1508/2

two-leg pullers, light series



	L mm		
1508/1	105	1	015080001
1508/2	130	1	015080002

	A mm	L1 max mm
1508/1	6÷100	85
1508/2	10÷140	110

1515/1 - 2 - 3

pullers with two floating legs

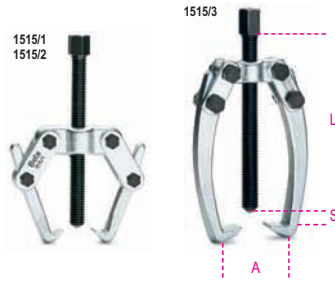

	L mm		
1515/1	85	1	015150101
1515/2	85	1	015150102
1515/3	105	1	015150103

	A max mm	S max mm
1515/1	60	40
1515/2	70	65
1515/3	90	85

1516/1 - 2 - 3

pullers with three floating legs



	L mm		
1516/1	85	1	015160001
1516/2	85	1	015160002
1516/3	105	1	015160003

	A max mm	S max mm
1516/1	60	40
1516/2	70	65
1516/3	90	85

1517

three-leg self-locking pullers

- For major pulling loads.
- Self-locking effect.



	L mm	∅ mm	● mm		
1517/150	242	22	19	1	015170010
1517/200	307	22	19	1	015170020
1517/260	395	30	27	1	015170030

	A mm	S max mm	kg	kn
1517/150	25÷150	115	6000	59000
1517/200	40÷200	150	6000	59000
1517/260	50÷260	180	8000	78500

1517G

legs for pullers item 1517



1517G/150	3	015170210
1517G/200	3	015170220
1517G/260	3	015170230

1517GS

thin legs for pullers item 1517



1517GS/150	3	015170209
------------	---	-----------

1517T

central body for pullers item 1517



1517T/150-200	1	015170410
1517T/260	1	015170430

1517V

spare screws for item 1517



	● mm	L mm		
1517V/1	19	242	1	015170110
1517V/2	19	307	1	015170120
1517V/3	27	395	1	015170130

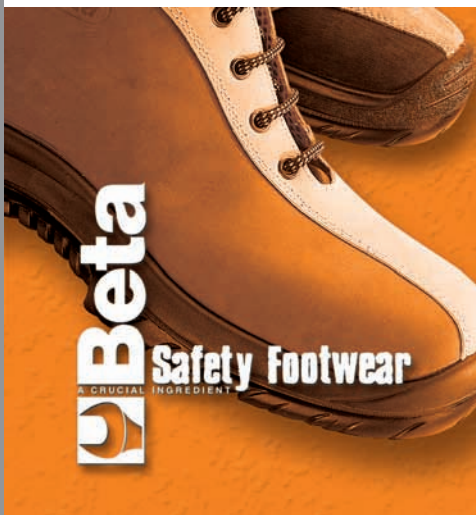

1518/...

three-leg pullers



	L mm		
1518/1	105	1	015180001
1518/2	135	1	015180002
1518/3	235	1	015180003
1518/4	270	1	015180004
1518/5	270	1	015180005
1518/6	270	1	015180006

	A mm	S max mm
1518/1	24÷100	105
1518/2	32÷160	150
1518/3	40÷220	220
1518/4	80÷250	240
1518/5	80÷300	350
1518/6	80÷350	400

Beta



1521/1 - 1521/2

pullers with three reversible legs



	L mm		
1521/1	135	1	015210101
1521/2	235	1	015210102

	A max mm	S max mm
1521/1	110	85
1521/2	160	140

1529

multi-step cone pulley puller

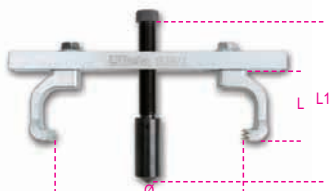

min Ø	max mm	L1 mm	L mm		
24÷240		140	90	1	015290000

260x210x60 mm - 2,6 kg

1530/3 - 1530/4

wheel hub pullers



	A max mm		
1530/3	225	1	015300030
1530/4	225	1	015300040

	D mm	n.
1530/3	18	3
1530/4	18	4

1530B

leg for puller item 1530



1530B	1	015300011
-------	---	-----------

1531/3 - 4 - 5

hub and wheel drum pullers

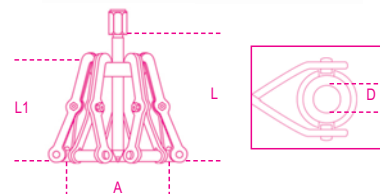

	A max mm		
1531/3	250	1	015310001
1531/4	250	1	015310002
1531/5	250	1	015310003

	D mm	L mm	L1 mm	n.
1531/3	14-18-22	210	135	3
1531/4	14-18-22	210	135	4
1531/5	14-18-22	210	135	5

1531B

leg for puller item 1531



1531B	1	015310201
-------	---	-----------

1532

packing removal tool



1532	2	015320001
------	---	-----------

1533/...

pullers for separators 1534

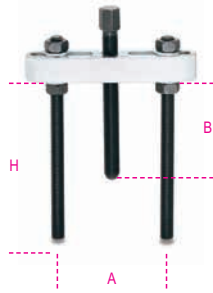

	H mm		
1533/2	150	1	015330002
1533/3	210	1	015330003
1533/4	315	1	015330004
1533/5	305	1	015330005

	A min mm	A max mm	B max mm
1533/2	45	134	110
1533/3	55	205	175
1533/4	90	260	170
1533/5	100	360	235

1533PR/1 - 2 - 3

extensions for pullers 1533



1533PR/1	1	015330011
1533/2		
1533PR/2	1	015330012
1533/3		
1533PR/3	1	015330013
1533/4-5		

1534/...

separators

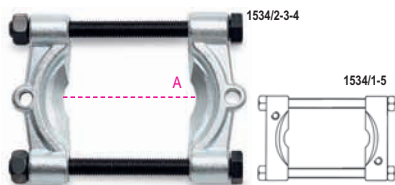

	1533/2		
1534/1	1533/2	1	015340001
1534/2	1533/2	1	015340002
1534/3	1533/3	1	015340003
1534/4	1533/4	1	015340004
1534/5	1533/5	1	015340005

	A max mm
1534/1	70
1534/2	85
1534/3	115
1534/4	150
1534/5	245

1535/C...

puller kits



1535/C1 1 015350001

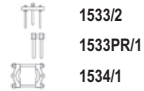

260x180x40 mm - 2,5 kg

1535/C2 1 015350002

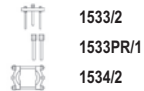

260x180x40 mm - 2,8 kg

1535/C3 1 015350003



380x280x55 mm - 8,0 kg

1535/C4 1 015350004



420x380x65 mm - 14,8 kg

1535/C5 1 015350005

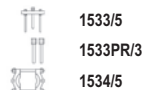

530x510x85 mm - 27,4 kg

1539

sheet sliding hammer



1539 1 015390001

1540

sliding hammer



1544/0÷7

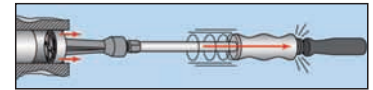
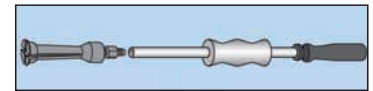

1540 M10 1 015400001

1542/1 - 1542/2

two-leg pullers for extractors



	A max mm		
1542/1	75	1	015420001
1544/0÷7			
1542/2	130	1	015420002
1544/9C			
1544/10C			

1544/...

two-leg internal extractors

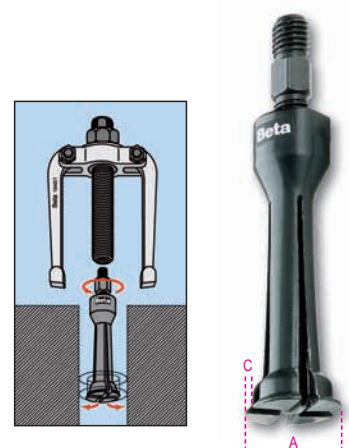

	C mm	M		
1544/0	0,25	M10	1	015440100
A= 5÷7 mm				
1544/A	0,80	M10	1	015440105
A= 7÷9 mm				
1544/1	0,80	M10	1	015440110
A= 9÷12 mm				
1544/2	1,15	M10	1	015440120
A= 13÷17 mm				
1544/2B	1,00	M10	1	015440121
A= 14÷19 mm				

	C mm	螺	图	图
1544/3	1,70	M10	1	015440130
A= 16÷21 mm				
1544/4	1,65	M10	1	015440140
A= 20÷25 mm				
1544/5	2,00	M10	1	015440150
A= 25÷30 mm				
1544/6	3,00	M10	1	015440160
A= 30÷37 mm				
1544/7	3,80	M10	1	015440170
A= 38÷45 mm				
1544/9C	2,60	G 3/8"	1	015440189
A= 40÷75 mm				
1544/10C	7,30	G 3/8"	1	015440199
A= 70÷115 mm				

1545/C5

puller 1542/1 with 5 extractors 1544



1545/C5	图	图
	1	015450001
1542/1	● 24 mm	
1544/1	9÷12 mm	
1544/2	13÷17 mm	
1544/3	16÷21 mm	
1544/4	20÷25 mm	
1544/5	25÷30 mm	
265x180x45 mm - 2,4 kg		



1547/C6

dummy ball bearing extractors



Bearings:
1547/1
 6004-6010, 6200-6205, 6300-6304
1547/2
 6011-6014, 6206-6211, 6303-6308, 6403-6405

1547/C6	图	图
	1	015470006

1547KP

set of 3 pairs of dummy ball terminals



1547KP/1	1547/1	图	图
		1	015470106
1547KP/2	1547/2	图	图
		1	015470206

1547P

hexagonal extensions



1547 P/1	1547/1	图	图
		1	015470101
1547 P/2	1547/2	图	图
		1	015470201

1547PC/2

round extensions, short series



1547PC/2	1547/2	图	图
		1	015470202

1547PL/2

round extensions, long series



1547PL/2	1547/2	图	图
		1	015470203

1550/1

pneumatic compressor for MacPherson and equivalent shock absorber springs

- Operating pressure: 6 bars - max. 8 bars
- Mean air consumption: 225 l/min

CE



1550/1	图	图
	1	015500001

1550/PS

shock absorber basket for item 1550/1



1550/PS	图	图
	1	015500057

1550/SR...

spare fork for item 1550/1

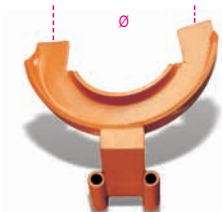

	Ø mm	图	图
1550/SR90	50÷90	1	015500050
1550/SR150	90÷150	1	015500051
1550/SR175	120÷175	1	015500052
1550/SR205	130÷205	1	015500053

1550/MRC

fork for (C and E class) Mercedes W203, W209 shock absorbers



1550/MRC 1 015500061

1555DS

compressor for Mac Pherson and equivalent shock absorber springs

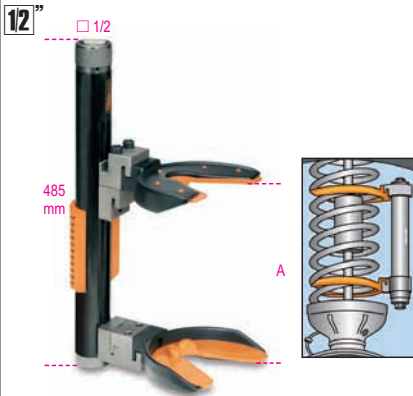

A	∅
min+Max	min+Max
mm	mm
50+350	80+200

1 015550000

1555S/MRC-C

fork for (C and E class) Mercedes W203, W209 shock absorbers, for items 1555DS and 1555/QS



1555S/MRC-C 1 015550301

1555S/BMW-RNT

fork for BMW E39, E46 and Renault Mégane II shock absorbers, for items 1555DS and 1555/QS



1555S/BMW-RNT 1 015550303

1555/QS

compressor for MacPherson and equivalent shock absorber springs



A	∅
min+Max	min+Max
mm	mm
70+300	90+205

1 015550005

1555C

telescopic compressor for shock absorber springs



∅	A	N
min+Max	min+Max	Kg
mm	mm	
90+160	80+225	25000
		2500

1 015550202

1555M

special vice for shock absorbers

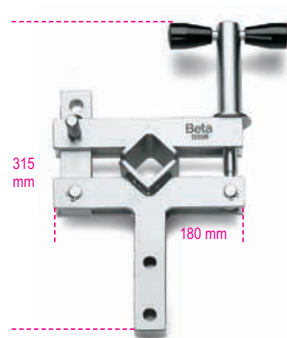

1555M 1 015550010

1556/1A

compressor for shock absorber springs

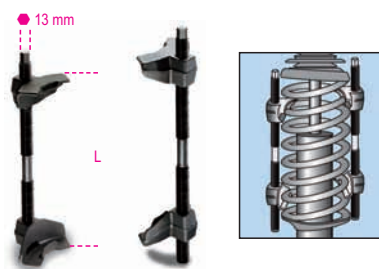

min L max
mm
65+320

1 015560101

1556/2A

compressor for shock absorber springs

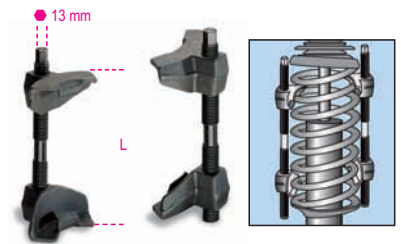

min L max
mm
65+200

1 015560102

1556/3A

compressor for shock absorber springs

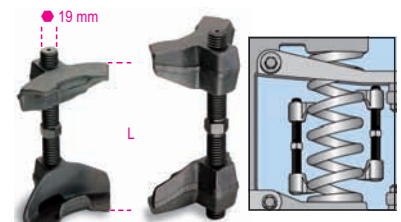

min L max
mm
87+170

1 015560103

1557

impact sockets for truck leaf springs



L	L1
mm	mm
37	28
46	34
56	34

1 015570137
1 015570146
1 015570156

1557V

impact sockets for Volvo leaf springs



mm
27

1 015570299

1557/S3

set of 3 sockets for shock absorber nuts



1557/S3 1 015570010

1559

ball joint puller, light series

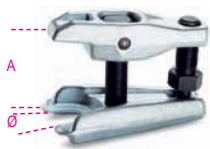

	A max mm	Ø mm		
1559/22	50	18÷22	1	015590001
1559/36	90	36	1	015590036
1559/45	115	45	1	015590045

1559V/8T

hydraulic screw for ball joint pullers 1559/36 and 1559/45



N	Kg		
80000	8000	1	015590145

1560/1 - 1560/2

ball joint pullers, professional type



	A mm		
1560/1	12÷50	1	015600001
1560/2	60÷85	1	015600002

1560A

ball joint puller



1560A		1	015600601

1561/...

ball joint pullers

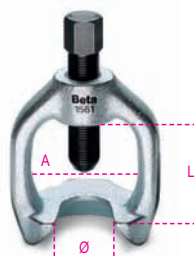

	L mm	A mm	Ø mm		
1561/1	39	36,6	18	1	015610001
1561/2	47	45,7	25	1	015610002
1561/3	63	62	30	1	015610003
1561/4	75	63	40	1	015610004

1562

ball joint puller



A max mm	Ø mm	● mm		
75	39	26	1	015620039

1565/1 - 2 - 3

fork separators for ball joints



	Ø mm	L1 mm		
1565/1	18	65	1	015650001
1565/2	23	65	1	015650002
1565/3	30	88	1	015650003

1566

wrench for removing steering arms



1566		1	015660001

1566GO

homokinetic joint puller

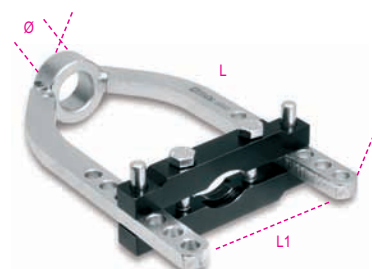

L mm	L1 mm	Ø mm		
250	100	29,5	1	015660051

1568/C13

chain opening and riveting kit



Ø mm			
3-4-5 mm		1	015680061

350x170x40 mm - 2,3 kg

1568R/CS3

punches for chain openers



1568R/CS3		1	015680503

1569/C11

set of bushing drivers



1569/C11		1	015690001

1390	28 mm	
	Ø 40-45-50-60-63-65-72-76-80 mm	

420x280x60 mm - 4,1 kg

1570/3

hydraulic presses for pullers



t			
30		1	015700003



1580/8I

two-leg hydraulic puller

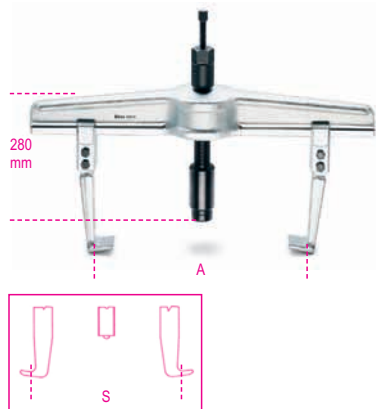

1580/8I 1 015800008

	A mm	S mm
1580/8I	170÷640	260÷715

1580GL

loose legs, long series, for pullers item 1580/8I



	L mm		
1580GL/8A	300	2	015800227
1580GL/8B	400	1	015800228
1580GL/8C	500	2	015800229

1585/5I - 6I - 7I

three-leg pullers for hydraulic use

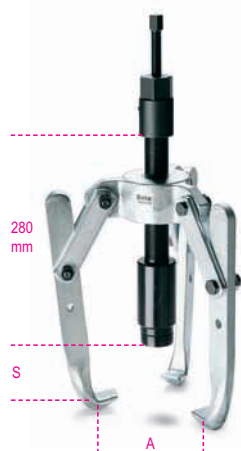

1585/5I 1 015850005
 1585/6I 1 015850006
 1585/7I 1 015850007

	A mm	S max mm
1585/5I	50÷350	135
1585/6I	50÷350	235
1585/7I	50÷450	335

1585GI/5 - 6 - 7

legs for hydraulic puller
1585/I-1585/6I-1585/7I

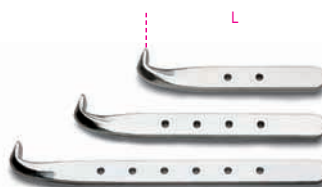

	L mm		
1585GI/5	135	1	015850205
1585GI/6	235	1	015850206
1585GI/7	335	1	015850207

1589VI

hydraulic screw for pullers
1580/8I and 1585/5I - 1585/6I - 1585/7I



1589VI 1 015890001

1589PI/50 - 100 - 150

extension sockets for hydraulic screw



	L mm		
1589PI/50	50	1	015890005
1589PI/100	100	1	015890010
1589PI/150	150	1	015890015

1590

standard clamps

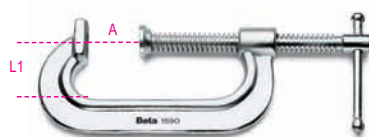

A max mm	L1 mm		
60	55	2	015900305
80	65	2	015900307
100	65	2	015900310
120	85	2	015900312
150	95	2	015900315

1591

screw clamps



A ~	A max mm	L1 mm		
200	200	80	2	015910020
300	310	85	2	015910030
400	410	85	2	015910040
500	500	95	2	015910050
600	600	95	2	015910060
800	800	95	2	015910080
1000	1000	110	2	015910100

1593

screw clamps

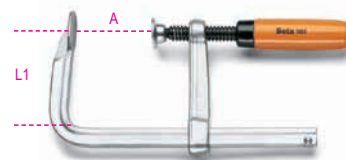

A ~	A max mm	L1 mm		
160	170	80	2	015930016
200	240	100	2	015930020
300	320	145	2	015930030
400	420	145	2	015930040
500	520	145	2	015930050
600	610	145	2	015930060

1594

lever bar clamps

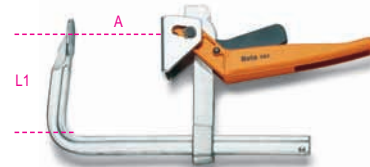

A ~	A max mm	L1 mm		
200	240	145	2	015940020
250	290	145	2	015940025
300	340	145	2	015940030
400	430	150	2	015940040
500	530	150	2	015940050
600	630	150	2	015940060

1594A

aluminium clamps



A ~	A max mm	L1 mm		
100	110	80	1	015940110
200	210	80	1	015940125
300	320	80	1	015940130

1594A/RG

rubber caps for clamps 1594A



1594A/RG 2 015940199

1595

screw clamps

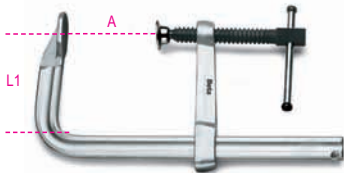

A	A max	L1		
~	mm	mm		
200	230	100	2	015950020
250	270	120	2	015950025
300	330	120	2	015950030
400	420	120	2	015950040
500	520	125	2	015950050
600	620	125	2	015950060
800	820	125	1	015950080
1000	1030	125	1	015950100

1596

nylon/fibreglass clamps



A max	L1		
mm	mm		
150	60	1	015960115
300	60	1	015960130
450	60	1	015960145

1596/RG

rubber caps for clamps 1596



1596 /RG	1	015960199
----------	---	-----------

1599M

parallel bench vices



A		
mm		
M100	100	1 015990281
M125	125	1 015990301
M150	150	1 015990302
M165	165	1 015990303

1599P

parallel bench vices



A		
mm		
100		1 015990000
125		1 015990025
150		1 015990050

1599B

revolving bases for vices item 1599P



	1599P		
1599B100	100	1	015990810
1599B125	125	1	015990812
1599B150	150	1	015990815

1599T

parallel drill vices

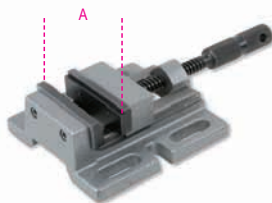

A		
mm		
80		1 015990480
100		1 015990500

1599G

pairs of aluminium jaw covers



A		
mm		
100		1 015990910
125		1 015990912
150		1 015990915
165		1 015990916

1601/PC

ratchet crimping pliers
for telephone terminals
and data transmission

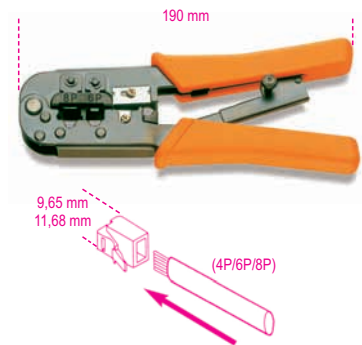

RJ11-RJ12-RJ45

2 016010011

1602

crimping pliers
for insulated terminals, light series



mm²
0,75÷6

5 016020001

1602/C9T

crimping pliers
with assortment of 450 terminals



1602/C9T

1 016020013

		n.
1602		1
1620	R/6,3	50
1620	B/6,3	50
1620	G/6,3	50
1624	R/6,3	50
1624	B/6,3	50
1624	G/6,3	50
1628	R/1,6	50
1628	B/2,3	50
1628	G/3,6	50

420x350x35 mm - 1,5 kg

1602A

crimping pliers for insulated terminals, standard model

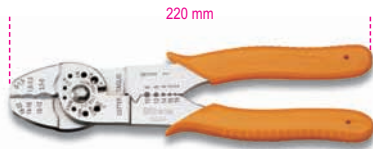

mm²
0÷8 2 016020005

1603

crimping pliers for non-insulated terminals, light series



mm²
1,25÷5,5 5 016030001

1603A

crimping pliers for non-insulated closed terminals, standard model

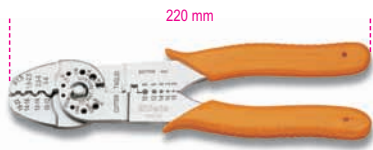

mm²
0÷8 2 016030005

1603B

crimping pliers for non-insulated open terminals, standard model

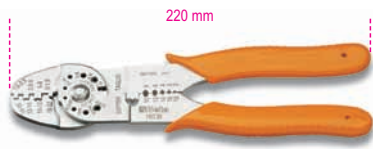

mm²
0÷8 2 016030010

1604

self-locking pliers for insulated terminals



mm²
0,5÷6 1 016040001

1604/C9T

self-locking pliers 1604 with assortment of 450 terminals



1604/C9T 1 016040013

		n.
1604		1
1620	R/6,3	50
1620	B/6,3	50
1620	G/6,3	50
1624	R/6,3	50
1624	B/6,3	50
1624	G/6,3	50
1628	R/1,6	50
1628	B/2,3	50
1628	G/3,6	50

420x350x35 mm - 2 kg

1605

self-adjusting pliers for non-insulated terminals



mm²
0,5÷6 1 016050001

1606

heavy duty crimping pliers for cylindrical terminals



mm²
0,5÷6 1 016060001

1606A

crimping pliers for tubular terminals



mm ²		
1606A6	0,5÷6	1 016060010
1606A16	6÷16	1 016060016

1606A/C9

crimping pliers for tubular terminals with assortment of 450 terminals, 0,5÷6 mm²



1606A/C9 1 016060100

		n.
1606A6		1
1632	W/0,5K	50
1632	N/1,5K	100
1632	B/2,5K	100
1632	G/4K	100
1632	Y/6K	100

420x350x35 mm - 2,5 kg

1607

heavy duty crimping pliers for BNC coaxial wires RG 58, RG 59, RG 62, RG 71



6,48 - 5,41 - 1,69 mm



1607 1 016070001

1608

crimping pliers for insulated terminals, with pressure regulator



mm²
0,5÷6 1 016080001

1608/C9T

pliers 1608
with assortment of 450 terminals



1608/C9T 1 016080013

1608	n.
1620 R/6,3	50
1620 B/6,3	50
1620 G/6,3	50
1624 R/6,3	50
1624 B/6,3	50
1624 G/6,3	50
1628 R/1,6	50
1628 B/2,3	50
1628 G/3,6	50

420x350x35 mm - 2 kg

1608A

heavy duty crimping pliers
for insulated terminals

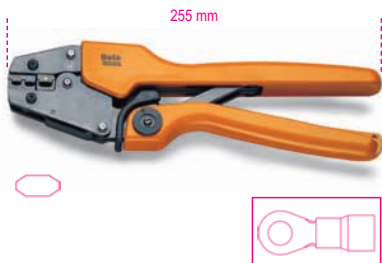

mm²
0,75÷6 1 016080005

1609

crimping pliers for non-insulated
terminals, professional model
fast performance



mm²
0,5÷2,5 1 016090001

1609A

heavy duty crimping pliers
for non-insulated terminals



mm²
0,5÷6 1 016090005

1609B

crimping pliers for noninsulated terminals

punch crimps,
10 mm² ÷ 120 mm²



L
mm
600 mm²
10÷120 1 016090101

1609C/C5

oil-pressure crimping pliers
with 5 pairs of dies

hexagonal crimps,
25 mm² ÷ 240 mm²



mm²
50÷240 1 016090210
500x300x110 mm - 4 kg

1609M

dies for item 1609C

hexagonal crimps



1609M/16	mm ²	1 016090221
1609M/35	25-35	1 016090223
1609M/70	50-70	1 016090225
1609M/120	95-120	1 016090227
1609M/150	150	1 016090229
1609M/185	185	1 016090231
1609M/240	240	1 016090233

1610

ring terminals

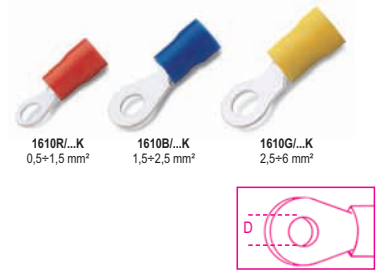

	D mm	1 016100104
1610R/4K	4	1 016100104
1610R/5K	5	1 016100105
1610B/5K	5	1 016100115
1610B/6K	6	1 016100116
1610B/8K	8	1 016100118
1610G/6K	6	1 016100126
1610G/8K	8	1 016100128

1614

pin terminals

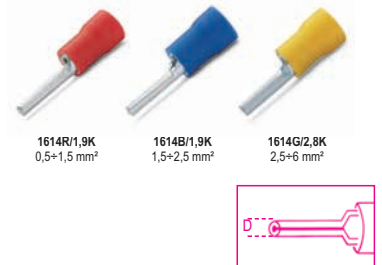

	D mm	1 016140101
1614R/1,9K	1,9	1 016140101
1614B/1,9K	1,9	1 016140102
1614G/2,8K	2,8	1 016140103

1616

male connectors



	D mm	1 016160104
1616R/4K	4	1 016160104

1618

female connectors

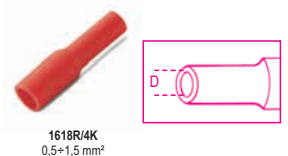

	D mm	1 016180104
1618R/4K	4	1 016180104

1620

male spade terminals



1620R/6,3K
0,5+1,5 mm²

HxS
6,3x0,8 mm

1620B/6,3K
1,5+2,5 mm²

HxS
6,3x0,8 mm

1620G/6,3K
2,5+6 mm²

HxS
6,3x0,8 mm

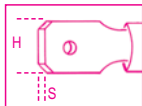

1620R/6,3K	1	016200101
1620B/6,3K	1	016200102
1620G/6,3K	1	016200103

1622

female spade terminals



1622R/2,8K
0,5+1,5 mm²

HxS
2,8x0,5 mm

1622B/6,3K
1,5+2,5 mm²

HxS
6,3x0,8 mm

1622G/6,3K
2,5+6 mm²

HxS
6,3x0,8 mm

1622R/6,3K
0,5+1,5 mm²

HxS
6,3x0,8 mm

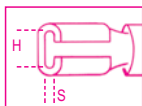

1622R/2,8K	1	016220101
1622R/6,3K	1	016220103
1622B/6,3K	1	016220106
1622G/6,3K	1	016220108

1624

insulated female terminals



1624R/6,3K
0,5+1,5 mm²

HxS
6,3x0,8 mm

1624B/6,3K
1,5+2,5 mm²

HxS
6,3x0,8 mm

1624G/6,3K
2,5+6 mm²

HxS
6,3x0,8 mm

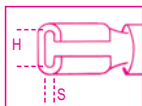

1624R/6,3K	1	016240102
1624B/6,3K	1	016240104
1624G/6,3K	1	016240105

1628

cable connectors



1628R/1,6K
0,5+1,5 mm²

1628B/2,3K
1,5+2,5 mm²

1628G/3,6K
2,5+6 mm²

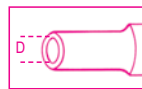

	D mm	
1628R/1,6K	1,6	1 016280101
1628B/2,3K	2,3	1 016280102
1628G/3,6K	3,6	1 016280103

1630

rapid connectors



1630R/K
0,5+1,5 mm²

1630B/K
1,5+2,5 mm²

1630R/K	1	016300101
1630B/K	1	016300102

1632

tube terminals



	mm ²	
1632W/0,5K	0,5	1 016320005
1632G/0,75K	0,75	1 016320007
1632R/1K	1	1 016320010
1632N/1,5K	1,5	1 016320015
1632B/2,5K	2,5	1 016320025
1632G/4K	4	1 016320040
1632Y/6K	6	1 016320060

1634

dual tube terminals



	mm ²	
1634W/0,5K	0,5	1 016340005
1634G/0,75K	0,75	1 016340007
1634R/1K	1	1 016340010
1634N/1,5K	1,5	1 016340015
1634B/2,5K	2,5	1 016340025
1634G/4K	4	1 016340040
1634Y/6K	6	1 016340060

1639NS-N

friction tape, black



L
m

25



10 016390025

1640K

punch press, with 4 punches

round holes
22.5-25.5-32.5-55 mm



1640K



1 016400001

1640

sheet metal punch press



1640



1 016400100

1640A

adapter for item 1640



1640A



1 016400080

1640P

threaded pin for item 1640



	ø mm	
1640P/9	9,5	1 016400088
1640P/19	19	1 016400089



1 016400088



1 016400089

1640Q

square punches for item 1640



mm			
1640Q/45	45x45	1	016400065

1640T

round punches for item 1640

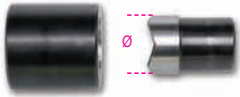

∅			
mm			
1640T/22,5	22,5	1	016400022
1640T/25,5	25,5	1	016400025
1640T/32,5	32,5	1	016400032
1640T/55,5	55,5	1	016400055

1650

workshop vernier
reading to 0.05 mm
reading to 1/128"

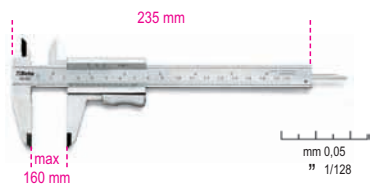

UNI/ISO 3599 DIN 862

1650		1	016500001
------	--	---	-----------

1650FD

sliding gauge for brake discs
reading to 0.1 mm

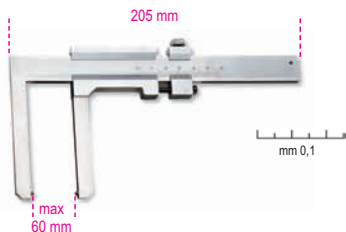

1650FD		1	016500050
--------	--	---	-----------

1650FT

sliding gauge for brake drums
made from stainless steel
reading to 0.05 mm



	A max	L		
	mm	mm		
1650FT	350	438	1	016500060
1650FT/2	500	550	1	016500070

1651DGT

digital vernier,
reading to 0.01 mm
reading to 0.0005"



DIN 862

1651DGT		1	016510111
---------	--	---	-----------

1652

analogue vernier,
analogue reading to 0.02 mm

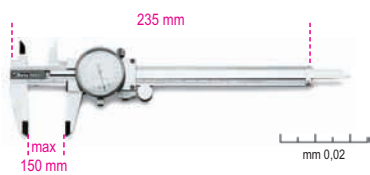

DIN 862

1652		1	016520016
------	--	---	-----------

1654

workshop verniers,
reading to 0.02 mm

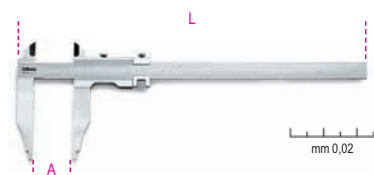

UNI/ISO 6906 DIN 862

A max	L		
mm	mm		
200	330	1	016540020
300	410	1	016540030

1654DGT

digital vernier,
reading to 0.01 mm
reading to 0.0005"

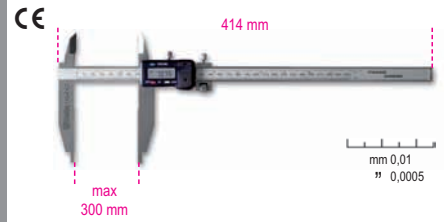

DIN 862

1654DGT		1	016540111
---------	--	---	-----------

1656

depth gauge, reading to 0.02 mm

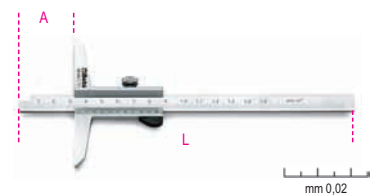

DIN 862

A max	L		
mm	mm		
200	260	1	016560020
300	360	1	016560030

1657DGT/2

digital depth gauge
reading to 0.01 mm
reading to 0,0005"

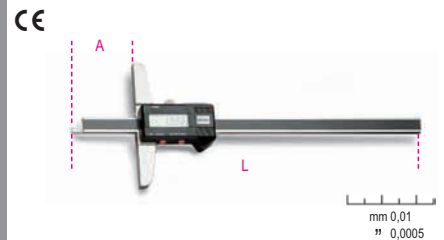

DIN 862

A max	L		
mm	mm		
1657DGT/2	200	270	1 016570002

1658/...

outside micrometers,
reading to 0.01 mm



DIN 863/II

A			
mm			
1658/25	0÷25	1	016580025
1658/50	25÷50	1	016580050
1658/75	50÷75	1	016580075
1658/100	75÷100	1	016580100



1658/C4

assortment of 4 micrometers
item 1658



1658/C4 1 016580001

- 1658/25 0÷25 mm
- 1658/50 25÷50 mm
- 1658/75 50÷75 mm
- 1658/100 75÷100 mm

365x245x35 mm - 2,5 kg

1658DGT

outside micrometers,
reading to 0.001 mm

CE



DIN 863

- | A mm | | |
|------------|-------|-------------|
| 1658DGT/25 | 0÷25 | 1 016580325 |
| 1658DGT/50 | 25÷50 | 1 016580350 |

1658SP/1

base for micrometer
made from cast iron



1658SP/1 1 016580910

1659

thickness gauge with dial indicator,
reading to 0.01 mm.

C=dial field

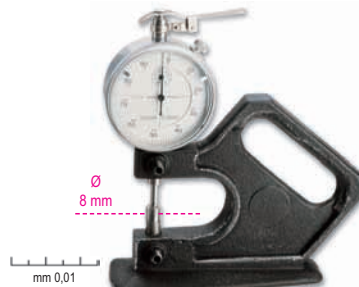

1659 C mm 0÷10 1 016590001

1662/1 - 1662/2

dial indicator, reading to 0.01 mm

C=dial field



DIN 878 C mm 1662/1 0÷5 1 016620001
1662/2 0÷10 1 016620010

1662DGT

digital dial indicator,
reading to 0.01 mm

C=Dial field

CE



DIN 878 C mm 1662DGT 0÷12,5 1 016620310

1662AN

adjustable stylus dial indicator,
reading to 0.01 mm

C=Dial field



DIN 2270 C mm 1662AN 0÷0,8 1 016620200

1662SP0

magnetic base



1662SP0 1 016620800

1662SP2

magnetic base, rotating



1662SP2 1 016620910

1666A

flanged precision squares
made from stainless steel ground
and lapped



DIN 875/0

L mm	L1 mm	
100	70	1 016660110
150	100	1 016660115
200	130	1 016660120
250	170	1 016660125
300	200	1 016660130

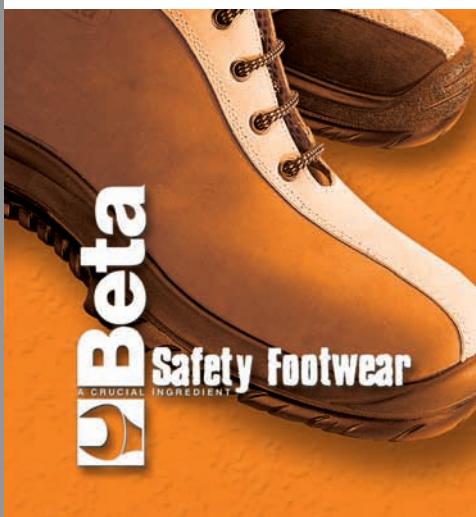

1668A

flanged precision squares
made from normalised, ground steel



DIN 875/2

L mm	L1 mm	
100	70	2 016680110
150	100	2 016680115
200	130	2 016680120
250	165	1 016680125
300	176	1 016680130

1670

precision squares
made from ground steel



L mm	L1 mm	
100	70	3 016700010
150	100	3 016700015
200	130	3 016700020
250	160	3 016700025
300	180	3 016700030
400	200	2 016700040
500	250	2 016700050
600	300	2 016700060
750	375	1 016700080
1000	500	1 016700099

1670A

flanged precision squares
made from ground steel



L mm	L1 mm	
100	70	3 016700110
150	100	3 016700115
200	130	3 016700120
250	160	3 016700125
300	180	3 016700130
400	200	2 016700140
500	250	2 016700150
600	300	2 016700160
800	400	1 016700180
1000	500	1 016700199

1672

mitre square, adjustable sliding blade,
base and blade made from steel

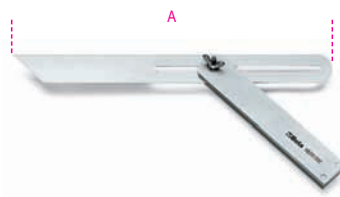

A mm	
300	2 016720030

1672A

mitre square, adjustable,
sliding blade, aluminium base,
blades made from chrome-plated steel

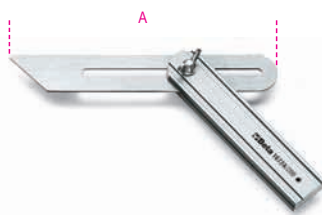

A mm	
200	3 016720120
300	3 016720130

1674A

carpenter's squares blades
made from stainless steel,
with aluminium bases, double metric scale



L mm	L1 mm	
300	169	2 016740130
400	214	2 016740140

1676

protractors made from stainless steel

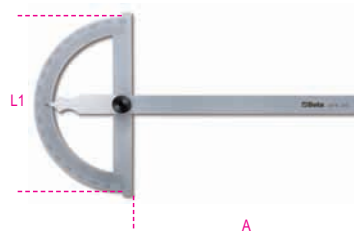

A ~	A mm	L1 mm	
120	120	80	2 016760012
150	165	120	2 016760015
200	210	150	2 016760020
300	310	200	1 016760030

1678/C3

bevel protractor
made from stainless steel



1678/C3	1 016780030
---------	-------------

1679

universal gauge with contact-roll,
made from stainless steel,
reading to 0.1 mm

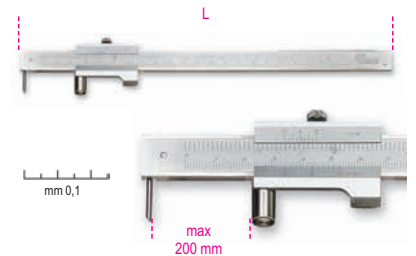

L mm	
265	1 016790020

1680

trammels, hardened steel body
and tips

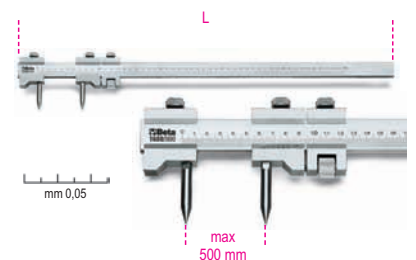

L mm	
612	1 016800050

1680A

inside callipers



L mm	A mm	
150	144	2 016800115
200	200	2 016800120
250	245	1 016800125
300	300	1 016800130

1680B

outside callipers



L mm	A mm		
150	155	2	016800215
200	190	2	016800220
250	235	1	016800225
300	280	1	016800230

1680C

precision dividers,
hardened steel straight tips



L mm	A mm		
150	138	2	016800315
200	190	2	016800320
250	235	1	016800325
300	280	1	016800330

1682

flexible graduated rules
made from stainless steel



L mm			
150		5	016820015
200		5	016820020
250		5	016820025
300		5	016820030
500		2	016820050
1000		2	016820100

1683

semi-rigid graduated rules
made from stainless steel

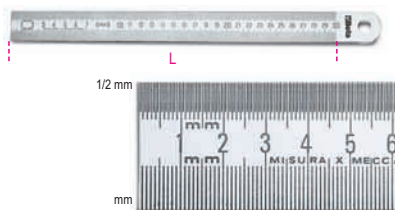

L mm			
300		5	016830030
500		2	016830050
1000		2	016830100
1500		1	016830150
2000		1	016830200

1685/C7

assortment of 7 measuring and marking tools



1685/C7 1 016850110

	1650	160 mm
	1658/25	0÷25 mm
	1670	100 mm
	1680C	150 mm
	1682	150 mm
	1688BC	165 mm
	1688BC/R	

320x210x37 mm - 1,2 kg

1687A

engineer's precision scriber,
tip bent at 90°, with handle



1687A 1 016870120

1687AC

engineer's precision scriber,
short tip bent at 90°, with handle

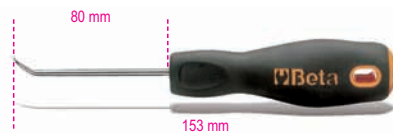

1687AC 1 016870125

1687D

engineer's precision scriber,
straight tip, with handle

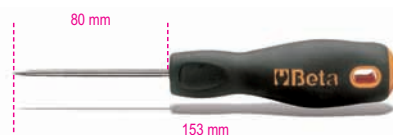

1687D 1 016870110

1687U

engineer's precision scriber,
hook tip, with handle

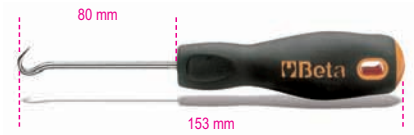

1687U 1 016870115

1687/S4

set of 4 engineer's precision scribers,
with handles



1687/S4 1 016870150
1687A-1687AC
1687D-1687U

1688

engineer's scriber
made from hardened steel



1688 5 016880020

1688A

engineer's scriber
made from hardened steel



1688A 5 016880120

1688BC

engineer's scriber
made from chrome-plated, hardened steel



1688BC 1 016880200

1688BC/R

spare tip for item 1688BC



1688BC/R 1 016880210

1688M

carpenter's pencil

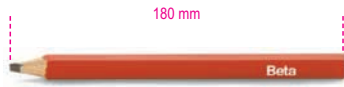

1688M 50 016880880

1690F

folding ruler made of fibreglass
precision class III



L	S		
m	mm		
1690F/2	2	17	5 016900220

1690L

folding ruler made of birch
precision class III

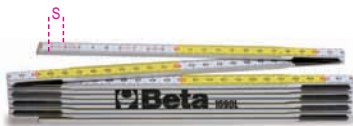

L	S		
m	mm		
1690L/2	2	17	5 016900200

1691A

measuring tape
shock-resistant ABS casing
nylon-coated tape
precision class II



L	S		
m	mm		
1691A/5	5	19	5 016910055
1691A/8	8	25	5 016910058

1692

measuring tapes,
shock-resistant bi-material ABS casings,
steel tapes,
precision class II



L	S		
m	mm		
1692/2	2	16	5 016920052
1692/3	3	16	5 016920053
1692/5	5	19	5 016920055
1692/8	8	25	5 016920058

1694/L

measuring tapes shock-resistant
ABS casings, PVC-coated fibreglass tapes,
precision class III

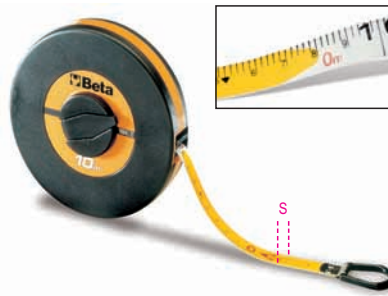

	L	S		
	m	mm		
1694/L10	10	13	1	016940110
1694/L20	20	13	1	016940120

1694A/L

measuring tapes with handles,
shock-resistant ABS casings,
PVC-coated fibreglass tapes,
precision class III



	L	S		
	m	mm		
1694A/L30	30	13	1	016940230
1694A/L50	50	13	1	016940250

1694B/L

measuring tape with handle,
aluminium casing, varnished steel tape,
precision class II



	L	S		
	m	mm		
1694B/L	50	12,5	1	016940350

1695

laser distance gauge

FEATURES:

- Area and volume calculation.
- Indirect measurement (Pythagoras).
- Addition/Subtraction.
- Continuous measurement.
- Min/max distance reading.



CE

IP54

TECHNICAL DATA

Measuring range: 0.05+50 m
Scale selection: m, in, ft
Accuracy: ± 1.5 mm
Laser class: 2
Laser power: 635 nm, <1mW
Stored measurement values: 20
Operating temperature: 0°C + 40°C / 32°F + 104°F
LCD display, backlit
Data saving function
Self-power down
Power supply: 2 x 1.5V AAA/9V batteries (included)
Soft cloth bag (included)
Operating manual
Weight: 135 g

1695 1 016950000

1696

spirit levels made from anodized profile
aluminium, with 2 unbreakable vials,
accuracy: 1 mm/m



L			
mm			
200	2	016960002	
400	2	016960004	
500	2	016960005	
600	2	016960006	
800	2	016960008	
1000	2	016960010	

1696A

spirit levels made from die-cast
aluminium, with 1 ground base
and 2 unbreakable vials, accuracy: 1 mm/m



L			
mm			
300	2	016960103	
400	2	016960104	
500	2	016960105	
600	2	016960106	
800	2	016960108	
1000	2	016960110	



1696B

spirit levels with magnetic bases made from anodized profiled aluminium, 2 unbreakable vials accuracy: 1 mm/m



L mm	
300	2 016960203
400	2 016960204
500	2 016960205
600	2 016960206

1696D

spirit levels made of die-cast aluminium with handles, 4 ground bases and 3 unbreakable vials, accuracy: 1 mm/m



L mm	
300	2 016960353
400	2 016960354
500	2 016960355
600	2 016960356

1696S

levelling staffs made from aluminium, with 2 unbreakable vials



L mm	
1500	1 016960415
2000	1 016960420
2500	1 016960425
3000	1 016960430

1699L

precision surface level made from die-cast iron with ground prismatic base, 2 unbreakable vials, accuracy: 0.05 mm/m



DIN 877

1699L	1 016990002
-------	-------------

1699L/1

precision surface level made from die-cast iron with ground prismatic base, 2 unbreakable vials, accuracy: 0.02 mm/m



DIN 877

1699L/1	1 016990005
---------	-------------

1699Q

precision square levels made from die-cast iron with 2 prismatic bases and 2 ground flat bases, 2 unbreakable vials, accuracy: 0.05 mm/m



DIN 877

L mm	A mm	
150	36	1 016990015
200	45	1 016990020

1700N

masonry points



L mm	S mm	
250	16	5 017000005
300	16	5 017000006

1700N/PM

masonry points with hand guards



L mm	S mm	
250	16	2 017000105
300	16	2 017000106

1701N

masonry chisels



L mm	A mm	S mm	
250	23	16	5 017010001
300	23	16	5 017010003

1701N/PM

masonry chisels with hand guards



L mm	A mm	S mm	
250	23	16	2 017010101
300	23	16	2 017010103

1701PMR

hand guards for items 1700N and 1701N



D mm	L mm	
16	115	1 017010206

1701NE/...

electrician's chisels



	SxL mm	
1701NE/3	10x200	5 017010406
1701NE/4	10x250	5 017010409

1702N

extra-wide chisels



A mm	SxH mm	
50	12x25	2 017020005
70	12x25	2 017020007

1702N/PM

extra-wide chisels with hand guards

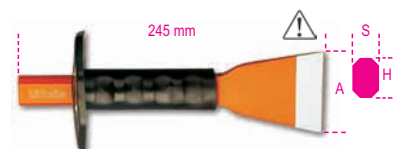

A mm	SxH mm	
50	12x25	2 017020105
70	12x25	2 017020107



We recommend frequent cooling of the tool while regrinding it.

1702PMR

hand guard for item 1702N



L mm		
115	1	017020200

1704

carpenter's wrenching bars

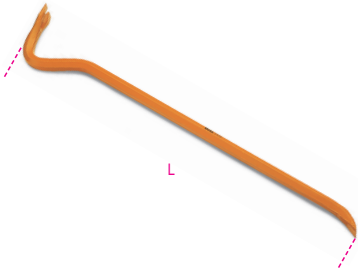

L mm		
500	2	017040050
600	2	017040060
800	2	017040080

1704A

crow bars with open and pointed edges

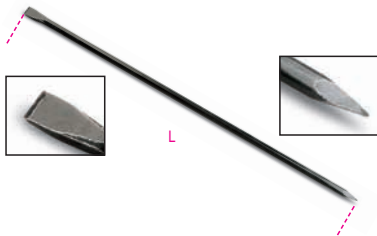

L mm		
1500	1	017040110
2000	1	017040120

1704C

crow bars with closed and pointed edges

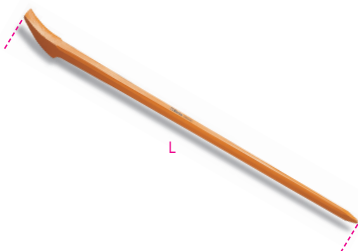

L mm		
1200	1	017040210
1400	1	017040212
1600	1	017040215

1705

chalk line reel made from aluminium



1705	4	017050001

1705PT

chalk powder



g		
250	5	017050025

1706DGT

digital depth gauge for tyre threads



1706DGT	1	017060011

1707

screw pitch gauge

For ISO 60° metric and Whitworth 55° threads



P (ISO)	W	
0,25÷6	62÷4x1"	5 017070001

1707A/1 - 2 - 3

radius gauges,
concave and convex steel blades



	R mm	
1707A/1	1,0÷7,0	2 017070007
1707A/2	7,5÷15	2 017070015
1707A/3	15,5÷25	2 017070025

1708/8 - 13 - 20

metric feeler gauges



1708/8	S = 0,05÷0,50 mm	5 017080008
1708/13	S = 0,05÷1,00 mm	5 017080013
1708/20	S = 0,05÷1,00 mm	5 017080020

1709/10 - 1709/18

nut splitters



	L mm	A max mm	
1709/10	90	17 (M10)	1 017090010
1709/18	108	25 (M16)	1 017090018

1710

hydraulic nut splitters



A min mm	A max mm	
7(M4)	22(M14)	1 017100001

1712E/1 - 2 - 3

flexible magnetic pick up tools

F = magnetic power



	L mm	D mm	F kg	
1712E/1	420	7,5	0,5	5 017120011
1712E/2	530	15	1,8	5 017120012
1712E/3	532	19	3,0	5 017120013

1712E/L1

flexible magnetic pick-up tool with LED light

F = magnetic force
Battery: 2xLR48

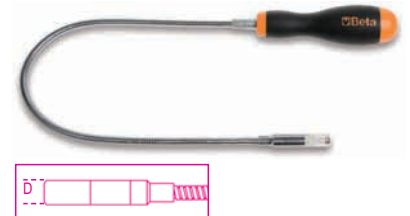

	L mm	D mm	F kg	
1712E/L1	500	6,5	0,75	3 017120111

1713M

flexible pickup tools

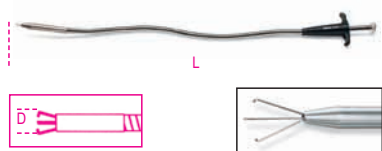

L mm	D mm	QTY	Part No.
500	7	2	017130011
1000	7	1	017130015

1714

inspection mirror made from plastic



1714	5	017140001
------	---	-----------

1715

telescopic joint inspection mirror
chrome-plated metal body



1715	1	017150001
------	---	-----------

1715FL/A

square flexible inspection mirror



1715FL/A	1	017150110
----------	---	-----------

1715FL/B

rectangular flexible inspection mirror
with light

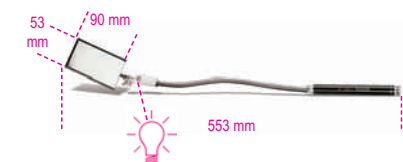

1715FL/B	1	017150115
----------	---	-----------

1716R

round bit reamer



1716R	5	017160001
-------	---	-----------

1716Q

square bit reamer

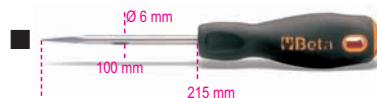

1716Q	5	017160010
-------	---	-----------

1716A

angled bit for general use

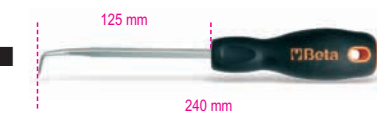

1716A	3	017160040
-------	---	-----------

1716P

packing scraper



1716P	3	017160020
-------	---	-----------

1716U

hook bit for general use



1716U	3	017160025
-------	---	-----------

1717A

scrapers, two cutting edges



L mm	L1 mm	QTY	Part No.
150	70	5	017170015
200	75	5	017170020
250	100	5	017170025

1717B

scrapers, three cutting edges



L mm	L1 mm	QTY	Part No.
150	75	5	017170115
200	85	5	017170120
250	100	5	017170125

1717C

flat scrapers, varnished



L mm	S mm	QTY	Part No.
150	18	5	017170215
200	20	5	017170220
250	25	5	017170225

1717D

flat scraper, front cut



1717D	5	017170320
-------	---	-----------

1718A6/...

6" second cut files without handles

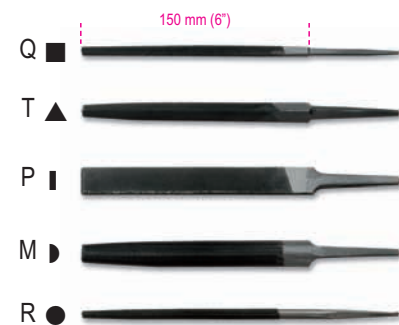

File Type	QTY	Part No.
1718A6/Q	5	017180021
1718A6/T	5	017180023
1718A6/P	5	017180025
1718A6/M	5	017180027
1718A6/R	5	017180029

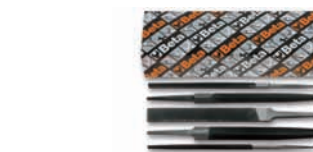

1718A6/S5	1	017180030
-----------	---	-----------

1718A8/...

8" second cut files without handles

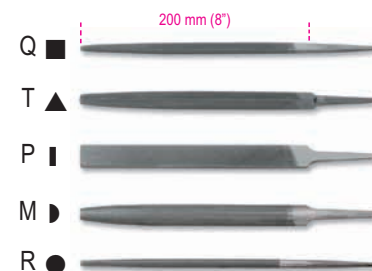

File Type	QTY	Part No.
1718A8/Q	5	017180031
1718A8/T	5	017180033
1718A8/P	5	017180035
1718A8/M	5	017180037
1718A8/R	5	017180039

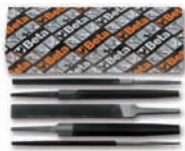

1718A8/S5 1 017180040

1718A10/...

10" second cut files without handles



1718A10/Q 5 017180041
 1718A10/T 5 017180043
 1718A10/P 5 017180045
 1718A10/M 5 017180047
 1718A10/R 5 017180049



1718A10/S5 1 017180050

1718D6/...

6" bastard cut files without handles

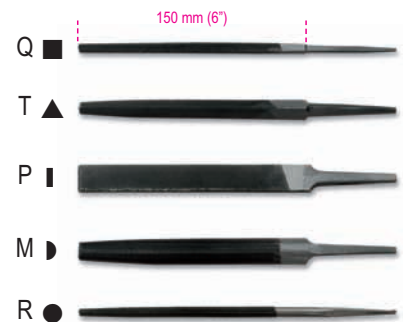

1718D6/Q 5 017180121
 1718D6/T 5 017180123
 1718D6/P 5 017180125
 1718D6/M 5 017180127
 1718D6/R 5 017180129



1718D6/S5 1 017180130

1718D8/...

8" bastard cut files without handles

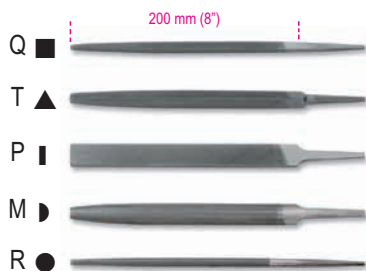

1718D8/Q 5 017180131
 1718D8/T 5 017180133
 1718D8/P 5 017180135
 1718D8/M 5 017180137
 1718D8/R 5 017180139



1718D8/S5 1 017180140

1718D10/...

10" bastard cut files without handles



1718D10/Q 5 017180141
 1718D10/T 5 017180143
 1718D10/P 5 017180145
 1718D10/M 5 017180147
 1718D10/R 5 017180149



1718D10/S5 1 017180150

1719BMA

second cut files, plastic handles

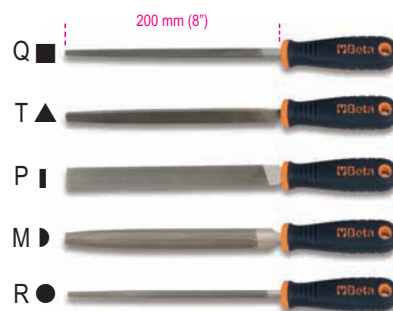

1719BMA/Q 5 017190052
 1719BMA/T 5 017190054
 1719BMA/P 5 017190056
 1719BMA/M 5 017190058
 1719BMA/R 5 017190060



1719BMA/S5 1 017190070

1719BMB/P

universal cut flat files, plastic handles

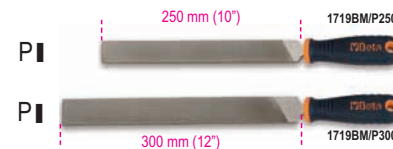

1719BMB/P250 5 017190152
 1719BMB/P300 5 017190153

1719BMC

half-round and flat files, plastic handles



1719BMC/M250 6 017190252
 1719BMC/M300 4 017190253
 1719BMC/P250 6 017190262
 1719BMC/P300 4 017190263



1719BMD8

8" bastard cut files plastic handles

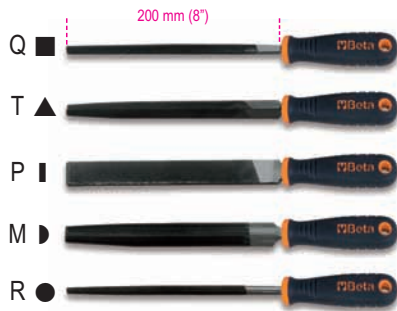

1719BMD8/Q	5	017190221
1719BMD8/T	5	017190223
1719BMD8/P	5	017190225
1719BMD8/M	5	017190227
1719BMD8/R	5	017190229



1719BMD8/S5	1	017190230
-------------	---	-----------

1719BM/RR

round rasp, plastic handle



1719BM/RR	5	017190351
-----------	---	-----------

1719BM/RL

flat rasp file, plastic handle



1719BM/RL	5	017190360
-----------	---	-----------

1719BMR

handles for files



	L mm	A mm		
1719BMR/0	95	25	10	017190950
1719BMR/1	110	29	10	017190951
1719BMR/1B	110	29	10	017190953
1719BMR/2	123	31	10	017190952

	mm	"	
1719BMR/0	100/150	4/6	▲ ■ ●
1719BMR/1	150/200	6/8	▲ ■ ●
1719BMR/1B	150/200	6/8	● ■
1719BMR/2	250/300	10/12	▲ ■ ●

1720/...

needle files

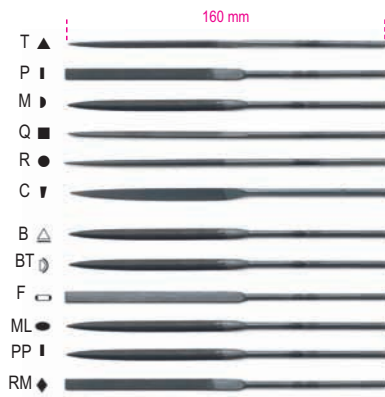

1720T	5	017200004
1720P	5	017200006
1720M	5	017200008
1720Q	5	017200009
1720R	5	017200010
1720C	5	017200012
1720B	5	017200005
1720ML	5	017200007
1720BT	5	017200011
1720F	5	017200013
1720PP	5	017200014
1720RM	5	017200015



1720/S3	1	017200000
---------	---	-----------

1720/B

set of 6 needle files in plastic wallet



1720/B6	1	017200002
1720/B12	1	017200003

1720D/...

diamond needle files

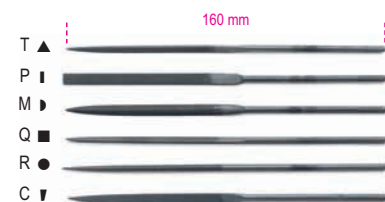

1720D/T	2	017200104
1720D/P	2	017200106
1720D/M	2	017200108
1720D/Q	2	017200109
1720D/R	2	017200110
1720D/C	2	017200112



1720D/B6	1	017200120
----------	---	-----------

1721/B6

set of 6 files for ignition contacts in plastic wallet



1721/B6	1	017210010
---------	---	-----------

1723

spring puller



1723	5	017230001
------	---	-----------

1725

hacksaw frame



1725	4	017250001
------	---	-----------

1725CR

mini hacksaw frame



1725CR	5	017250010
--------	---	-----------

1726

hacksaw frame, blade attachment system in the handle

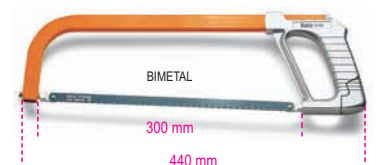

1726	4	017260001
------	---	-----------

1726BM

hacksaw frame with quick release blade attachment system



1726BM 1 017260050

1727

hacksaw frame, heavy series



1727 4 017270001

1727M

hacksaw frame, one hand grip



1727M 5 017270010

1728...

blades for hacksaw frames

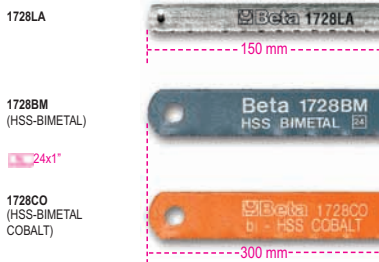

1728LA 100 017280001

1725CR 100 017280010

1725MQ 100 017280010

1728BM 100 017280010

1725-1726 100 017280030

1727-1727M 100 017280030

1728CO 100 017280030

1725-1726 100 017280030

1727-1727M 100 017280030

1729

fixed frame hacksaw

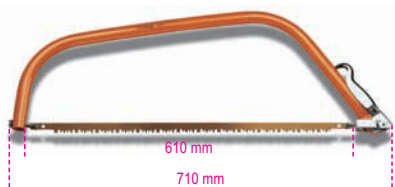

1729 5 017290001

1729LR

spare blade for item 1729



1729LR 10 017290010

1736A

file brush



1736A 10 017360010

1737

brush, brass wires



1737 10 017370001

1737NX

brake shoe cleaning brush
plastic handle steel wires



1737NX 5 017370010

1737AC

steel wire brush



1737AC 5 017370020

1737B

pairs of battery lug and post cleaner steel brushes



1737B 1 017370050

1738

bristle brush



1738 10 017380001

1739A

lazy tongs riveter, supplied with 5 interchangeable nozzles



Ø mm	3,2	4	4,8	5	6	6,4
aluminium	•	•	•	•	•	•
stainless steel	•	•	•	•		

1739A 1 017390101

1740A

heavy duty riveting pliers supplied with 5 interchangeable nozzles



Ø mm	3,2	4	4,8	5	6	6,4
aluminium	•	•	•	•	•	•
stainless steel	•	•	•	•		

1740A 1 017400101

1740B

compact heavy-duty riveting pliers



Ø mm	2,4	3	3,2	4,8
aluminium	•	•	•	•
stainless steel	•	•	•	•

1740 B280 280 1 017400280

Ø mm	3,2	4	4,8	5	6	6,4
aluminium	•	•	•	•	•	•
stainless steel	•	•	•	•	•	•

1740 B330 330 1 017400330

1741B

riveting pliers supplied
with 4 interchangeable nozzles



Ø mm	2,4	3,2	4	4,8	5
Aluminium	•	•	•	•	•
Steel	•	•	•	•	•
Stainless steel	•	•	•		

1741B 1 017410000

1741B/C5

riveting pliers item 1741B with assortment
of 700 aluminium rivets



1741B/C5 1 017410025

	Ø mm	L mm	n.
1741RV2,9K	3,0	6	200
1741RV3,2K	3,2	8	200
1741RV3,8K	4,0	10	100
1741RV4K	4,0	12	100
1741RV4,8K	4,8	12	100

415x155x60 mm - 3150 g

1741BP

riveting pliers supplied
with 4 interchangeable nozzles



Ø mm	2,4	3,2	4	4,8	5
Aluminium	•	•	•	•	•
Steel	•	•	•	•	•
Stainless steel	•	•	•	•	•

1741BP 1 017410350

1741RV...K

aluminium rivets

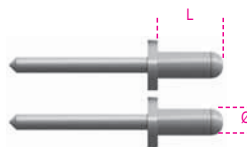

1741RV2,9K	1	017410191
ØxL = 3x6 mm		
1741RV3,2K	1	017410192
ØxL = 3,2x8 mm		
1741RV3,8K	1	017410193
ØxL = 4x10 mm		
1741RV4K	1	017410194
ØxL = 4x12 mm		
1741RV4,8K	1	017410195
ØxL = 4,8x12 mm		

1742

riveting pliers for threaded rivets,
with 4 interchangeable mandrels



1742 1 017420001

M	Ø mm	L mm
3	5	11
4	6	11
5	7	13
6	9	17

1742KR

kit with 4 spare mandrels for item 1742



1742 KR/M3	M3	1	017420043
1742 KR/M4	M4	1	017420044
1742 KR/M5	M5	1	017420045
1742 KR/M6	M6	1	017420046

1742R-A/M...

threaded steel rivets for item 1742-1742A



1742R-A/M3	1	017420013
ØxL = 5x11 mm		
M = 3		
1742R-A/M4	1	017420014
ØxL = 6x11 mm		
M = 4		
1742R-A/M5	1	017420015
ØxL = 7x13 mm		
M = 5		
1742R-A/M6	1	017420016
ØxL = 9x17 mm		
M = 6		
1742R-A/M8	1	017420018
ØxL = 11x17 mm		
M = 8		
1742R-A/M10	1	017420020
ØxL = 13x24 mm		
M = 10		

1742R-AL/M...

threaded aluminium rivets
for items 1742 - 1742A



1742R-AL/M3	1	017420023
ØxL = 5x10 mm		
M = 3		
1742R-AL/M4	1	017420024
ØxL = 6x12 mm		
M = 4		
1742R-AL/M5	1	017420025
ØxL = 7x13 mm		
M = 5		
1742R-AL/M6	1	017420026
ØxL = 9x15 mm		
M = 6		

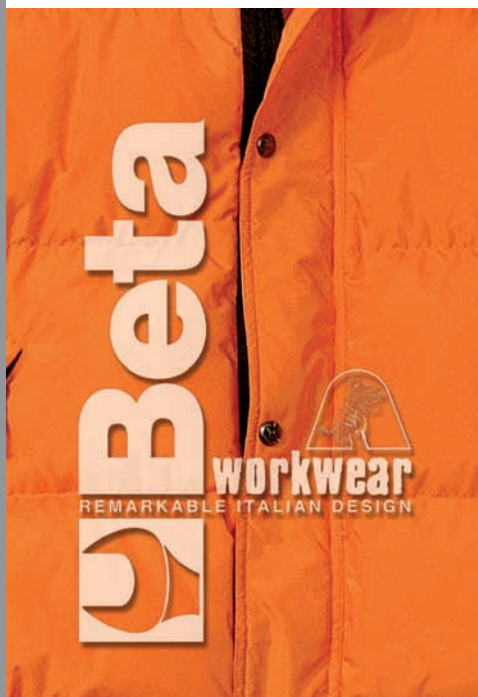

1742/C4

riveting pliers item 1742
with assortment of 400 threaded
steel insets



1742/C4 1 017420005

	M	Ø mm	n.
1742R-A/M3	3	5	100
1742R-A/M4	4	6	100
1742R-A/M5	5	7	100
1742R-A/M6	6	9	100

415x155x60 mm - 2,9 kg

1742A

heavy duty riveting pliers for threaded insets,
with 4 interchangeable mandrels



1742A 1 017420100

M	Ø mm	L mm
5	7	13
6	9	17
8	11	17
10	13	24

1742A/KR

kit with 4 spare pins for item 1742A

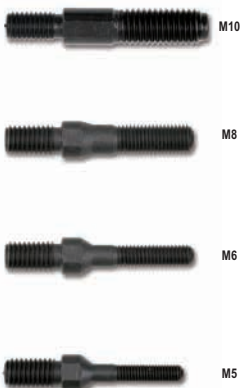

1742A/KR 1 017420111

1742A/C

riveting pliers item 1742A with assortment
of 60 threaded steel insets



1742A/C 1 017420105

	M	Ø mm	n.
1742R-A/M5	5	7	20
1742R-A/M6	6	9	20
1742R-A/M8	8	11	10
1742R-A/M10	10	13	10

536x310x80 mm - 2,1 kg

1743

fitting tool for nylon ties

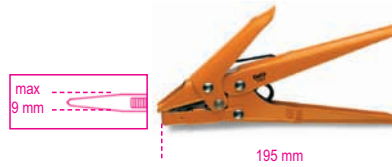

1743 3 017430001

1748/...K

nylon cable ties, self-locking heads

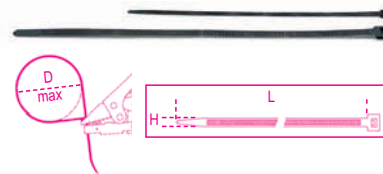

1748/3K 1 017480203

HxL = 2,5x100 mm
D = 18 mm

1748/6K 1 017480206

HxL = 2,5x160 mm
D = 40 mm

1748/7K 1 017480207

HxL = 3,6x150 mm
D = 33 mm

1748/8K 1 017480208

HxL = 3,6x200 mm
D = 46 mm

1748/9K 1 017480209

HxL = 3,6x300 mm
D = 70 mm

1748/14K 1 017480214

HxL = 4,8x190 mm
D = 43 mm

1748/17K 1 017480217

HxL = 4,8x300 mm
D = 72 mm

1748/18K 1 017480218

HxL = 4,8x360 mm
D = 85 mm

1748/23K 1 017480223

HxL = 7,6x300 mm
D = 67 mm

1748/24K 1 017480224

HxL = 7,6x368 mm
D = 88 mm

1748/26K 1 017480226

HxL = 8x430 mm
D = 120 mm

1748B/...K

white nylon clamps

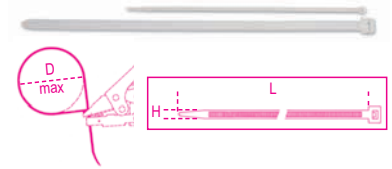

1748B/3K 1 017480303

HxL = 2,5x100 mm
D = 18 mm

1748B/6K 1 017480306

HxL = 2,5x160 mm
D = 40 mm

1748B/7K 1 017480307

HxL = 3,6x150 mm
D = 38 mm

1748B/8K 1 017480308

HxL = 3,6x200 mm
D = 46 mm

1748B/9K 1 017480309

HxL = 3,6x300 mm
D = 70 mm

1748B/14K 1 017480314

HxL = 4,8x190 mm
D = 44 mm

1748B/17K 1 017480317

HxL = 4,8x300 mm
D = 72 mm

1748B/18K 1 017480318

HxL = 4,8x360 mm
D = 86 mm

1748/C5

fitting tool for ties with assortment
of 400 ties



1748/C5 1 017480100

	H mm	L mm	n.
1743			1
1748/2K	2,4	80	100
1748/7K	3,6	140	100
1748/8K	3,6	200	100
1748/14K	4,8	190	100

325x245x55 mm - 850 g

1749

bonding gun varnished metal sheet



1749 2 017490001

1749A

bonding gun, professional model aluminium tube



min 360 mm

1749A	1	017490010
-------	---	-----------

1750B

lever operated grease guns



cc	L mm		
500	380	1	017500205
1000	600	1	017500210

1750R/1 - 1750R/2

spare flexible hose made from nylon



	L mm		
1750R/1	310	2	017500030
1750R/2	410	2	017500040

1750RC

curved rigid hose



1750RC	2	017500050
--------	---	-----------

1750RT

4-jaw grease fitting "Hydraulic" type



1750RT	5	017500110
--------	---	-----------

1750RP/1 - 1750RP/2

heads for flat nozzles

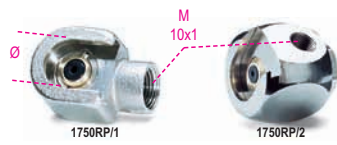

	Ø mm		
1750RP/1	16	2	017500115
1750RP/2	22	2	017500120

1750CG

grease cartridges for item 1750B



cc			
400		18	017500140
600		18	017500160

1751

metal pressure oil cans flexible spout



cc	D mm		
200	62	4	017510002
300	75	4	017510003
500	85	4	017510005
750	100	2	017510007
1000	100	2	017510011

1751R

spare spout for item 1751



cc			
200+1000		5	017510010

1752

plastic pressure cans rigid spouts



cc	D mm		
200	67	4	017520002
300	77	4	017520003
500	95	4	017520005
700	95	2	017520007

1752R

spare spout for item 1752



cc			
200+700		5	017520020

1753

plastic pressure oil cans flexible spouts



cc	D mm		
200	65	4	017530002
300	80	4	017530003
500	95	4	017530005
700	95	2	017530007

1753R

spare spout for item 1753



cc			
200+700		5	017530020

1754

plastic pressure oil cans flexible plastic spouts



cc	D mm		
150	60	5	017540015
250	65	5	017540025

1755

plastic oil bottles retractable spouts



cc	L mm		
30	160	5	017550003
80	170	5	017550008
150	230	5	017550015

1756

pen oiler



cc			
5	140 mm	5	017560001

1756B

pen oiler



cc			
500	280 mm	2	017560220

1757

battery fillers



cc	D mm		
250	60	4	017570002
500	75	4	017570004
1000	90	2	017570006

1757A

battery filler



cc			
2000		1	017570020

1758

plastic funnel



1758		1	017580001

1759A

antifreeze densimeter, glass body



1759A		1	017590001

1759B

acid densimeter, glass body



1759B		1	017590005

1759HD/1

cooling system seal tester



1759HD/1		1	017590052

480x410x110 mm - 3,6 kg

1759M

optical analyzer for coolant and battery fluids

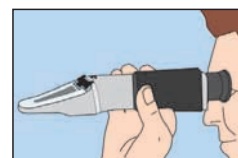

- Instant measurements: battery and freezing point from -3 to -48 °C.
- Liquid battery charge: 1100 g/l to 1400 g/l.
- Supplied with accessories for collecting battery and coolant fluids.
- Measurements are automatically compensated according to temperature.

1759M		1	017590201

1760DGT

digital multi-meter



Technical Data

RPM (tachometer): RPM4 600 - 4000 rpm
 RPM4 600 - 12000 rpm (X10 RPM)
 RPM2/DIS 300 - 4000 rpm
 RPM2/DIS 300 - 6000 rpm (X10 RPM)
 Dwell angle: 4-8 CYL
 DC voltage: 400mV-4/40/400/1000V
 AC voltage: 4/40/400/700V
 DC current: 40/400mA-4/20A
 AC current: 40/400mA-4/20A
 Resistance: 400Ω-4/40/400kΩ-4/40MΩ
 Capacity: 40/400nF-4/40/100μF
 Frequency: 5/50/500Hz-50/500-10MHz
 Duty cycle: 0.1 - 99.9%
 Pulse amplitude: 1- 10ms
 Diode test: Test current 0.3mA typical
 Continuity: <1500Ω - Test current <0.3mA
 Display: High-contrast, backlit 4-digit LCD
 Overvoltage: Category II 1000V
 Auto power off: 30 minutes
 Power supply: 1 9V battery (included)
 Inductive clamp (included)
 2 tips (included)
 Soft cloth case (included)
 Operating manual

1760DGT

1 017600005

1760 400A

amperometric clamp for multimeters



AC/DC

SPECIFICATIONS

Max. current: 400 A
 Frequency: 50/60 Hz
 Power supply: 1 9V battery (included)

1760 400A

1 017600080

1760B

digital multimeter



SPECIFICATIONS

DC voltage: 200 mV-2/20/200/1000V
 AC voltage: 2-20/200/700V
 DC current: 2/20/200 mA-20 A
 AC current: 2/200 mA- 20 A
 Resistance: 200Ω - 2/20/200 kΩ - 2/20 MΩ
 Capacity: 2/20/200 nF - 2/200 μF
 Temperature: -20° + 1000°C/ -4 °F ~ +2000°F
 Frequency: 20kHz
 Power supply: 1 9V battery (included)

1760B

1 017600012

1760/RMS

industrial digital multimeter accurate and sturdy, in a 6-mm co-moulded shell, with antislip, shockproof outer rubber part



Measuring range

AC/DC voltage 110mV - 600V ±0.8% - ±2% rdg
 AC/DC current 110μA - 10A ±1.5% - ±2% rdg
 Resistance 110Ω - 40MΩ ±1.2% - ±2.5% rdg
 Capacity to 11mF 11nF - 40mF ±5% - ±10% rdg (up to 11mF)
 Frequency 1100Hz - 110 MHz ±1.2% - ±1.5% rdg
 Temperature -32°C - +1000°C ±3% - ±5% rdg
 Diode test, 3V DC ±10% rdg
 Continuity test <30 Ω -

1760/RMS

1 017600020

130x80x250 mm

1760PA/AC

amperometric clamp and digital multi-meter



A: AC
V: AC/DC

SPECIFICATIONS

DC voltage 400 mV - 4/40/400/600 V
 AC voltage 400 mV - 4/40/400/600 V
 AC current 40/400/1000 A
 Resistance 400Ω - 4/40/400 kΩ - 4/40 MΩ
 Frequency 5/50/500 Hz - 5/50/500 kHz - 5/10 MHz
 Capacity 40/400 nF - 4/40/100 μF
 Temperature -20 °C + 1000 °C / -4 °F + 1832 °F
 Power supply: 1 9V battery (included)

1760PA/AC

1 017600050



1760PA/AC-DC

amperometric clamp and digital multimeter



CE

A: AC/DC
V: AC/DC

SPECIFICATIONS

DC voltage: 0.1mV ÷ 600V
 AC voltage: 0.1mV ÷ 600V
 AC current: 0.01A ÷ 1000A
 DC current: 0.01A ÷ 1000A
 Resistance: 0.1Ω ÷ 40MΩ
 Capacity: 0.001nF ÷ 40 μF
 Frequency: 0.001kHz ÷ 4kHz
 Temperature: -40°C ÷ 1000 °C
 -40°F ÷ 1832°F



1760PA/AC-DC

1 017600000

1760/TC2

combination contact/non-contact digital tachometer



CE

TECHNICAL DATA

- For measuring:
 - non-contact rotational speed (rpm)
 - contact rotational (rpm)
 - and linear surface speed (m/min or ft/min).
- 5-digit LCD display.
- Scale:
 - non-contact speed 2.5÷99,999 rpm
 - contact speed 0.5÷19,999 rpm
 - linear surface speed 0.05÷1,999.9 m/min.
- Frequency: 0.8 sec.
- Power supply: 4 1.5V batteries, AA size, or 6V power supply unit (not included).
- Supplied with the following:
 - adaptor for contact tip measurement;
 - male (contact) rubber tip (2 pcs.);
 - female (contact) rubber tip (1 pcs.);
 - linear measurement tape (1 pcs.);
 - reflecting tapes;
 - instruction manual;
 - plastic case.



1760/TC2

1 017600161

1760R/TC2

set of reflecting tapes for item 1760/TC2



1760R/TC2

1 017600561

1760/IR800

digital infrared thermometer with dual laser aiming system



CE

TECHNICAL DATA

Range: -50 °C to +800 °C / -58 °F to +1472 °F
 Scale selection: °C/°F
 Accuracy: ±1.0% or ±1.0 °C to 20 °C
 Laser power: <1mW
 Response: 150ms
 Emissivity: 0.10-1.0 adjustable
 Distance ratio: (D:S) 20:1
 Operating temperature: 0 °C ÷ 50 °C / 32 °F ÷ 122 °F
 Operating humidity: 10% to 90% RH
 Backlit LCD display
 Data storage function
 Auto power off
 Power supply: 1 9V battery (included)
 Soft cloth case (included)
 Operating manual



1760/IR800

1 017600380

1760/IR1600

digital infrared thermometer with laser aiming system



CE

TECHNICAL DATA

Range: da -50 °C to +1600 °C / -58 °F to +2912 °F
 Scale selection: °C/°F
 Accuracy: ±1.5% or ±2 °C to 20 °C
 Laser power: <1mW
 Response: 1sec
 Emissivity: 0.10-1.0 adjustable
 Distance ratio: (D:S) 50:1
 Operating temperature: 0 °C ÷ 50 °C / 32 °F ÷ 122 °F
 Operating humidity: 10% to 90% RH
 Backlit LCD display
 Data storage function
 Auto power off
 Power supply: 1 9V battery (included)
 Hard case with aluminium tripod
 Operating manual



1760/IR1600

1 017600460

1760/2TM

two-way digital thermometer



CE

- Two-way type-K thermocouple thermometer
- Backlit LCD display, 42 mm in width, complete with function indicator
- Maximum reading: 9999
- Temperature: Celsius (°C) or Fahrenheit (°F)
- Range: -50°C to 1300°C / -58°F to -2372°F
- Resolution: 1°C or 1°F - 0.1°C or 0.1°F
- Accuracy: 0.5% of maximum and data retention value
- Supplied with: 2 K-type thermocouple sensors
- Soft cloth case
- 1 9V battery (included)
- Operating manual



1760/2TM

1 017600100

Beta



1761

locking wire pliers



1761 1 017610001

1761RS/1

reversible locking wire pliers

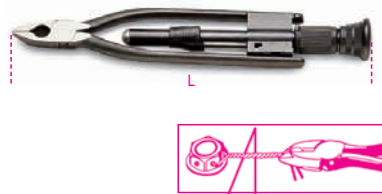

1761RS/1 L ~ 220 1 017610030

1762

revolving punch pliers



Ø mm
2-2,5-3
3,5-4-4,5

2 017620001

1765/C24cases with 24 tools
for pulling out car radios

1765/C24 1 017650001

1766

double suction lifter



max kg
50

1369A/8
2 017660001

1766A

single suction cup



max kg
30

2 017660005

1766CN

ratchet belt



4 m 2 017660010

1766L

lever for glass windows



1766L 1 017660015

1766I

handle for steel cable item 1766G



1766I 2 017660020

1766G

steel cable for glass windows



50 m 1 017660025

1767PMC

magnetic tool holder, round



1767PMC 1 017670020

1767PMR

magnetic tool holder, rectangular



1767PMR 1 017670010

1770extra flat utility knife,
9 mm snap-off blade

1770 10 017700001

1770Autility knife 9 mm with automatic
blade locking mechanism,
2 spare blades

1770A 10 017700025

Beta
Collection

1770RL

9 mm snap-off blades 10 pieces for utility knives 1770 and 1770A



5 017700010

1772H

safety utility knife with retractable blade, spare blade



5 017720029

1774A/RL

10 blades for multifunction scraper item 1774A

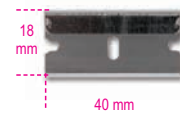

1 017740511

1771

utility knife, 18 mm, supplied with 3 blades



10 017710000

1772RL/2

10 long trapezoidal spare blades, in box, for utility knives, 1772B, 1772J, 1772Y, 1772H, 1774, 1777T

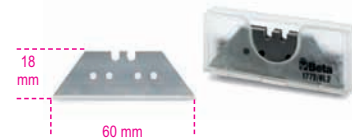

10 017720017

1776A

Multiuse foldaway pliers with leather sheath



1 017760010

1771BM

utility knife, 18 mm, 6 spare blades



10 017710050

1773A

utility knife, 25 mm



10 017730000

1771RL

18 mm snap-off spare blades (10 pieces) for utility knives 1771, 1771BM, 1771F

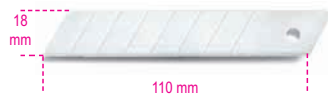

10 017710010

1773RL

25 mm blades (10 pieces) for utility knife 1773



10 017730015

1772B

utility knife with retractable blade, spare blade



10 017720005

1774

multi-function scraper with blade guard



5 017740001

1777T

foldaway knife with trapezoidal stainless steel blade, 5 spare blades



5 017770030

1772Y

utility knife with retractable blade, spare blade



5 017720025

1774A

multifunction scraper, bi-material handle



1 017740011

1778A

foldaway knife stainless steel blade aluminium handle



5 017780001

1778B

foldaway knife stainless steel blade
aluminium handle



1778B 5 017780010

1778C

foldaway knife, stainless steel blade,
handle with wooden insets



1778C 5 017780020

1778M

foldaway knife,
titanium-finished blade,
metallic handle with case



1778M 5 017780040

1778N

foldaway knife, titanium blade,
soft-touch finished handle



1778N 5 017780030

1778X

knives for nautical maintenance, stainless
steel blades, aluminium handles



1778X 2 017780050

1779

self-locking round end knurled
tool made from stainless steel



1779 5 017790001

1781

slim, long blade scissors



1781 5 017810001

1783

light duty scissors



L mm	
215	5 017830021
240	5 017830024

1784

heavy duty scissors



L mm	
175	5 017840017
200	5 017840020
250	5 017840025
300	2 017840030

1808

dual rating soldering iron with steel tips
1824R8



1808 1 018080001

1812E

instant heat soldering iron



1812E 1 018120100

1813E

soldering irons with steel tips item 1824R13



1813E 1 018130100

1814E/30-40

soldering irons with steel tips



	W	
1814E/30	30	1 018140130
1814E/40	40	1 018140140

1820E/50-80

soldering irons with steel tips



	W	
1820E/50	50	1 018200150
1820E/80	80	1 018200180

1822E/200-300

high performance soldering irons



	W	
1822E/200	200	1 018220120
1822E/300	300	1 018220130

1823E

digital soldering station supplied with soldering iron



- Temperature range: from 150°C to 450°C with ±1% accuracy.
- Memory mode designed to save the temperature selected when switching off the station.



1823E 1 018230100

1823E/RS

spare soldering iron for item 1823E



1823E/RS 1 018230130
 1823/RSS 1 018320131

1824R

spare tips for soldering irons



1824R08 1 018240100
 1808
 1824R12 1 018240120
 1812E
 1824R13 1 018240130
 1813E
 1824R14-30 1 018240143
 1814E/30
 1824R14-40 1 018240144
 1814E/40
 1824R20-50 1 018240205
 1820E/50
 1824R20-80 1 018240208
 1820E/80
 1824R22-200 1 018240222
 1822E/200
 1824R22-300 1 018240223
 1822E/300
 1824R23E 1 018240230
 1823E

1827

gas soldering iron, adjustable



1827 1 018270001

1827PC

spare conical tips for item 1827

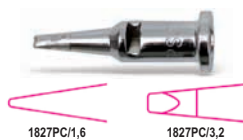

1827PC/1,6 1 018270501
 1827PC/3,2 1 018270502

1827PCL

spare knife tips for item 1827



1827PCL/2,4 1 018270503

1827PFL

spare naked flame tips for item 1827



1827PFL 1 018270504

1827/K

gas soldering iron with 7 accessories in case with soft polyethylene foam base



- Power: 30 watts to 125 watts
- Tip temperature can be adjusted between 250 °C and 500 °C
- Gas flow regulator
- Warm-up time: 15 seconds
- Tank contains gas for 120 minutes' non-stop operation
- Clear tank for monitoring gas level
- Can be refilled with butane gas

1827/K 1 018270100

1830T

desoldering pump with antistatic Teflon® nozzle



1830T 5 018300021

1834/70

high-brightness LED torches, made from sturdy anodized aluminium, up to 70 lumens

- 2xAA batteries not included



1834/70 1 018340010

1834/150

high-brightness LED torches, made from sturdy anodized aluminium, up to 150 lumens

- 3xAAA batteries not included



1834/150 1 018340020

1834/200

high-brightness LED torches, made from sturdy anodized aluminium, up to 200 lumens, double light intensity, with charge indicator

- 3xD batteries (not included)



1834/200 1 018340030

1835

flash light with spare lamp

- Battery: 2x1.5 VR6 (not included)



1835 5 018350001

1837

magnetic, articulated lamp with high-illuminated LEDs, matt aluminium body



1837

1 018370001

1838

rechargeable LED lamp
lithium polymer battery



- Oil and grease resistant
- Hangable, with antislip, shockproof rubber body
- Lithium polymer battery: lightweight, lifetime 8 hours
- 30 high-brightness 100,000-hour LEDs
- Front low-battery LED

No memory effect
100,000-hour LEDs

1838

1 018380001

1840BM

230V inspection lamp,
base type: E27

- Bulb not included



IP20

1840BM

1 018400101

1840WBM

230V inspection lamp,
base type: E27

- Bulb not included



IP65

1840WBM

1 018400120

1841BM

230V inspection lamp
with fluorescent bulb



IP55

1841BM

1 018410101

1841ABM

24V inspection lamp
with fluorescent bulb



IP55

1841ABM

1 018410110

1842BM

LED inspection lamp, 110÷230V



IP55

1842BM

1 018420101

1842ABM

24V LED inspection lamp



IP55

1842ABM

1 018420111

1844/24

automatic cable reel with inspection
lamp and 24 V fluorescent tube

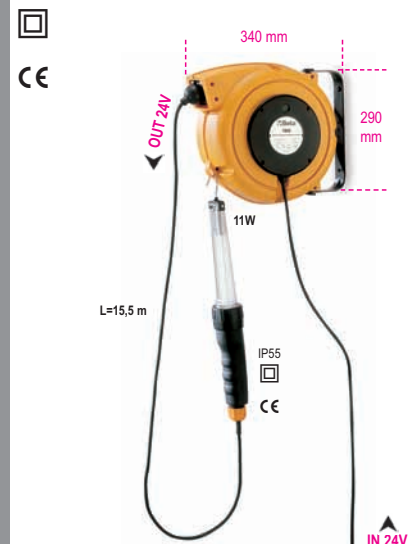

IP42

1844/24

1 018440002



1844/230

automatic cable reel with transformer, 24 V fluorescent tube inspection lamp



IP42

1844/230

1 018440004

1845/230

automatic cable reel with transformer and 230 V incandescent bulb type inspection lamp

• bulb not included

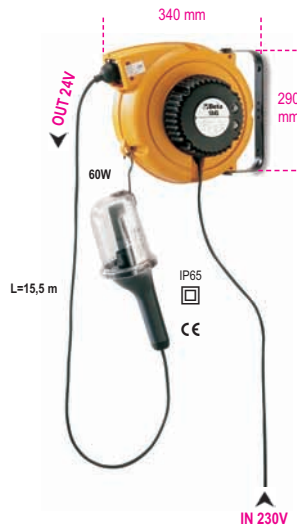

IP42

1845/230

1 018450004

1846R/BM

spare LED lamp for cable reels



IP55

1846 R/BM

1 018460131

1847

combination voltage and continuity tester



IP50
EN 61243-3

TECHNICAL DATA

Voltage range 6÷400 V AC/DC
Frequency range 0÷100 Hz; AC indication with f>2Hz
Peak voltage resistance 4 kV
Input resistance 300 kΩ
Input current I_s <2.5 mA at 400 V
Continuity test <500 kΩ
batteries included

1847

1 018470001

1847K

non-contact detector of AC voltage with LED mini-torch



IP50
EN 61243-3

testing range: 200÷1000 V AC
50/60 Hz

1847K

1 018470101

1850B

heat gun

- Pos. 1 240 l/min. 300° C
- Pos. 2 450 l/min. 500° C
• can be used with gun placed vertically on worktop



1850B

1 018500011

1845/24

automatic cable reel with 24 V incandescent bulb type inspection lamp

• bulb not included

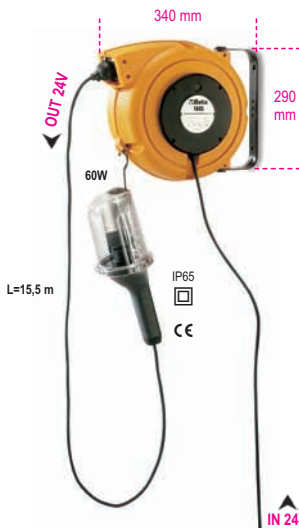

IP42

1845/24

1 018450002

1843R/BM

spare inspection lamp for cable reels, base type E27

• Bulb not included



IP20

1843 R/BM

1 018430131

1843R/WBM

spare inspection lamp for cable reels, base type E27

• Bulb not included



IP65

1843 R/WBM

1 018430132

1844R/BM

spare inspection lamp for cable reels, with fluorescent bulb



IP55

1844 R/BM

1 018440131



1850C

heat gun

- Pos. I 150-250 l/min 50°C
- Pos. II 150-500 l/min 50-650°C

- digital display
- buttons designed to adjust temperature and flow capacity
- can be used with gun placed vertically on a worktop
- 4 preset programmes and possibility to customize other programmes

- Prog 1 250°C ca. 350 l/min
- Prog 2 350°C ca. 400 l/min
- Prog 3 450°C ca. 500 l/min
- Prog 4 550°C ca. 400 l/min



1850C 1 018500015

1850U...

nozzles for items 1850B and 1850C

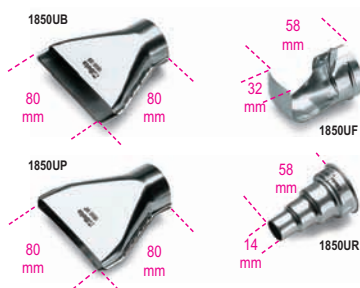

1850UB	B-C	1 018500100
1850UF	B-C	1 018500101
1850UP	B-C	1 018500102
1850UR	C	1 018500103

1851VK

hot glue gun with 12 thermofusibile glue sticks in case

CE



1851VK 1 018510058

1860K/140A

inverter welding machine, suitable for motor generators, compact and easy to carry. Complete with cables, hammer brush, mask and shoulder strap.



Adjustment current: 5-130A
 Power supply: 1x230V
 Absorbed power: MAX 3.0 KVA
 Use factor: 35% - 130 A
 60% - 80 A
 100% - 70 A
 Delayed fuse: 20 A
 Protection: IP23
 Use with generators:
 Operating temperature: -15/+40° C (+5/+104° F)
 Usable electrodes: Ø 1.5 - 3.25mm

1860K/140A 1 018600014

1860K/160A

inverter welding machine, suitable for motor generators, compact and easy to carry. Complete with cables, hammer brush, mask and shoulder strap.



Adjustment current: 5-155A
 Power supply: 1x230V
 Absorbed power: MAX 3.7 KVA
 Use factor: 35% - 150 A
 60% - 130 A
 100% - 100 A
 Delayed fuse: 20 A
 Protection: IP21
 Use with generators:
 Operating temperature: -15/+40° C (+5/+104° F)
 Usable electrodes: Ø 1.5 - 4mm

1860K/160A 1 018600016

1860R/C

cables and clamps for inverter 1860K

1860R/C 1 018600501

1880

manual barrel pump



1880 240 gr 1 018800001

1881

pneumatic barrel pump, ratio 3:1



1881 14 l/min 1 018810001

Beta

2252

seat with castors



2252 O	1	022520001
2252 G	1	022520002
2252 R	1	022520003

2252KR4

spare seat castors



2252KR4	1	022520900
---------	---	-----------

3000M/LT

creeper

• PVC lining with upholstered foamed rubber designed for remarkable comfort

ADJUSTABLE HEAD-REST BY PROGRESSIVE AIR SPRING

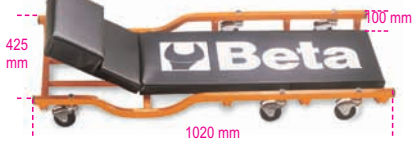

3000M/LT	1	030000220
----------	---	-----------

7,3 kg

3000M/RLS

spare creeper castors



3000M/RLS	1	030000206
-----------	---	-----------

3010/T...

jack stands, pair



C max kg	H min mm	H max mm	H1 mm	L mm	L1 mm
2000	280	425	245	185	165

3010/T2	1	030100002
---------	---	-----------

C max kg	H min mm	H max mm	H1 mm	L mm	L1 mm
3000	285	430	250	180	195

3010/T3	1	030100003
---------	---	-----------

C max kg	H min mm	H max mm	H1 mm	L mm	L1 mm
6000	400	580	340	245	280

3010/T6	1	030100006
---------	---	-----------

C max kg	H min mm	H max mm	H1 mm	L mm	L1 mm
10000	471	735	420	330	290

3010/T10	1	030100010
----------	---	-----------

3011/T

hydraulic bottle jacks



C max kg	H min mm	H max mm	L mm
3500	170	366	86

3011/T3,5	1	030110035
-----------	---	-----------

C max kg	H min mm	H max mm	L mm
5000	203	467	118

3011/T5	1	030110050
---------	---	-----------

C max kg	H min mm	H max mm	L mm
10000	220	484	114

3011/T10	1	030110100
----------	---	-----------

C max kg	H min mm	H max mm	L mm
15000	230	497	113

3011/T15	1	030110150
----------	---	-----------

3012

engine bracket



3012	1	030120010
------	---	-----------

3014

engine stand



3014	1	030140010
------	---	-----------

Beta

Beta

INSULATED TOOLS

Beta Utensili's insulated tools are meant to guarantee installation and electrical maintenance men's safety. All of the insulated tools make it possible to work on systems up to 1000V on alternating current and up to 1500V on direct current. To provide the highest quality and performance standards and verify fitness and compliance with EN 60900, each tool is subjected to the following stringent tests: handle resistance to slipping and flame propagation, and high voltage test (10000V).

For assortments and thermoformed trays, see relevant sections.



52MQ

single open end wrenches



EN 60900

mm	L mm	
10	110	2 000520110
11	120	2 000520111
12	132	2 000520112
13	140	2 000520113
14	146	2 000520114
15	166	2 000520115
17	168	2 000520117
19	176	2 000520119
22	200	2 000520122
24	225	2 000520124

89MQ

single ring wrenches



EN 60900

mm	L mm	
10	170	2 000890110
11	180	2 000890111
12	190	2 000890112
13	195	2 000890113
14	200	2 000890114
15	210	2 000890115
17	218	2 000890117
19	240	2 000890119
22	255	2 000890122
24	280	2 000890124

110MQ

adjustable wrench with scale



EN 60900

L mm	A max	
250	30	3 001100525

606MQ/50

click-type torque wrench with reversible ratchet



EN 60900
UNI EN 26789
ISO 6789

Nm	Kgfm	lbf.ft	A mm	L mm	g
5÷50	0,5÷5	4÷40	90	375	1130

606MQ/50	1 006060705
----------	-------------

920MQ/A

hexagon sockets



EN 60900

mm	D mm	L mm	
10	21,5	57	2 009200240
11	21,5	57	2 009200241
12	23,0	57	2 009200242
13	23,0	57	2 009200243
14	23,0	57	2 009200244
17	30,0	57	2 009200247
19	32,2	57	2 009200249
22	36,0	57	2 009200252
24	39,0	57	2 009200254

920MQ/21

1/2" square drive extension bar



EN 60900

L mm	D mm	
135	28	2 009200804

920MQ/22

1/2" square drive extension bar



EN 60900

L mm	D mm	
264	30	2 009200805

920MQ/T

1/2" square drive, T-handle



EN 60900

L mm	200	2 009200807
------	-----	-------------

920MQ/55A

1/2" square drive reversible ratchet with socket locking system

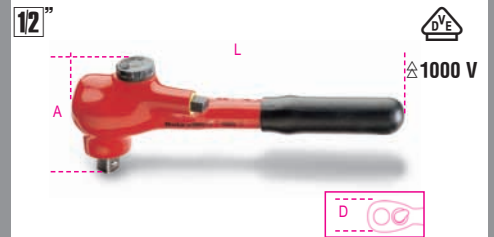

EN 60900

L mm	D mm	A mm	
240	50	89	1 009200809

920MQ/C16

9 hexagon sockets, 3 T-handle wrenches with hexagon male ends and 4 accessories



EN 60900

920MQ/C16

1 009200918

920MQ/A	10 - 11 - 12 - 13 - 14 17 - 19 - 22 - 24 mm
920MQ/21	135 mm
920MQ/22	264 mm
920MQ/55A	
920MQ/T	
951MQ	5 - 6 - 8 mm

420x280x60 mm - 5500 g

943MQ

hexagon nut spinners with handles



EN 60900

mm	L mm	L1 mm	
5,5	233	125	2 009430962
6	233	125	2 009430963
7	240	125	2 009430964
8	240	125	2 009430965
10	252	125	2 009430967
13	257	125	2 009430968



943MQ/S6
5,5-6-7-8-10-13 mm

1 009430970

951MQ

T-handle wrenches with hexagon male ends



1000 V

EN 60900

mm	L mm	
4	165	2 009510704
5	170	2 009510705
6	168	2 009510706
8	165	2 009510708

993MQ

bent knurled point spring tweezers



1000 V

EN 60900

L mm	
147	2 009930040

994MQ

straight knurled point spring tweezers



1000 V

EN 60900

L mm	
145	2 009940040

1010MQ

long round nose pliers

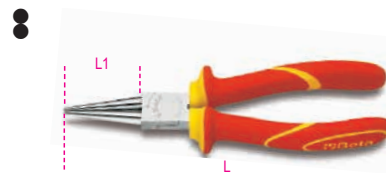

1000 V

EN 60900

L ~	L1 mm	
160	51,5	2 010100096

1082MQ

diagonal cutting nippers



1000 V

EN 60900

L ~	L1 mm	mm	
140	20	1,6	3 010820094
160	22	1,6	3 010820096

1084MQ

heavy duty diagonal cutting nippers



1000 V

EN 60900

L ~	L1 mm	mm	
200	26	2,0	2 010840100

1088MQ

end cutting nippers



1000 V

EN 60900

L ~	L1 mm	mm	
160	7	1,6	3 010880096

1132MQ

cable cutter with insulated handles for copper and aluminium cables



1000 V

EN 60900

L ~	mm	
230	17	2 011320193

1142MQ

wire stripping pliers



1000 V

EN 60900

L mm	mm ²	
160	0,5÷6	3 011420096

1150MQ

combination pliers, bright chrome-plated



1000 V

EN 60900

L ~	L1 mm	mm	
160	37	1,6	3 011500096
180	39	1,8	3 011500098
200	43	2,0	3 011500100
220	46	2,0	2 011500102

1162MQ

extra long flat nose pliers



1000 V

EN 60900

L ~	L1 mm	mm	
160	56	1,6	3 011620096
200	76	1,6	3 011620100

1166MQ

extra long needle nose pliers



1000 V

EN 60900

L ~	L1 mm	mm	
160	56	1,6	3 011660096
200	76	1,6	3 011660100

1168MQ

extra long bent needle nose pliers



EN 60900

L	L1	mm	
160	50	1,6	3 011680096
200	70	1,6	3 011680100

1272MQ

screwdrivers
for cross head Phillips® screws



EN 60900

PHxDxL	L1	
0x3x60	156	3 012720903
1x4,5x80	188	3 012720909
2x6x100	215	3 012720918
3x8x150	283	2 012720924
4x10x200	333	2 012720927



1272MQ/S5	
PH0x3x60-PH1x4,5x80	1 012720951
PH2x6x100-PH3x8x150	
PH4x10x200 mm	

1273MQ/D6

set of 6 screwdrivers



EN 60900

1273MQ/D6	
1274MQ	0,5x3x100 -0,8x4x100 1,0x5,5x125 mm
1272MQ	PH0x3x60 -PH1x4,5x80 PH2x6x100 mm

1274MQ

screwdrivers for headless slotted screws

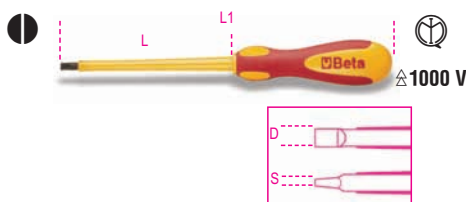

EN 60900

SxDxL	L1	
0,4x2,5x75	171	5 012740900
0,5x3x100	196	5 012740903
0,8x4x100	208	5 012740906
1x5,5x125	240	5 012740909
1,2x6,5x150	277	5 012740912
1,2x8x175	307	2 012740915
1,6x10x200	332	2 012740918



1274MQ/S6	
0,5x3x100-0,8x4x100	1 012740951
1x5,5x125-1,2x6,5x150	
1,2x8x175-1,6x10x200 mm	

1279MQ

screwdrivers for cross head
Pozidriv®-Supadriv® screws



EN 60900

PZ	L	L1	
0	60	156	3 012790903
1	80	188	3 012790909
2	100	215	3 012790918
3	150	282	3 012790924



1279MQ/S4	
PZ 0-1-2-3	1 012790951

1725MQ

mini-hacksaw frame



EN 60900

1725MQ	2 017250030
--------	-------------

1777MQ/C

cable stripping knife, insulated

• for multicore cables



1777MQ/C	1 017770026
----------	-------------

1777MQ/U

cable stripping knife, insulated



1777MQ/U	1 017770011
----------	-------------

1777RL/U

spare blade for utility knife 1777MQ/U



1777RL/U	1 017770021
----------	-------------

1995MQ/T

insulating mat



VDE 680/Part.1

1995MQ/T	1 019950030
----------	-------------

1995MQ/G1 - G2

insulating gloves in latex



EN 60903

	Gr.	
1995MQ/G1	9	1 019950010
1995MQ/G2	10	1 019950013



SPARK-PROOF TOOLS

COPPER-BERILLIUM
CU-BE



The **Beta** spark-proof tools are specially designed for safe operations in environments subject to potential risk of explosion, in the presence of flammable liquids or gases, or for any applications that require using perfectly antimagnetic, corrosion-resistant tools.

Composition	Be	1,8 ÷ 2,3 %
	Co+Ni	Min. 0.2 %
	Co+Ni+Fe	Max. 1.2 %
	Cu	Compensating
Hardness	310 ÷ 360 Brinell	
Tensile strength	1050 ÷ 1200 N/mm ²	
Yield point	840 ÷ 880 N/mm ²	

31BA

spark-proof punches,
made from copper-beryllium alloy



Ø mm	L mm		
8	150	1	000310808
10	150	1	000310810
12	150	1	000310812

34BA

spark-proof flat chisels,
made from copper-beryllium alloy



L mm	A mm		
200	22	1	000340801
300	24	1	000340802

39BA

spark-proof wedges,
made from copper-beryllium alloy



L mm	A mm		
150	40	1	000390801
230	40	1	000390802

42BA

spark-proof combination wrenches,
open bi-hex ring ends,
made from copper-beryllium alloy



Ø mm	L mm		
6x6	105	1	000420806
7x7	105	1	000420807
8x8	120	1	000420808
9x9	120	1	000420809
10x10	135	1	000420810
11x11	135	1	000420811
12x12	150	1	000420812
13x13	150	1	000420813
14x14	175	1	000420814
15x15	175	1	000420815
16x16	195	1	000420816
17x17	200	1	000420817
19x19	220	1	000420819
20x20	230	1	000420820
21x21	240	1	000420821
22x22	250	1	000420822
24x24	268	1	000420824
27x27	290	1	000420827
30x30	313	1	000420830
32x32	333	1	000420832
36x36	355	1	000420836

Ø mm	L mm		
38x38	430	1	000420838
41x41	430	1	000420841
46x46	480	1	000420846
50x50	520	1	000420850
55x55	560	1	000420855
60x60	580	1	000420860

42BA/AS

spark-proof combination wrenches,
open bi-hex ring ends,
made from copper-beryllium alloy



Ø mm	L mm		
3/8x3/8	128	1	000420950
7/16x7/16	135	1	000420951
1/2x1/2	140	1	000420953
9/16x9/16	163	1	000420954
5/8x5/8	177	1	000420956
11/16x11/16	195	1	000420957
3/4x3/4	215	1	000420959
13/16x13/16	230	1	000420961
7/8x7/8	235	1	000420962
15/16x15/16	256	1	000420964
1x1	266	1	000420965
1.1/16x1.1/16	283	1	000420967
1.1/8x1.1/8	297	1	000420969
1.3/16x1.3/16	308	1	000420970
1.1/4x1.1/4	324	1	000420973

55BA

spark-proof double open end wrenches
made from copper-beryllium alloy



Ø mm	L mm		
6x7	90	1	000550801
8x9	100	1	000550802
10x11	120	1	000550803
12x13	130	1	000550804
14x15	145	1	000550805
16x17	165	1	000550807
18x19	170	1	000550809
20x22	185	1	000550811
21x23	210	1	000550813
22x24	210	1	000550815
24x26	230	1	000550817
24x27	230	1	000550818
25x28	230	1	000550819
27x29	246	1	000550820
30x32	265	1	000550822
36x38	320	1	000550826
41x46	355	1	000550829

78BA

spark-proof bi-hex ring slogging wrenches,
made from copper-beryllium alloy



Ø mm	L mm		
24	140	1	000780824
27	155	1	000780827
30	165	1	000780830
32	180	1	000780832
34	192	1	000780834
36	208	1	000780836
38	215	1	000780838
41	225	1	000780841
46	245	1	000780846
50	250	1	000780850
55	265	1	000780855
60	275	1	000780860
65	295	1	000780865
70	310	1	000780870
75	325	1	000780875
80	340	1	000780880

78BA/AS

spark-proof bi-hex ring slogging wrenches,
made from copper-beryllium alloy



Ø mm	L mm		
1.1/4	177	1	000780910
1.7/16	208	1	000780912
1.5/8	225	1	000780914
1.13/16	243	1	000780916
2	254	1	000780918
2.3/16	264	1	000780920
2.3/8	275	1	000780922
2.9/16	286	1	000780924
2.15/16	311	1	000780926
3.1/8	325	1	000780928
3.1/2	355	1	000780930

89BA

spark-proof single ring wrenches,
made from copper-beryllium alloy



Ø mm	L mm		
10	200	1	000890810
11	210	1	000890811
12	220	1	000890812
13	230	1	000890813
14	240	1	000890814
16	260	1	000890816
17	270	1	000890817
18	280	1	000890818
19	300	1	000890819
20	310	1	000890820
22	330	1	000890822
24	350	1	000890824
27	370	1	000890827
30	400	1	000890830
32	420	1	000890832

90BA

spark-proof double ended offset ring wrenches, made from copper-beryllium alloy



mm	L mm		
10x11	155	1	000900803
12x13	175	1	000900806
14x17	220	1	000900809
16x18	235	1	000900812
18x19	265	1	000900815
20x22	295	1	000900818
22x24	315	1	000900821
24x27	340	1	000900823
30x32	395	1	000900824
34x36	410	1	000900826

96BA

spark-proof offset hexagon key wrenches, made from copper-beryllium alloy



mm	L mm	L1 mm		
2	50	16	1	000960762
3	63	21	1	000960763
4	69	25	1	000960764
5	78	29	1	000960765
6	88	33	1	000960766
7	93	34	1	000960767
8	97	36	1	000960768
9	104	37	1	000960769
10	110	39	1	000960770
12	122	44	1	000960772

110BA

spark-proof adjustable wrenches, made from copper-beryllium alloy



L mm	A max mm		
200	24	1	001100820
250	32	1	001100825
300	39	1	001100830
375	48	1	001100837

363BA

spark-proof heavy duty pipe wrenches, made from copper-beryllium alloy



L mm	Ø max mm	Ø max mm		
250	1" gas	34	1	003630825
300	1 1/2" gas	49	1	003630830
350	2" gas	60	1	003630835
450	2 1/2" gas	76	1	003630845
600	3" gas	90	1	003630860

386BA

spark-proof heavy duty reversible chain pipe wrenches, made from copper-beryllium alloy



Ø max mm	L mm		
100	600	1	003860806
200	900	1	003860809

921BA

spark-proof bi-hex sockets, made from copper-beryllium alloy

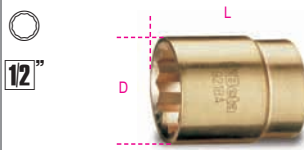

mm	D mm	L mm		
10	16,5	40	1	009210810
11	17,5	40	1	009210811
12	18,5	40	1	009210812
13	19,5	40	1	009210813
14	20,0	40	1	009210814
15	21,5	40	1	009210815
16	24,0	40	1	009210816
17	25,0	40	1	009210817
18	25,0	40	1	009210818
19	28,0	42	1	009210819
20	29,0	42	1	009210820
21	30,0	43	1	009210821
22	30,5	43	1	009210822
24	34,0	43	1	009210824
25	36,0	43	1	009210825
26	37,5	43	1	009210826
27	37,5	45	1	009210827
28	38,9	46	1	009210828
30	41,5	46	1	009210830
32	43,5	46	1	009210832

921BA/50

spark proof 1/2" drive push-through square ratchet made from copper-beryllium alloy



L mm	D mm	A mm		
250	45	16,5	1	009210850

963BA

pry bar with pointed and flat bent ends, made from copper-beryllium alloy



L mm	A mm		
500	24	1	009630801

964BA

spark-proof wrench bungs, made from copper-beryllium alloy



L mm			
385		1	009640801

966BA

spark-proof safety valve wrench, made from copper-beryllium alloy

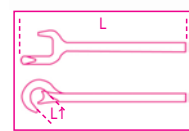

L mm	L1 mm		
350	40	1	009660801

1046BA

spark-proof slip joint pliers, made from copper-beryllium alloy



L mm	A max mm		
250	32	1	010460801

1082BA

spark-proof diagonal cutting nippers, made from copper-beryllium alloy



L mm	L1 mm		
160	22	1	010820801

1150BA

spark-proof combination pliers,
made from copper-beryllium alloy

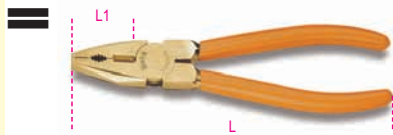

L mm	L1 mm		
200	40	1	011500820

1270BA

spark-proof screwdrivers
for slotted head screws,
made from copper-beryllium alloy



AxL mm	L1 mm		
4x100	209	1	012700804
6x150	270	1	012700806
10x250	382	1	012700810

1272BA

spark-proof screwdrivers
for slotted head Phillips® screws,
made from copper-beryllium alloy



PHxDxL mm	L1 mm		
1x5x100	209	1	012720801
2x6x150	270	1	012720802
3x8x200	332	1	012720803

1370BA

spark-proof engineer's hammers,
made from copper-beryllium alloy
wooden shafts



g	L1 mm	L mm		
500	108	310	1	013700805
1000	137	340	1	013700810

1370BA/MR

spare shafts for item 1370BA

1370BA/MR500 1370BA/500	1	013700865
1370BA/MR1000 1370BA/1000	1	013700870

1379BA

spark-proof scraping hammer,
made from copper-beryllium alloy
wooden shaft



g	L1 mm	L mm		
500	142	315	1	013790850

1380BA

spark-proof lump hammers,
made from copper-beryllium alloy
wooden shafts



g	L1 mm	L mm		
1500	118	397	1	013800815
2000	126	449	1	013800820

1380BA/MR

spare shaft for item 1380BA

1380BA/MR1500 1380BA/1500	1	013800865
1380BA/MR2000 1380BA/2000	1	013800870

1381BA

spark-proof sledge hammer,
made from copper-beryllium alloy
wooden shaft

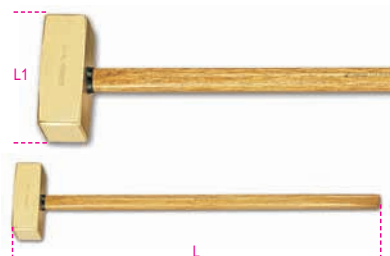

g	L1 mm	L mm		
5000	179	900	1	013810850

1381BA/MR

spare shafts for item 1381BA

1381BA/MR5000 1381BA/5000	1	013810870
------------------------------	---	-----------

1717BA

spark-proof rigid spatulas,
made from copper-beryllium alloy



A mm		
60	1	017170801
80	1	017170803

1717BA/1

spark-proof wall scraper,
made from copper-beryllium alloy



1717BA/1	1	017170805
----------	---	-----------

1727BA

spark-proof hacksaw and blade,
made from copper-beryllium alloy



1727BA	1	017270801
--------	---	-----------

1728BA

spark-proof blades for hacksaw frames,
made from copper-beryllium alloy



1728BA	1	017280801
--------	---	-----------

1737BA

brush with spark-proof wires,
made from copper-beryllium alloy



A mm		
29	1	017370801

1776BA

spark-proof knife,
made from copper-beryllium alloy



1776BA	1	017760801
--------	---	-----------

PNEUMATIC

For over ten years Beta Utensili has been consolidating its expertise in the pneumatic tool industry, developing a comprehensive range of products for the automotive and industrial maintenance markets.

The range includes several accessories for air treatment with FRL units, ¼" to ½", and tool supply with a wide choice of PU hoses and quick couplers.



Beta

1921B1

baby reversible air ratchet

1/4"

CE



Free speed	350 rpm
Max. torque	24 Nm
Working pressure	6.2 bars
Mean air consumption	68 l/min
Internal hose size (Ø)	8 mm
Bolt capacity	Cl 8.8 M7 ● 11 mm
Bolt capacity	Cl 12.9 M6 ● 10 mm

1/4	450	1	019210001
-----	-----	---	-----------

1921M1

compact reversible air ratchet

1/4"

CE



Free speed	200 rpm
Max. torque	27 Nm
Working pressure	6.2 bars
Mean air consumption	96 l/min
Internal hose size (Ø)	8 mm
Bolt capacity	Cl 8.8 M7 ● 11 mm
Bolt capacity	Cl 12.9 M6 ● 10 mm

1/4	640	1	019210005
-----	-----	---	-----------

1921M2

compact reversible air ratchet

3/8"

CE



Free speed	200 rpm
Max. torque	27 Nm
Working pressure	6.2 bars
Mean air consumption	96 l/min
Internal hose size (Ø)	8 mm
Bolt capacity	Cl 8.8 M7 ● 11 mm
Bolt capacity	Cl 12.9 M6 ● 10 mm

3/8	640	1	019210015
-----	-----	---	-----------

1921N3

reversible ratchet

1/2"

CE



Free speed	150 rpm
Max. torque	68 Nm
Working pressure	6.2 bars
Mean air consumption	140 l/min
Internal hose size (Ø)	10 mm
Bolt capacity	Cl 8.8 M10 ● 16 mm
Bolt capacity	Cl 12.9 M8 ● 13 mm

1/2	1,22	1	019210025
-----	------	---	-----------

1924A

compact reversible impact wrench

• "Pin Clutch" impulse device

3/8"

CE



Free speed	10,000 rpm
Max. torque	298 Nm
Working pressure	6.2 bars
Mean air consumption	95 l/min
Internal hose size (Ø)	8 mm
Bolt capacity	Cl 8.8 M16 ● 24 mm
Bolt capacity	Cl 12.9 M14 ● 21 mm

3/8	1,5	1	019240011
-----	-----	---	-----------

1924CD

reversible impact wrench, made from composite material

• Double hammer impulse device

3/8"

CE



Free speed	10,000 rpm
Max. torque	410 Nm
Operating torque	250 Nm
Air inlet	1/4" GAS
Working pressure	6.2 bar
Mean air consumption	79 l/min
Internal hose Ø	8 mm
Bolt capacity	Cl 8.8 M16 ● 24mm
Bolt capacity	Cl 12.9 M14 ● 21mm

3/8	1,25	1	019240007
-----	------	---	-----------

1927MCD

reversible impact wrench, made from composite material

• Double hammer impulse device

1/2"

CE



Free speed	12,000 rpm
Max. torque	434 Nm
Working pressure	6.2 bars
Mean air consumption	79 l/min
Internal hose size (Ø)	10 mm
Bolt capacity	Cl 8.8 M20 ● 30 mm
Bolt capacity	Cl 12.9 M16 ● 24 mm

1/2	1,25	1	019270027
-----	------	---	-----------



1927CD

reversible impact wrench, made from composite material

- Double hammer impulse device



Free speed	7,000 rpm
Max. torque	1020 Nm
Operating torque	610 Nm
Air inlet	1/4" GAS
Working pressure	6.2 bar
Mean air consumption	130 l/min
Internal hose Ø	8 mm
Bolt capacity	CL 8.8 M22●34mm CL 12.9 M18●27mm

■	⚖	📦	📄
1/2	1,9	1	019270007

1927DA

reversible impact wrench

- Double hammer impulse device



Free speed	7,000 rpm
Max. torque	650 Nm
Working pressure	6.2 bars
Mean air consumption	155 l/min
Internal hose size (Ø)	10 mm
Bolt capacity	CL 8.8 M22●34 mm CL 12.9 M18●27 mm

■	⚖	📦	📄
1/2	2,7	1	019270033

1927K4

assortment of one reversible impact wrench and four impact sockets, long series

- "Pin Clutch" impulse device



Free speed	7,000 rpm
Max. torque	610 Nm
Working pressure	6.2 bars
Mean air consumption	175 l/min
Internal hose size (Ø)	10 mm
Bolt capacity	CL 8.8 M22●34 mm CL 12.9 M18●27 mm
Bolt capacity	2,7 Kg

■	⚖	📦	📄
1/2	4,65	1	019270104

1927A

reversible impact wrench

- "Pin Clutch" impulse device



Free speed	7000 rpm
Max. torque	610 Nm
Working pressure	6.2 bar
Mean air consumption	160 l/min
Ø internal hose size	10 mm
Bolt capacity	CL 8.8 M22●34 mm CL 12.9 M18●27 mm

■	⚖	📦	📄
1/2	2,7	1	019270002

1926SD

silenced impact wrench

- Double hammer impulse device



Free speed	7000 rpm
Max. torque	610 Nm
Working pressure	6.2 bars
Mean air consumption	180 l/min
Ø internal hose size	10 mm
Bolt capacity	CL 8.8 M22●34 mm CL 12.9 M18●27 mm

■	⚖	📦	📄
1/2	2,6	1	019260009

1928CD

reversible impact wrench, made from composite material

- Double hammer impulse device



Free speed	4,500 rpm
Max. torque	1,800 Nm
Operating torque	1,290 Nm
Air inlet	3/8" GAS
Working pressure	6.2 bar
Mean air consumption	215 l/min
Internal hose Ø	10 mm
Bolt capacity	CL 8.8 M27●41mm CL 12.9 M22●34mm

■	⚖	📦	📄
3/4	3,5	1	019280007

1928DA

reversible impact wrench

- Double hammer impulse device



Free speed	5,000 rpm
Max. torque	1695 Nm
Working pressure	6.2 bars
Mean air consumption	240 l/min
Internal hose size (Ø)	10 mm
Bolt capacity	Cl 8.8 M27 ● 41 mm
Bolt capacity	Cl 12.9 M24 ● 36 mm

3/4	4,3	1	019280022
-----	-----	---	-----------

1930CD

reversible impact wrench, made from composite material

- Double hammer impulse device



Free speed	4000 rpm
Max. torque	2445 Nm
Working pressure	6.2 bar
Mean air consumption	320 l/min
Internal hose Ø	13 mm
Bolt capacity	Cl 8.8 M36 ● 55 mm
Bolt capacity	Cl 12.9 M30 ● 46 mm

1	7,1	1	019300022
---	-----	---	-----------

1930HCD

reversible impact wrench, made from composite material

- Double hammer impulse device



Free speed	4000 rpm
Max. torque	2711 Nm
Working pressure	6.2 bar
Mean air consumption	350 l/min
Internal hose Ø	13 mm
Bolt capacity	Cl 8.8 M39 ● 60 mm
Bolt capacity	Cl 12.9 M33 ● 50 mm

1	10,2	1	019300028
---	------	---	-----------

1928K4

assortment of one reversible impact wrench and four impact sockets, long series

- "Pin Clutch" impulse device



Free speed	4,000 rpm
Max. torque	1493 Nm
Working pressure	6.2 bars
Mean air consumption	260 l/min
Internal hose size (Ø)	10 mm
Bolt capacity	Cl 8.8 M27 ● 41 mm
Bolt capacity	Cl 12.9 M24 ● 36 mm
Peso avvitatore	5,2 Kg

3/4	9,3	1	019280104
-----	-----	---	-----------

1930NCD

reversible impact wrench, made from composite material

- Double hammer impulse device



Free speed	4000 rpm
Max. torque	2445 Nm
Working pressure	6.2 bar
Mean air consumption	320 l/min
Internal hose Ø	13 mm
Bolt capacity	Cl 8.8 M36 ● 55 mm
Bolt capacity	Cl 12.9 M30 ● 46 mm

1	8,75	1	019300027
---	------	---	-----------

1930PA

reversible impact wrench

- Double hammer impulse device



Free speed	3500 rpm
Max. torque	2445 Nm
Working pressure	6.2 bars
Mean air consumption	350 l/min
Ø internal hose size	13 mm
Bolt capacity	Cl 8.8 M36 ● 55 mm
Bolt capacity	Cl 12.9 M30 ● 46 mm

1	9,6	1	019300032
---	-----	---	-----------

1930ND

reversible impact wrench

• Double hammer impulse device

1"

CE

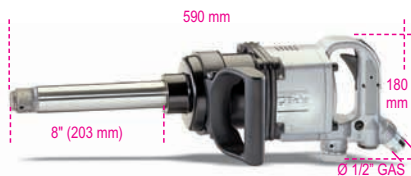

Free speed	3800 rpm
Max. torque	2500 Nm
Working pressure	6,2 bars
Mean air consumption	340 l/min
Ø internal hose size	13 mm
Bolt capacity	CI 8.8 M36 ● 55 mm
Bolt capacity	CI 12.9 M30 ● 46 mm

■	kg	1	14
■	g	1	019300008

1930DL

reversible impact wrench

• Double hammer impulse device

1"

CE

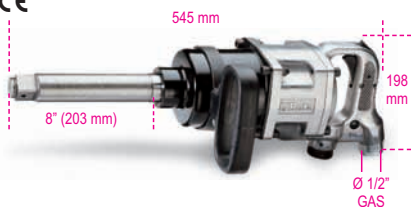

Free speed	4200 rpm
Max. torque	2445 Nm
Working pressure	6,2 bars
Mean air consumption	560 l/min
Ø internal hose size	13 mm
Bolt capacity	CI 8.8 M36 ● 55 mm
Bolt capacity	CI 12.9 M30 ● 46 mm

■	kg	1	10,5
■	g	1	019300007

1931CD6

reversible drill, made from composite material

CE

CE



Chuck capacity	1÷6 mm
Spindle thread	3/8" - 24UNF
Free speed	2,600 rpm
Power	0.23 kW
Working pressure	6.2 bars
Mean air consumption	130 l/min
Internal hose size (Ø)	8 mm

■	g	1	019310006
■	g	590	

1931CD10

reversible drill, made from composite material

CE

CE



Chuck capacity	1÷10 mm
Spindle thread	3/8" - 24UNF
Free speed	1,800 rpm
Power	0.38 kW
Working pressure	6.2 bars
Mean air consumption	170 l/min
Internal hose size (Ø)	10 mm

■	Kg	1,01	
■	g	1	019310010

1931CD13

reversible drill, made from composite material

CE

CE



Chuck capacity	1÷13 mm
Spindle thread	1/2" - 20UNC
Free speed	800 rpm
Power	0.38 kW
Working pressure	6.2 bars
Mean air consumption	170 l/min
Internal hose size (Ø)	10 mm

■	Kg	1,29	
■	g	1	019310013

1931AN10

reversible angle drill

CE

CE



Chuck capacity	1÷10 mm
Spindle thread	3/8" - 24UNF
Free speed	1,400 rpm
Power	0.38 kW
Working pressure	6.2 bars
Mean air consumption	150 l/min
Internal hose size (Ø)	10 mm

■	Kg	1,05	
■	g	1	019310030

1932B10

reversible drill



Chuck capacity 1±10 mm
Spindle thread 3/8" - 24UNF
Free speed 1,800 rpm
Power 0.44 kW
Working pressure 6.2 bars
Mean air consumption 160 l/min
Internal hose size (Ø) 10 mm



1,15



1 019320040

1932RS13

reversible drill



Chuck capacity 1.5±13 mm
Spindle thread 1/2" - 20UNC
Free speed 750 rpm
Power 0.55 kW
Working pressure 6.2 bars
Mean air consumption 160 l/min
Internal hose size (Ø) 10 mm



1,4



1 019320043

1933

die grinder



Chuck capacity 3 - 6 mm
Free speed 25,000 rpm
Power 0.20 kW
Working pressure 6.2 bars
Mean air consumption 230 l/min
Internal hose size (Ø) 10 mm



380



1 019330001

1933I

die grinder



Chuck capacity 3 - 6 mm
Free speed 20,000 rpm
Power 0.38 kW
Working pressure 6.2 bars
Mean air consumption 220 l/min
Internal hose size (Ø) 10 mm



670



1 019330005

1933L

long spindle die grinder



Chuck capacity 3 - 6 mm
Free speed 25,000 rpm
Power 0.20 kW
Working pressure 6.2 bars
Mean air consumption 230 l/min
Internal hose size (Ø) 10 mm



670



1 019330015

1933AN90

angle grinder



Chuck capacity 3 - 6 mm
Free speed 20,000 rpm
Power 0.20 kW
Working pressure 6.2 bars
Mean air consumption 230 l/min
Internal hose size (Ø) 10 mm



510



1 019330020

1935E

reversible air screwdriver



Free speed 1,800 rpm
Torque range 12 Nm
Working pressure 6.2 bars
Mean air consumption 150 l/min
Internal hose size (Ø) 10 mm
Screw capacity 6-9 M
Bit holder ● 1/4"



1,3



1 019350040

1935F

reversible air screwdriver



Free speed	800 rpm
Torque range	16 Nm
Working pressure	6.2 bars
Mean air consumption	150 l/min
Internal hose size (Ø)	10 mm
Screw capacity	6-9 M
Bit holder	● 1/4"

Kg		
1,15	1	019350045

1936/5P

angle grinder, made from composite material



Grinding disc size	125 mm
Spindle thread	M14
Free speed	10,000 rpm
Power	0.51 Kw
Working pressure	6.2 bars
Mean air consumption	350 l/min
Internal hose size (Ø)	10 mm

Kg		
1,78	1	019360035

1936/5

angle grinder



Grinding disc size	125 mm
Spindle thread	M14
Free speed	12000 rpm
Power	0,7 Kw
Working pressure	6,2 bars
Mean air consumption	380 l/min
Ø internal hose size	10 mm

Kg		
1,98	1	019360005

1936/7

angle grinder



Grinding disc size	178 mm
Spindle thread	M14
Free speed	7000 rpm
Power	1,4 Kw
Working pressure	6,2 bars
Mean air consumption	500 l/min
Ø internal hose size	13 mm

Kg		
3,4	1	019360007

1940

air hammer



Chisel inlet	○ 11 mm
Piston size	19 mm
Piston stroke	67 mm
Strokes per minute	3500
Working pressure	6,2 bars
Mean air consumption	240 l/min
Ø internal hose size	8 mm

Kg		
1,92	1	019400001

1940MT

spare retainer spring for item 1940



1940MT	5	019400110
--------	---	-----------

1940HD

air hammer



Chisel inlet	○ 11 mm
Piston size	19 mm
Piston stroke	58 mm
Strokes per minute	3000
Working pressure	6,2 bars
Mean air consumption	280 l/min
Ø internal hose size	8 mm

Kg		
1,86	1	019400002

1940MT/HD

spare retainer spring for item 1940HD



1940MT/HD 5 019400111

1940S...

chisels for air hammers
items 1940 and 1940HD



1940SN	5	019400020
1940ST	5	019400021
1940SD	5	019400022
1940SPS	5	019400023
1940SDT	5	019400024

1940/S5

set of 5 chisels for air hammers
items 1940 and 1940HD



1940/S5 1 019400030

1942

air saw

CE



Strokes per minute	5000
Stroke length	10 mm
Working pressure	6,2 bars
Mean air consumption	200 l/min
Ø internal hose size	6 mm

1,05 kg 1 019420001

1942S

silenced air saw

CE



Strokes per minute	9000
Stroke length	10 mm
Working pressure	6,2 bars
Mean air consumption	210 l/min
Ø internal hose size	8 mm

700 g 1 019420002

1942LR

Bimetal blades, 32 teeth
for air saw item 1942 and 1942S



1942LR 5 019420032

1944

needle scaler

CE



Ø Needle size	3 mm
Stroke length	33 mm
Strokes per minute	3000
Working pressure	6,2 bars
Mean air consumption	140 l/min
Ø internal hose size	8 mm

2,63 kg 1 019440001

1944AR

set of 19 needles for needle scaler
item 1944



1944AR 1 019440005

1946

air riveter

• Supplied with interchangeable nozzles,
2.4-3.2-4.0-4.8 mm long

CE



Traction power	8000 N
Stroke length	14 mm
Working pressure	6,2 bars
Mean air consumption	1,2 l/cycles
Ø internal hose size	6 mm
Maximum rivet capacity	Ø aluminium 4,8 mm

1,51 kg 1 019460001

1946A

air riveter with vacuum

• Supplied with interchangeable nozzles,
2.4-3.2-4.0-4.8 mm long

CE



Traction power	8300 N
Stroke length	14 mm
Working pressure	6,2 Bar
Mean air consumption	1,3 l/cycles
Ø internal hose size	8 mm
Maximum rivet capacity	Ø aluminium 4,8 mm

1,83 kg 1 019460005

1946B

air riveter

- Supplied assembled for 4.8 – 5.6 – 6.4 mm long rivets and with interchangeable details for 2.4 – 3.2 – 4.0 mm long rivets



Traction power	12000 N
Stroke length	16 mm
Working pressure	6,2 Bar
Mean air consumption	1,6 l/cycles
Ø internal hose size	10 mm
Maximum rivet capacity	Ø steel 6,4 mm

kg	2,05	1	019460007
----	------	---	-----------

1948

engraving pen



Working pressure	6,2 bars
Mean air consumption	50 l/min

g	150	1	019480001
---	-----	---	-----------

1948PR

spare carbide bit for item 1948



1948PR	1	019480005
--------	---	-----------

1949F

progressive blow gun

- Special valve and sensitive lever allow progressive opening of circuit, resulting in optimized air flow
- 1/4" GAS female threaded insert
- Maximum operating pressure: 10 bars
- Operating temperature: -15°C +70°C.



g	133	5	019490027
---	-----	---	-----------

1949G

progressive blow gun with air regulator

- Special valve and sensitive lever allow progressive opening of circuit, resulting in optimized air flow
- 1/4" GAS female threaded insert
- Maximum operating pressure: 10 bars
- Operating temperature: -15°C +70°C.



g	145	5	019490035
---	-----	---	-----------

1949GP

tyre inflator ABS housing



1949GP	1	019490010
--------	---	-----------

1949R/NIP

1/4" GAS threaded coupling for item 1949GP



1949R/NIP	1	019490113
-----------	---	-----------

Beta



Beta



1901

automatic hose reel shock-proof plastic body for compressed air or cold water

• Max. pressure: 12 bars

CE

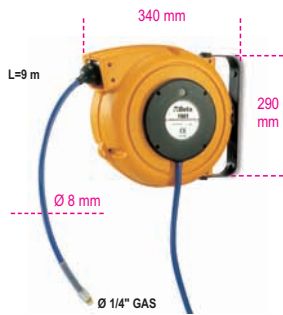

1 019010001

1901/10

automatic hose reel, shock-proof plastic body, for compressed air or cold water

• Max. working pressure: 12 bars

CE



1 019010010

1910

automatic hose reel aluminium body, for compressed air or cold water

• Max. pressure: 12 bars

CE



1 019100001

1915B

polyurethane recoil hoses, 95 Shore, extendable up to 9 m

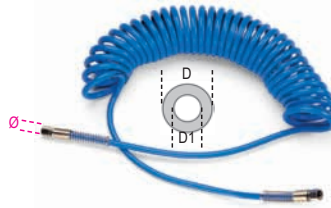

D1xD mm	Ø GAS BSP	1	019150011
6,5x10	1/4"	1	019150011
8x12	1/4"	1	019150012
11x16	3/8"	1	019150013

1915C

polyurethane recoil hoses, 95 Shore, extendable up to 12 m

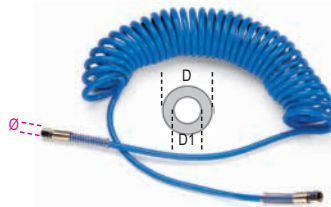

D1xD mm	Ø GAS BSP	1	019150014
6,5x10	1/4"	1	019150014
8x12	1/4"	1	019150015
11x16	3/8"	1	019150016

1915D

braided polyurethane hose, 95 Shore, 9 metres long



D1xD mm	Ø GAS BSP	1	019150017
8x12	1/4"	1	019150017
11x16	3/8"	1	019150018

1915E

braided polyurethane hose, 95 Shore, 12 metres long



D1xD mm	Ø GAS BSP	1	019150019
8x12	1/4"	1	019150019
11x16	3/8"	1	019150020

1916I

quick couplings Italian profile, made from nickel-plated brass, male threaded (BSP)



Ø GAS BSP	5	019160001
1/4"	5	019160001
3/8"	5	019160002

1916G

quick couplings European profile, zinc-plated carbonitrided steel, male threaded, tapered (BSPT)



Ø GAS BSPT	5	019160005
1/4"	5	019160005
3/8"	5	019160010
1/2"	5	019160012

1917M

universal ball quick couplers, shockproof rubber made from nickel-plated brass, male threaded (BSP)



Ø GAS BSP	5	019170001
1/4"	5	019170001
3/8"	5	019170003
1/2"	5	019170004

Beta

1917F

universal ball quick couplers,
shockproof rubber
made from nickel-plated brass,
female threaded (BSP)



Ø GAS BSP	
1/4"	5 019170005
3/8"	5 019170010

1918

safety goggles, provided
with a polycarbonate lens
and a PVC frame

CE



EN 166

1918	5 019180001
------	-------------

1918C

ear protectors made from PVC

• Attenuates 15.4 dB at 63 Hz to 37 dB
at 8000 Hz.

CE



EN 352-1

1918C	2 019180002
-------	-------------

1918M

filtering mask

CE



EN 149FFP1

1918M	20 019180003
-------	--------------

1919FE1/4

filter-regulator-lubricator



Pressure gauge inlet	1/4" GAS BSPT
Pressure gauge inlet	1/8" GAS BSPT
Maximum air capacity	750 l/min
Maximum pressure	9,5 bars
Working pressure	0,5 - 8,5 Bar
Working temperature	5 - 60 °C
Filter capacity	5 micron
Cup capacity	15 cc air / 25 cc oil

kg	1 019190200
----	-------------

1919RB-FE1/4

set of spare cups for item 1919FE1/4



1919RB-FE1/4	1 019190210
--------------	-------------

1919RF-FE1/4

spare filter for item 1919FE1/4



1919RF-FE1/4	1 019190230
--------------	-------------

1919RM-FE1/4

spare pressure gauge
for item 1919FE1/4



1919RM-FE1/4	1 019190220
--------------	-------------

1919F1/4

filter-regulator-lubricator



Air in/outlet	1/4" GAS BSPT
Maximum air capacity	1000 l/min
Maximum pressure	9,5 bars
Working pressure	0,5 - 8,5 bars
Working temperature	5 - 60 °C
Filter capacity	5 micron
Cup capacity	60 cc air / 90 cc oil

kg	1 019190250
----	-------------

Beta

1919F3/8

filter-regulator-lubricator



Air in/outlet 3/8" GAS BSPT
Maximum air capacity 1350 l/min
Maximum pressure 9,5 bars
Working pressure 0,5 - 8,5 bars
Working temperature 5 - 60 °C
Filter capacity 5 micron
Cup capacity 60 cc air / 90 cc oil

kg 1,3

1919F1/2

filter-regulator-lubricator



Air in/outlet 1/2" GAS BSPT
Maximum air capacity 2500 l/min
Maximum pressure 9,5 bars
Working pressure 0,5 - 8,5 bars
Working temperature 5 - 60 °C
Filter capacity 5 micron
Cup capacity 60 cc air / 90 cc oil

kg 1,3

1919RB-F

set of spare cups for filters
item 1919F - 1/4", 3/8" and 1/2"



cc 500

1919RF-F

spare filter for filters
item 1919F - 1/4", 3/8" and 1/2"



kg 1,3

1919RM-F

spare pressure gauge for filters
item 1919F - 1/4", 3/8" and 1/2"



kg 1,3

1919ML

mini lubricators



Ø 1/4" 1 019190030
 3/8" 1 019190032

1919SC

mini water separator



Ø 1/4" 1 019190035

1919L

ISO 32 lubricating oil

Density 20°C 875 Kg/m³
Viscosity 40°C 32 cSt
Flammability COC 210°C
Freezing -33°C



cc 500 5 019190050



CONTAINERS AND ASSORTMENTS



Aluminium^{AL}
Innovation
Technology

 **Beta**
www.beta-tools.com

2005PA/D

tool pouch,
empty, made from nylon, with belt



2005PA/D 1 020050000

2005PA/S

tool pouch,
empty, made from nylon, with belt



2005PA/S 1 020050020

2009N/BV

leather bag for maintenance,
empty



530x190x210 1 020090200

2009ID

bag with assortment of tools
for plumbing maintenance



2009ID (2009N/BV+5980ID) 1 020090011

2011/BV

bag for electricians,
empty, made from synthetic material,
with ABS sides and removable tool panel



570x260x370 1 020110200

2011ET

bags with assortments of tools
for electrotechnical maintenance



2011ET/1 (2011/BV+5980ET/1) 1 020110017
2011ET/2 (2011/BV+5980ET/2) 1 020110018

2014N/VV

synthetic tool bag with three compartments,
nylon insets and removable tool panels, empty



440x370x170 1 020140200

2014N/VU2

bag with assortment of 49 tools
for universal use



2014N/VU2 (2014N/VV+5915VU/2) 1 020140019

2029/VV

tool case,
made of thick polypropylene,
aluminium edged,
double wall construction



490x230x380 1 020290000

 **Beta**



2029E

tool cases with assortments of tools for electronic and electrotechnical maintenance



2029MQ (2029/VV+5980MQ)	1 020290050
2029ET/2 (2029/VV+5980ET/2)	1 020290010
2029EL/2 (2029/VV+5980EL/2)	1 020290015

2029/RT

universal shoulder strap for bags and cases



2029/RT	1 020290900
----------------	-------------

2032/VV

wall tool case, empty, made from plastic, provided with aluminium profile



450x390x170	1 020320010
--------------------	-------------

2032E

tool cases with assortments of tools for electronic and electrotechnical maintenance



2032ET/1 (2032/VV+5980ET/1)	1 020320007
2032EL/1 (2032/VV+5980EL/1)	1 020320006

2033N/VV

wall tool case, empty, made from aluminium, with ABS sides



500x380x200	1 020330200
--------------------	-------------

2033E

tool cases with assortments of tools for electronic and electrotechnical maintenance



2033ET/2 (2033/VV+5980ET/2)	1 020330006
2033EL/2 (2033/VV+5980EL/2)	1 020330004

2034/VV

wall tool case, empty, made from aluminium



470x380x170	1 020340200
--------------------	-------------

2034

cases with assortments of tools for electrotechnical maintenance and universal use



2034ET/1 (2034/VV+5980ET/1)	1 020340004
2034EL/1 (2034/VV+5980EL/1)	1 020340005
2034VU/2 (2034/VV+5915V/U2)	1 020340006

2036/TV

tool trolley, empty, made of thick polypropylene, aluminium edged, double wall construction, telescopic handle and castors with ball bearings



490x260x380	1 020360000
--------------------	-------------

2036E

trolley with assortments of tools for electronic and electrotechnical maintenance



  1 020360012

2036ET/2
(2036/TV+5980ET/2)

2036EL/2
(2036/TV+5980EL/2)

2051

assortment of 55 tools for nautical maintenance with shockproof polypropylene case



  1 020510100

2051

42 7 - 8 - 10 - 12 - 13 - 14 - 17 - 19 mm

55AS 3/8x7/16 - 1/2x9/16 - 5/8x11/16"

96/SP9 \varnothing 1,5÷10 mm

110 200 mm

920A \varnothing 10 - 12 - 13 - 14 - 17 - 19 mm

920AS \varnothing 7/16 - 1/2 - 9/16 - 11/16 - 7/8"

920/22 255 mm - \square 1/2 - \blacksquare 1/2

920/25 \square 1/2 - \blacksquare 1/2

920/42 \blacksquare 1/2

920/55 \blacksquare 1/2

956C \square 1/2 - 16 - 20,8 mm

1048 240 mm

1084BM 160 mm

1128BMX 145 mm

1150BM 180 mm

1166BM 160 mm

1201 \bullet 3x75 - 4x100 - 5,5x150 - 6,5x150 mm

1202 \bullet PH1x80 - PH2x100 mm

1390 \varnothing 35 mm

1490/2 \varnothing max 240 mm

1737 145 mm

1778X

1995 WD40 400 ml

1995 NS-N 25m

 580x410x90 mm - \blacksquare 9 kg

2055M

"Home Bag" case with assortment of 27 tools



  1 020550011

2055M

55 6x7-8x9-10x11-12x13 mm

96N/SP9 \varnothing 1,5-2-2,5-3-4-5-6-8-10 mm

417 4-5-6-8-9-10 mm

1151S 180 mm

1201 \bullet 3x75-4x100-5,5x150 mm

1202 \bullet PH1x80-PH2x100 mm

1370 300 g



1692B/3 3 m

 350x240x86 mm - \blacksquare 2,5 kg

2060/VV

watertight/waterproof/floating hard cavity wall tool case, made from thick resin, with manual pressure release valve, empty



  1 020600101

mm

490x410x210

2080/VV

portable organizer / tool case, empty



  1 020800101

mm

400x340x70

 **Beta**



C9 - 2109

fabric tool bag

- Hard base
- Functional interior and exterior tool pockets
- Exterior pocket with zip closure for enhanced safety
- Pocket with strap closure for personal belongings
- Double bottom
- Double string for levels
- Shoulder strap for easier transport



C9	1	021090000
2109VU/1 (C9+5915VU/1)	1	021090011
2109VU/3 (C9+5915VU/3)	1	021090113

≡ 550x280x320 mm

C10 - 2110

tool box,
made of fabric, with tool tray



C10	1	021100000
2110VU/1 (C10+5915VU/1)	1	021100011
2110VU/3 (C10+5915VU/3)	1	021100013
2110VU/AS (C10+5915VU/AS)	1	021100015

≡ 520x220x250 mm

C13

tool trunk with castors,
made of sturdy polypropylene



C13	1	021130000
-----	---	-----------

≡ 870x410x350 mm - 7,2 kg

C15 - 2115

tool box,
made from plastic, removable tote-tray



C15	1	021150001
2115VU/1 (C15+5915VU/1)	1	021150011
2115VU/3 (C15+5915VU/3)	1	021150013

≡ 480x260x260 mm

C15L - 2115L

tool box,
long series, made from plastic,
removable tote-tray



C15L	1	021150002
2115LVU/1 (C15L+5915VU/1)	1	021150111
2115LVU/3 (C15L+5915VU/3)	1	021150113

≡ 560x270x270 mm

CP16 - 2116

tool box,
made of plastic, removable tote-tray

- 2 aluminium hinges.
- folding aluminium handle.
- plastic bumper.



CP16	1	021160500
2116PVU/1 (CP16+5915VU/1)	1	021160021
2116PVU/3 (CP16+5915VU/3)	1	021160023
2116PVU/AS (CP16+5915VU/AS)	1	021160025
2116PVU/4 (CP16+5915VU/4)	1	021160024
2116PVU/2 (CP16+5915VU/2)	1	021160022

≡ 500x260x260 mm

CP17 - CP17L - 2117

tool box,
made of stainless steel and plastic,
removable tote-tray



CP17
≡ 500x200x220 mm



CP17L
≡ 575x245x265 mm

CP17	1	021170500
2117PVU/1 (CP17+5915VU/1)	1	021170031
2117PVU/3 (CP17+5915VU/3)	1	021170033
CP17L	1	021170502
2117PLVU/1 (CP17L+5915VU/1)	1	021170131
2117PLVU/3 (CP17L+5915VU/3)	1	021170133

C18 - 2118

tool box
made from sheet metal



C18	1	021180001
2118VU/1 (C18+5915VU/1)	1	021180021

≡ 450x200x100 mm

C19 - 2119 - C19L - 2119L

three-section cantilever tool box,
made from sheet metal



C19

≡ 450x200x160 mm



C19L

≡ 550x200x160 mm

C19	1	021190001
2119VU/3 (C19+5915VU/3)	1	021190013
C19L	1	021190002
2119LVU/3 (C19L+5915VU/3)	1	021190113

C20 - C20L - 2120

five-section cantilever tool box,
made from sheet metal



C20

≡ 450x200x210 mm



C20L

≡ 550x200x210 mm

C20	1	021200001
2120VU/2 (C20+5915VU/2)	1	021200012
2120VU/3 (C20+5915VU/3)	1	021200013
2120VU/AS (C20+5915VU/AS)	1	021200015
2120VU/4 (C20+5915VU/4)	1	021200014
C20L	1	021200002
2120LVU/2 (C20L+5915VU/2)	1	021200112
2120LVU/3 (C20L+5915VU/3)	1	021200113
2120LVU/AS (C20L+5915VU/AS)	1	021200115
2120LVU/4 (C20L+5915VU/4)	1	021200114

C22B O - C22BL O

tool trunk,
made of sheet metal



C22B O

≡ 720x320x310 mm



C22BL O

≡ 1010x410x400 mm

C22B O	1	022000150
C22BL O	1	022000170

C22B O: 13 kg
C22BL O: 26 kg

C22W O - C22WL O

tool trunk,
made from sheet metal,
lined for enhanced tool protection



C22W O

≡ 690x300x360 mm



C22WL O

≡ 990x300x360 mm

C22W O	1	022000269
C22WL O	1	022000299

C22W O: 15 kg
C22WL O: 28 kg

 **Beta**



C22S - 2200S

portable tool chest
with three drawers

Main features:

- Three drawers (588x277 mm) with ball bearing slides:
- 1 drawer, 50 mm high
- 2 drawers, 70 mm high.
- Front centralized safety lock.
- Retractable side handles for ease of handling.



C22S O

Model	Qty	Part No.	Price
C22S O	1	022000501	
2200S-O/VI (C22S-O+5902VI)	1	022000521	227
2200S-O/MT (C22S-O+5902MT)	1	022000531	245
2200S-O/MTAS (C22S-O+5902MT/AS)	1	022000541	246
C22S G	1	022000502	
2200S-G/VI (C22S-G+5902VI)	1	022000522	227
2200S-G/MT (C22S-G+5902MT)	1	022000532	245
2200S-G/MTAS (C22S-G+5902MT/AS)	1	022000542	246
C22S R	1	022000503	
2200S-R/VI (C22S-R+5902VI)	1	022000523	227
2200S-R/MT (C22S-R+5902MT)	1	022000533	245
2200S-R/MTAS (C22S-R+5902MT/AS)	1	022000543	246



C22S G



C22S R

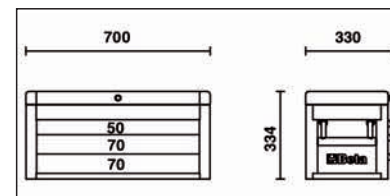
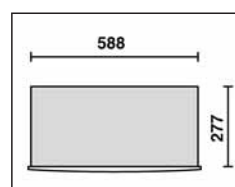

C23S - 2300S

portable tool chest
with five drawers

Main features:

- Five drawers (588x277 mm) with ball bearing slides:
- 2 drawers, 50 mm high
- 3 drawers, 70 mm high.
- Front centralized safety lock.
- Retractable side handles for ease of handling.



C23S O

Model	Qty	Part No.	Price
C23S O	1	023000501	
2300S-O/VI (C23S-O+5902VI)	1	023000551	227
2300S-O/MT (C23S-O+5902MT)	1	023000561	245
2300S-OMT/AS (C23S-O+5902MT/AS)	1	023000571	246
C23S G	1	023000502	
2300S-G/VI (C23S-G+5902VI)	1	023000552	227
2300S-G/MT (C23S-G+5902MT)	1	023000562	245
2300S-G/MTAS (C23S-G+5902MT/AS)	1	023000572	246
C23S R	1	023000503	
2300S-R/VI (C23S-R+5902VI)	1	023000553	227
2300S-R/MT (C23S-R+5902MT)	1	023000563	245
2300S-R/MTAS (C23S-R+5902MT/AS)	1	023000573	246



C23S G



C23S R

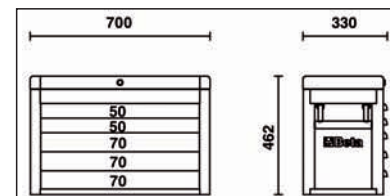
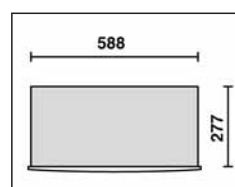

C23SC - 2300SC

portable tool chest
with eight drawers

Main features:

- Eight drawers with ball bearing slides:
4 drawers, 50 mm high
3 drawers, 70 mm high
1 drawer, 100 mm high.
- Front centralized safety lock.
- Retractable side handles for ease of transport.



C23SC O



C23SC G



C23SC R

C23SC O		1	023000511	
2300SC-O/VI	(C23SC O+5902VI)	1	023000581	227
2300SC-O/MT	(C23SC O+5902MT)	1	023000591	245
C23SC G		1	023000512	
2300SC-G/VI	(C23SC G+5902VI)	1	023000582	227
2300SC-G/MT	(C23SC G+5902MT)	1	023000592	245
C23SC R		1	023000513	
2300SC-R/VI	(C23SC R+5902VI)	1	023000583	227
2300SC-R/MT	(C23SC R+5902MT)	1	023000593	245

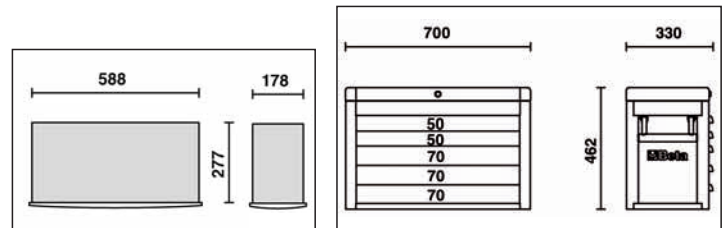

C23ST - 2300ST

portable tool chest
with five drawers

Main features:

- Five drawers (588x367 mm) with ball bearing slides:
5 drawers, 70 mm high.
- Front centralized safety lock.
- Load capacity of one drawer: 15 kg
- Can be fitted with kit composed of 4 castors and 1 handle (2300ST/KIT)



C23ST O



C23ST G



C23ST R

C23ST O		1	023000521	
2300ST-O/VI1T	(C23ST O+5904VI/1T)	1	023000621	228
2300ST-O/VG1T	(C23ST O+5904VG/1T)	1	023000631	247
C23ST G		1	023000522	
2300ST-G/VI1T	(C23ST G+5904VI/1T)	1	023000622	228
2300ST-G/VG1T	(C23ST G+5904VG/1T)	1	023000632	247
C23ST R		1	023000523	
2300ST-R/VI1T	(C23ST R+5904VI/1T)	1	023000623	228
2300ST-R/VG1T	(C23ST R+5904VG/1T)	1	023000633	247

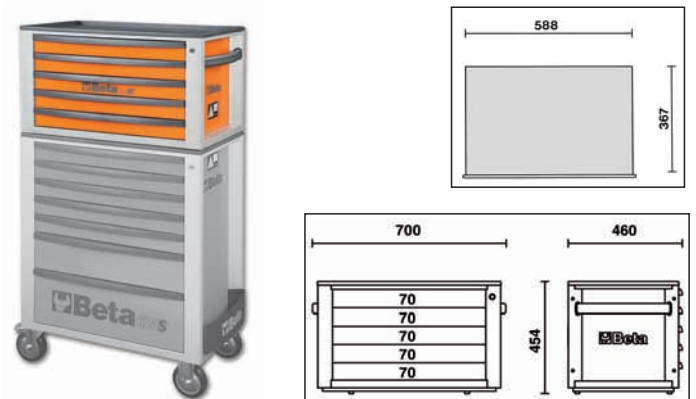

2300ST/KIT

kit with 4 castors and 1 handle for item C23ST

- Four castors 125 mm in Ø:
2 fixed and 2 steering (two with brakes).
- Telescopic handle



2300ST/KIT

1 023000950

CD23S

Caddy trolley

Main features:

- ABS worktop designed to match tool chests C22S, C23S, C23SC.
- The removable handle can be stored underneath the chassis.
- Four castors 125 mm in Ø:
2 fixed and 2 steering (one with brake).
- Maximum load: 250 kg.



CD23S

1 023000610

 **Beta**



C24S/5 - 2400S5

mobile roller cab with five drawers

Main features:

- Five drawers (588x367 mm) with ball bearing slides:
 - 2 drawers, 70 mm high
 - 2 drawers, 140 mm high
 - 1 drawer, 290 mm high
- Drawer bases protected by foamed rubber mats.
- Four castors 125 mm in Ø:
 - 2 fixed and 2 steering (one with brake).
- Front centralized safety lock.
- Static load capacity: 800 kg.
- Thermoplastic worktop designed to match tool chests C22S, C23S, C23SC and C23ST
- Integrated side bottle holder.
- Paper roll holder item 2400S-R/PC can also be included.



C24S O/5



C24S G/5



C24S R/5

C24S O/5		1	024002051	
2400S5-O/VI1T	(C24S5/O+5904VI/1T)	1	024002501	228
2400S5-O/VG2T	(C24S5/O+5904VG/2T)	1	024002511	248
2400S5-O/VG3	(C24S5/O+5904VG/3)	1	024002521	249
C24S G/5		1	024002052	
2400S5-G/VI1T	(C24S5/G+5904VI/1T)	1	024002502	228
2400S5-G/VG2T	(C24S5/G+5904VG/2T)	1	024002512	248
2400S5-G/VG3	(C24S5/G+5904VG/3)	1	024002522	249
C24S R/5		1	024002053	
2400S5-R/VI1T	(C24S5/R+5904VI/1T)	1	024002503	228
2400S5-R/VG2T	(C24S5/R+5904VG/2T)	1	024002513	248
2400S5-R/VG3	(C24S5/R+5904VG/3)	1	024002523	249

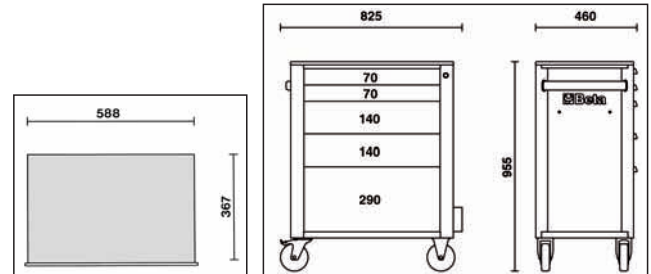

 **Beta**



C24S/6 - 2400S6

mobile roller cab with six drawers

Main features:

- Six drawers (588x367 mm) with ball bearing slides:
 - 4 drawers, 70 mm high
 - 1 drawer, 140 mm high
 - 1 drawer, 290 mm high
- Drawer bases protected by foamed rubber mats.
- Four castors 125 mm in Ø:
 - 2 fixed and 2 steering (one with brake).
- Front centralized safety lock.
- Static load capacity: 800 kg.
- Thermoplastic worktop designed to match tool chests C22S, C23S, C23SC and C23ST.
- Integrated side bottle holder.
- Paper roll holder item 2400S-R/PC can also be included.



C24S O/6



C24S G/6



C24S R/6

C24S O/6		1	024002061	
2400S6-O/VI1T	(C24S6/O+5904VI/1T)	1	024002611	228
2400S6-O/VG2T	(C24S6/O+5904VG/2T)	1	024002621	248
2400S6-O/VG3	(C24S6/O+5904VG/3)	1	024002631	249
C24S G/6		1	024002062	
2400S6-G/VI1T	(C24S6/G+5904VI/1T)	1	024002612	228
2400S6-G/VG2T	(C24S6/G+5904VG/2T)	1	024002622	248
2400S6-G/VG3	(C24S6/G+5904VG/3)	1	024002632	249
C24S R/6		1	024002063	
2400S6-R/VI1T	(C24S6/R+5904VI/1T)		024002613	228
2400S6-R/VG2T	(C24S6/R+5904VG/2T)	1	024002623	248
2400S6-R/VG3	(C24S6/R+5904VG/3)	1	024002633	249

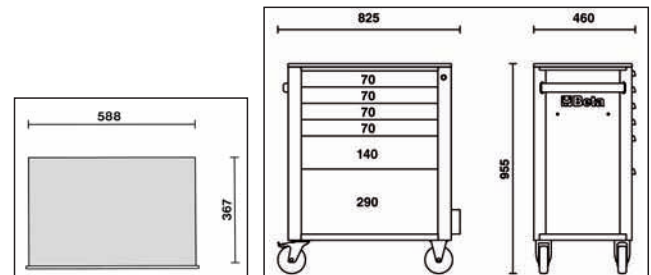

 **Beta**



C24S/7 - 2400S7

mobile roller cab with seven drawers

Main features:

- Seven drawers (588x367 mm) with ball bearing slides:
- 5 drawers, 70 mm high
- 1 drawer, 140 mm high
- 1 drawer, 210 mm high
- Drawer bases protected by foamed rubber mats.
- Four castors 125 mm in Ø:
- 2 fixed and 2 steering (one with brake).
- Front centralized safety lock.
- Static load capacity: 800 kg.
- Thermoplastic worktop designed to match tool chests C22S, C23S, C23SC and C23ST
- Integrated side bottle holder.
- Paper roll holder item 2400S-R/PC can also be included.



C24S O/7

Model	Accessories	Quantity	Part Number	Price
C24S O/7		1	024002071	
2400S7-O/VI2T	(C24S7/O+5904VI/2T)	1	024002701	229
2400S7-O/VI3	(C24S7/O+5904VI/3)	1	024002711	230
2400S7-O/VG1T	(C24S7/O+5904VG/1T)	1	024002721	247
2400S7-O/VG3	(C24S7/O+5904VG/3)	1	024002731	249
C24S G/7		1	024002072	
2400S7-G/VI2T	(C24S7/G+5904VI/2T)	1	024002702	229
2400S7-G/VI3	(C24S7/G+5904VI/3)	1	024002712	230
2400S7-G/VG1T	(C24S7/G+5904VG/1T)	1	024002722	247
2400S7-G/VG3	(C24S7/G+5904VG/3)	1	024002732	249
C24S R/7		1	024002073	
2400S7-R/VI2T	(C24S7/R+5904VI/2T)	1	024002703	229
2400S7-R/VI3	(C24S7/R+5904VI/3)	1	024002713	230
2400S7-R/VG1T	(C24S7/R+5904VG/1T)	1	024002723	247
2400S7-R/VG3	(C24S7/R+5904VG/3)	1	024002733	249



C24S G/7



C24S R/7

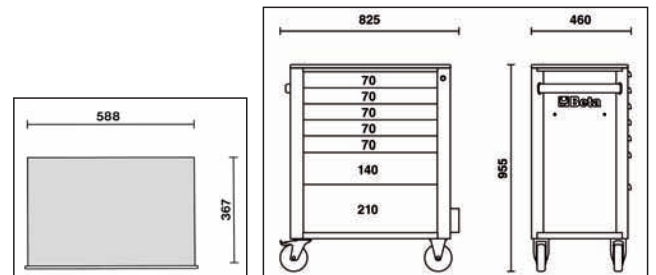

Beta



C24S/8 - 2400S8

mobile roller cab with eight drawers

Main features:

- Eight drawers (588x367 mm) with ball bearing slides:
 - 6 drawers, 70 mm high
 - 2 drawers, 140 mm high
- Drawer bases protected by foamed rubber mats.
- Four castors 125 mm in Ø:
 - 2 fixed and 2 steering (one with brake).
- Front centralized safety lock.
- Static load capacity: 800 kg.
- Thermoplastic worktop designed to match tool chests C22S, C23S, C23SC and C23ST.
- Integrated side bottle holder.
- Paper roll holder item 2400S-R/PC can also be included.



C24S O/8		1	024002081	
2400S8-O/VI2T	(C24S8/O+5904VI/2T)	1	024002801	229
2400S8-O/VG3	(C24S8/O+5904VG/3)	1	024002811	249
2400S8-O/VG5T	(C24S8/O+5904VG/5T)	1	024002821	251
C24S G/8		1	024002082	
2400S8-G/VI2T	(C24S8/G+5904VI/2T)	1	024002802	229
2400S8-G/VG3	(C24S8/G+5904VG/3)	1	024002812	249
2400S8-G/VG5T	(C24S8/G+5904VG/5T)	1	024002822	251
C24S R/8		1	024002083	
2400S8-R/VI2T	(C24S8/R+5904VI/2T)	1	024002803	229
2400S8-R/VG3	(C24S8/R+5904VG/3)	1	024002813	249
2400S8-R/VG5T	(C24S8/R+5904VG/5T)	1	024002823	251

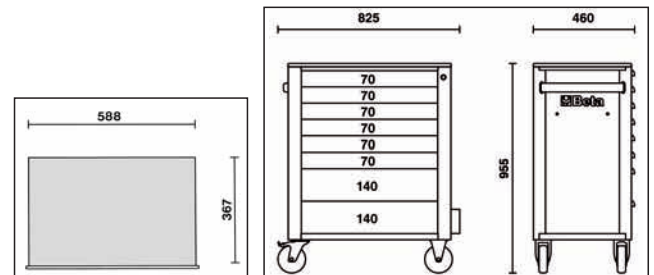

2400S-R/PC

paper roll holder

- Matches roller cabs C24S

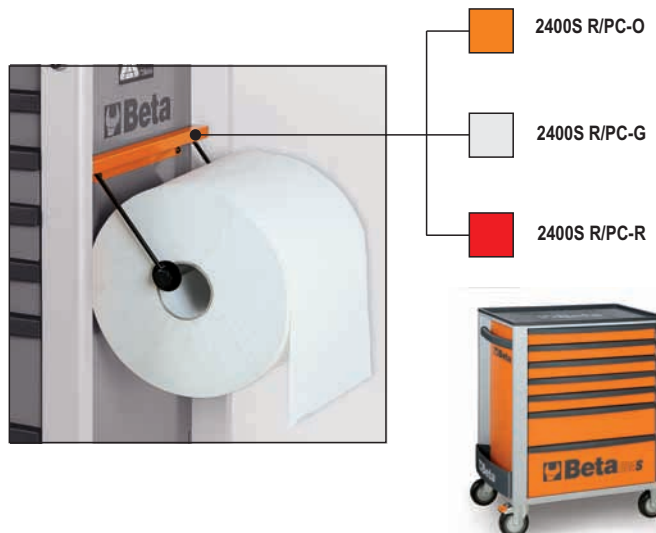

2400S R/PC-O		1	024002951
2400S R/PC-G		1	024002952
2400S R/PC-R		1	024002953

2499PF

bottle holder

• Can match roller cabs C38, C38A and trolley CX52.

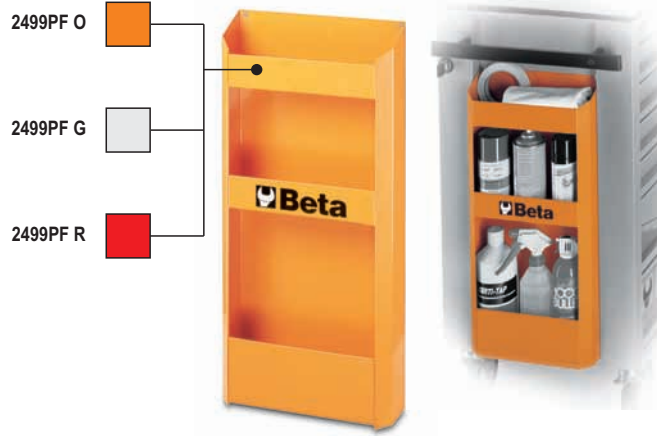

2499PF O	1	024990210
2499PF G	1	024990219
2499PF R	1	024990230

2499PF/M

universal magnetic bottle holder



2499PF/M	1	024990050
----------	---	-----------

2499PP/M

magnetic support for impact wrenches



2499PP/M	1	024990060
----------	---	-----------

2499PC

paper roll holder

• Matches all Tank, NewTeam trolleys and roller cabs and C38, C38A.



2499PC	1	024990090
--------	---	-----------

C24SL - 2400SL

mobile roller cab
with seven drawers
and side tops

Main features:

- Seven drawers (588x367 mm) with ball bearing slides:
 - 5 drawers, 70 mm high
 - 1 drawer, 140 mm high
 - 1 drawer, 210 mm high.
- Drawer bases protected by foamed rubber mats.
- Four castors 125 mm in Ø:
 - 2 fixed and 2 steering (two with brakes).
- Front centralized safety lock.
- Static load capacity: 800 kg.
- Multi-ply wood worktop with holes for a vice (1599 M100, to be ordered separately).
- Side compartment with vertically adjustable top.
- Integrated paper roll holder.
- Double rear bottle holder.

800
kg



C24SL O



C24SL G



C24SL R

Model	Accessories	Qty	Code	Price
C24SL O		1	024002101	
2400SL-O/VI3	(C24SL/O+5904VI/3)	1	024002401	230
2400SL-O/VG3	(C24SL/O+5904VG/3)	1	024002411	249
2400SL-O/VG4T	(C24SL/O+5904VG/4T)	1	024002421	250
C24SL G		1	024002102	
2400SL-G/VI3	(C24SL/G+5904VI/3)	1	024002402	230
2400SL-G/VG3	(C24SL/G+5904VG/3)	1	024002412	249
2400SL-G/VG4T	(C24SL/G+5904VG/4T)	1	024002422	250
C24SL R		1	024002103	
2400SL-R/VI3	(C24SL/R+5904VI/3)	1	024002403	230
2400SL-R/VG3	(C24SL/R+5904VG/3)	1	024002413	249
2400SL-R/VG4T	(C24SL/R+5904VG/4T)	1	024002423	250

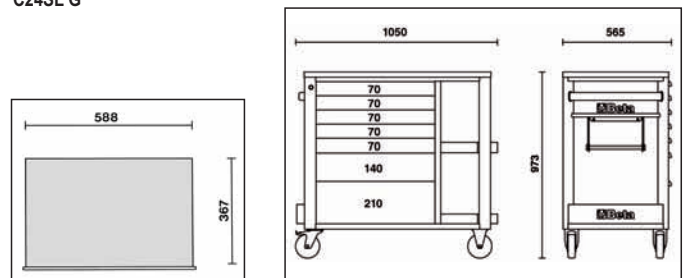

C25 - 2500

Tank trolley with shelf

Main features:

- Foldaway lid.
- 1 sliding drawer.
- Tool tray protected by foamed rubber mats.
- Shelves protected by oil and fuel proof mats.
- Four castors 100 mm in Ø:
 - 2 fixed and 2 swivelling (one with brake).
- Safety lock.
- One more shelf M4 can be added on the opposite side.
- Empty thermoformed tray for 1/2" sockets and accessories.
- Paper roll holder item 2499PC can also be included



Model	Accessories	Qty	Code	Price
C25		1	025000001	
2500/VI1	(C25+5902VI)	1	025000069	227
2500/VG0	(C25+5905VG/0)	1	025000071	251
2500/VG1	(C25+5905VG/1)	1	025000072	252
2500/VG2	(C25+5905VG/2)	1	025000073	252

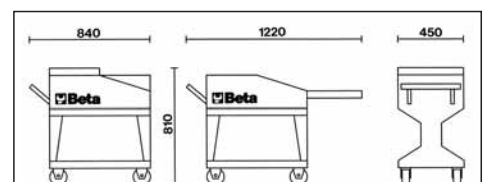

C28N - 2800N

SuperTank trolley
with eleven drawers

Main features:

- Eleven drawers (588x367 mm) with slides.
- Five side drawers:
 - 1 drawer, 50 mm high
 - 3 drawers, 80 mm high
 - 1 drawer, 160 mm high
- Six front drawers:
 - 1 drawer, 50 mm high
 - 5 drawers, 80 mm high
- Drawer bases protected by foamed rubber mats.
- Four castors made from adiprene, 150 mm in \varnothing :
 - 2 fixed and 2 swivelling (with brake).
- 2 safety locks.
- Multi-layered worktop with holes for a vice (1599 M100 to be ordered separately).
- Side compartment with foldaway door.
- 170 mm high storage compartment with base protected by oil-proof ribbed rubber.
- Integrated plastic tool-holder.
- Static load capacity: 1200 kg.



C28N O



C28N G



C28N R

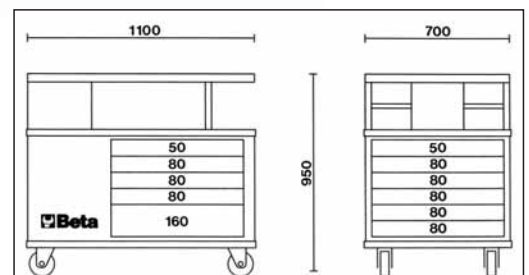
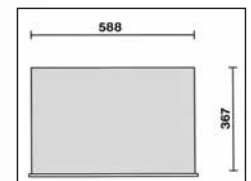

Model	Accessories	Quantity	Part Number	Price
C28N O		1	028000004	
2800N O/VI1	(C28N O+5908/VI1)	1	028000311	231
2800N O/VI2T	(C28N O+5908/VI/2T)	1	028000321	232
2800N O/VG1	(C28N O+5908/VG/1)	1	028000331	253
2800N O/VG2	(C28N O+5908/VG/2)	1	028000341	254
C28N G		1	028000006	
2800N G/VI1	(C28N G+5908/VI/1)	1	028000312	231
2800N G/VI2T	(C28N G+5908/VG/2T)	1	028000322	232
2800N G/VG1	(C28N G+5908/VG/1)	1	028000332	253
2800N G/VG2	(C28N G+5908/VG/2)	1	028000342	254
C28N R		1	028000007	
2800N R/VI1	(C28N R+5908/VI/1)	1	028000313	231
2800N R/VI2T	(C28N R+5908/VI/2T)	1	028000323	232
2800N R/VG1	(C28N R+5908/VG/1)	1	028000333	253
2800N R/VG2	(C28N R+5908/VG/2)	1	028000343	254

C30 - 3000

MaxiTank mobile workbench

Main features:

- Drawers with ball bearing slides designed to support heavy loads.
- Two rear drawers (670x500x140 mm) with locking system.
- Six front drawers:
 - 4 drawers 600x250x70 mm
 - 2 drawers 600x250x140 mm
- Double side locking system for both drawers and doors.
- One hydraulic jack designed to lift the front part easily.
- Adiprene castors on ball bearing slides:
 - 2 swivelling, 150 mm in \varnothing
 - 2 fixed, 170 mm in \varnothing .
- Drawer bases protected by foamed rubber mats.
- Multi-layered wooden worktop, 800x500 mm, with three holes for a vice (1599 M125/M150/M165 to be ordered separately).
- Oil-proof removable rubber top, 800x800 mm with drain hole connected to a small container for collecting fluids.
- Storage compartment, 720x250x1300 mm, with PVC-coated worktop and two sliding panels.



C30		1	030000001	
3000/VI1	(C30+5908VI/1)	1	030000071	231
3000/VI3	(C30+5910VI/3)	1	030000082	233
3000/VG3	(C30+5910VG/3)	1	030000084	255

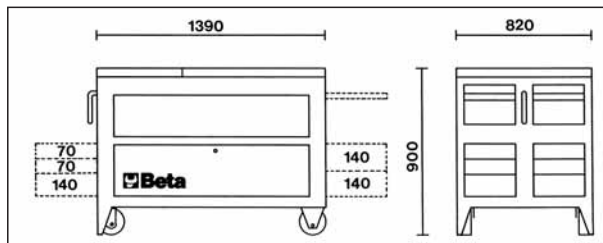

Beta



C36/5 - 3600

"EVOLUTION" roller cab
with five drawers

Main features:

- Five drawers (588x367 mm) with ball bearing slides:
3 drawers, 70 mm high
1 drawer, 210 mm high
1 drawer, 290 mm high.
- Drawer bases protected by foamed rubber mats.
- Four castors 125 mm in Ø:
2 fixed and 2 steering (1 with brake).
- Front centralized safety lock.
- Opening system throughout length of drawer.
- Static load capacity: 1000 kg.
- ABS-coated worktop.
- Integrated side bottle holders.
- Integrated side tool holder.
- Integrated paper holder.
- Plastic bumper.
- Handle covered with antislip terry cloth.



C36 O/5



C36 G/5



C36 R/5

Model	Accessories	Qty	Part No.	Price
C36/O-5		1	036000005	
3600 O-5/VI1T	(C36 O/5+5904VI/1T)	1	036000201	228
3600 O-5/VG2T	(C36 O/5+5904VG/2T)	1	036000211	248
C36/G-5		1	036000025	
3600 G-5/VI1T	(C36 G/5+5904VI/1T)	1	036000202	228
3600 G-5/VG2T	(C36 G/5+5904VG/2T)	1	036000212	248
C36/R-5		1	036000015	
3600 R-5/VI1T	(C36 R/5+5904VI/1T)	1	036000203	228
3600 R-5/VG2T	(C36 R/5+5904VG/2T)	1	036000213	248

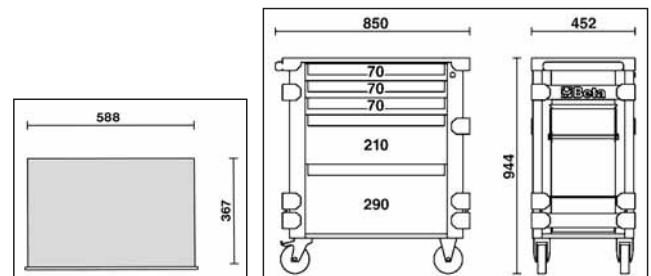

 **Beta**



C36/7 - 3600

"EVOLUTION" roller cab
with seven drawers

Main features:

- Seven drawers (588x367 mm) with ball bearing slides:
5 drawers, 70 mm high
1 drawer, 140 mm high
1 drawer, 210 mm high.
- Drawer bases protected by foamed rubber mats.
- Four castors 125 mm in Ø:
2 fixed and 2 steering (1 with brake).
- Front centralized safety lock.
- Opening system throughout length of drawer.
- Static load capacity: 1000 kg.
- ABS-coated worktop.
- Integrated side bottle holders.
- Integrated side tool holder.
- Integrated paper holder.
- Plastic bumper.
- Handle covered with antislip terry cloth.



C36 O/7



C36 G/7



C36 R/7

C36/O-7	1	036000007	
3600 O-7/VI2T (C36 O/7+5904VI/2T)	1	036000221	229
3600 O-7/VG1T (C36 O/7+5904VG/1T)	1	036000231	247
3600 O-7/VG4T (C36 O/7+5904VG/4T)	1	036000241	250
C36/G-7	1	036000027	
3600 G-7/VI2T (C36 G/7+5904VI/2T)	1	036000222	229
3600 G-7/VG1T (C36 G/7+5904VG/1T)	1	036000232	247
3600 G-7/VG4T (C36 G/7+5904VG/4T)	1	036000242	250
C36/R-7	1	036000017	
3600 R-7/VI2T (C36 R/7+5904VI/2T)	1	036000223	229
3600 R-7/VG1T (C36 R/7+5904VG/1T)	1	036000233	247
3600 R-7/VG4T (C36 R/7+5904VG/4T)	1	036000243	250

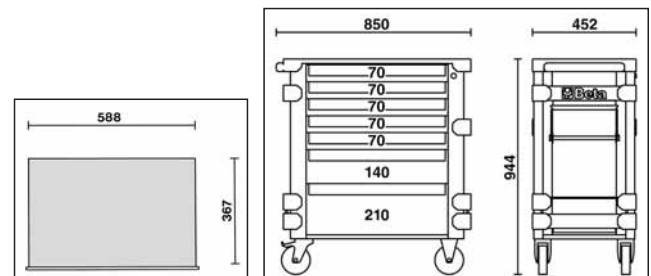

C36/PLA

antislip aluminium worktop
for roller cabs C36/5 and C36/7



C36/PLA			1	036000105
---------	--	--	---	-----------

C38 - 3800

mobile roller cab
with eleven drawers

Main features:

- Eleven drawers with ball bearing slides:
- 1 drawer 937x410x122 mm
- 3 drawers 570x410x74 mm
- 2 drawers 570x410x153 mm
- 3 drawers 313x410x74 mm
- 2 drawers 313x410x153 mm.
- Drawer bases protected by foamed rubber mats.
- Static load capacity: 1200 kg.
- 4 high-capacity castors: Ø 125 mm:
- 2 fixed and 2 steering (both with lever brake).
- Front centralized lock.
- Sheet metal worktop covered by a rubber mat.
- Can be fitted with paper roll holder item 2499PC and bottle holder item 2499PF.



C38 O



C38 G



C38 R

Model	Accessories	Qty	Part No.	Price
C38 O		1	038000001	
3800 O/U2	(C38 O+5938U/2)	1	038000051	240
C38 G		1	038000003	
3800 G/U2	(C38 G+5938U/2)	1	038000052	240
C38 R		1	038000002	
3800 R/U2	(C38 R+5938U/2)	1	038000053	240

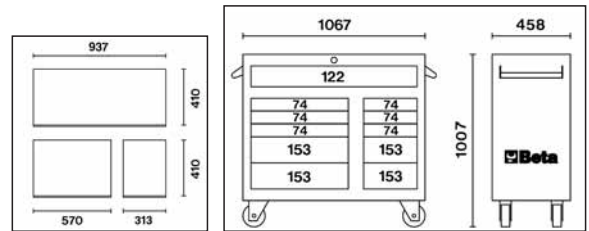

 **Beta**



C38A - 3800A

mobile roller cab
with six drawers and one compartment with doored shelf

Main features:

- Six drawers with ball bearing slides:
1 drawer 937x410x122 mm
3 drawers 570x410x74 mm
2 drawers 570x410x153 mm.
- Vertically adjustable interior shelf.
- Inside door document pocket.
- Drawer bases protected by foamed rubber mats.
- Static load capacity: 1200 kg.
- 4 high-capacity castors: Ø 125 mm:
2 fixed and 2 swivelling (both with lever brake).
- Front centralized lock.
- Sheet metal worktop covered by a rubber mat.
- Can be fitted with paper roll holder item 2499PC and bottle holder item 2499PF.

1200
kg



C38A O



C38A G



C38A R

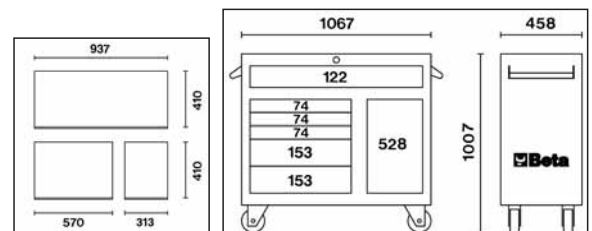

C38A O	1	038000301
C38A G	1	038000303
C38A R	1	038000302

 **Beta**



C38L

side cab
with 7 drawers

Main features:

- Seven drawers (410x313 mm) with ball bearing slides:
5 drawers, 74 mm high
2 drawers, 153 mm high
- Drawer bases protected by foamed rubber mats.
- Front centralized safety lock.
- Antislip aluminium worktop.
- Can be placed on both sides of roller cab C38 and C38A.



C38L O



C38L G



C38L R

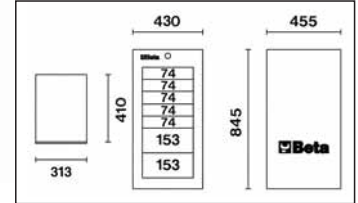

C38L O	1	038000081
C38L G	1	038000083
C38L R	1	038000082

C38L A

side door
with interior shelf

Main features:

- Front lock.
- Vertically adjustable interior shelf.
- Inside door document pocket.
- Antislip aluminium worktop.
- Can be placed on both sides of roller cab C38.



C38L A O



C38L A G



C38L A R

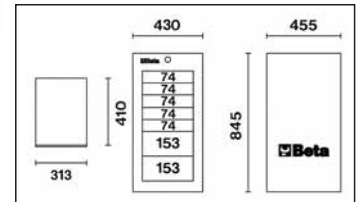

C38L A-O	1	038000071
C38L A-G	1	038000072
C38L A-R	1	038000073

C38T

cab
with eight drawers and top chest

Main features:

- Eight drawers with ball bearing slides:
3 drawers 570x410x74 mm
1 drawer 570x410x153 mm
3 drawers 313x410x74 mm
1 drawer 313x410x153 mm.
- Tool compartment.
- Drawer bases protected by foamed rubber mats.
- Front centralized safety lock.
- Antislip aluminium worktop.
- Can be placed on roller cab C38 and C38A.



C38T O

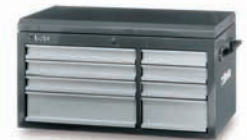

C38T G



C38T R

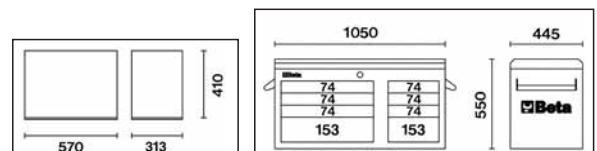

C38T O	1	038000091
C38T G	1	038000093
C38T R	1	038000092

C38C

mobile roller cab
with thirty three drawers,
comprising:

- 1 mobile roller cab C38
- 2 side cabs C38L
- 1 cab C38T with top chest



C38C O



C38C G



C38C R

C38C O	1	038000201
C38C G	1	038000203
C38C R	1	038000202

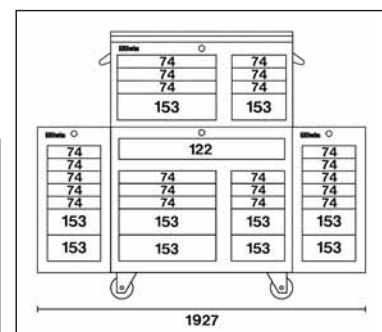
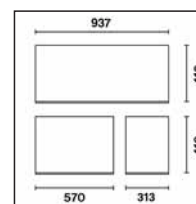

C39/6 - 3900

mobile roller cab with six drawers

Main features:

- Six drawers (588x367 mm) with ball bearing slides:
- 4 drawers, 70 mm high
- 1 drawer, 140 mm high
- 1 drawer, 280 mm high
- Drawer bases protected by foamed rubber mats.
- Four castors 125 mm in Ø:
- 2 fixed and 2 steering (one with brake).
- Front centralized safety lock.
- Opening system throughout length of drawer.
- Static load capacity: 1200 kg.
- Thermoplastic worktop.
- Integrated side and rear bottle holders.
- Integrated paper roll holder.
- Uprights and drawer front made of aluminium.



C39 O/6



C39 G/6



C39 R/6



C39 O/6	1	039000031	
3900 O-6/VI1T (C39 O/6+5904VI/1T)	1	039000111	228
3900 O-6/VG2T (C39 O/6+5904VG/2T)	1	039000121	248
C39 G/6	1	039000032	
3900 G-6/VI1T (C39 G/6+5904VI/1T)	1	039000112	228
3900 G-6/VG2T (C39 G/6+5904VG/2T)	1	039000122	248
C39 R/6	1	039000033	
3900 R-6/VI1T (C39 R/6+5904VI/1T)	1	039000113	228
3900 R-6/VG2T (C39 R/6+5904VG/2T)	1	039000123	248

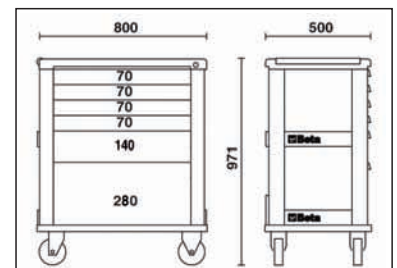
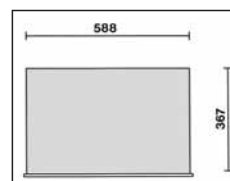

C39/7 - 3900

roller cab
with seven drawers

Main features:

- Seven drawers (588x367 mm) with ball bearing slides:
 - 5 drawers, 70 mm high
 - 1 drawer, 140 mm high
 - 1 drawer, 210 mm high.
- Drawer bases protected by foamed rubber mats.
- Four castors 125 mm in Ø:
 - 2 fixed and 2 steering (1 with brake).
- Front centralized safety lock.
- Opening system throughout length of drawer.
- Static load capacity: 1000 kg.
- Thermoplastic worktop.
- Integrated side and rear bottle holders.
- Integrated paper roll holder.
- Uprights and drawer front made of aluminium.



C39 O/7



C39 G/7



C39 R/7



Model	Accessories	Quantity	Part Number	Price
C39 O		1	039000001	
3900 O-7/VI2T	(C39 O/7+5904VI/2T)	1	039000131	229
3900 O-7/VG1T	(C39 O/7+5904VG/1T)	1	039000141	247
3900 O-7/VG4T	(C39 O/7+5904VG/4T)	1	039000161	250
C39 G		1	039000002	
3900 G-7/VI2T	(C39 G/7+5904VI/2T)	1	039000132	229
3900 G-7/VG1T	(C39 G/7+5904VG/1T)	1	039000142	247
3900 G-7/VG4T	(C39 G/7+5904VG/4T)	1	039000162	250
C39 R		1	039000003	
3900 R-7/VI2T	(C39 R/7+5904VI/2T)	1	039000133	229
3900 R-7/VG1T	(C39 R/7+5904VG/1T)	1	039000143	247
3900 R-7/VG4T	(C39 R/7+5904VG/4T)	1	039000163	250

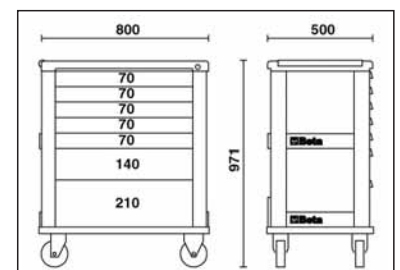
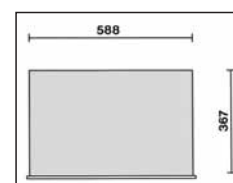

C39/8 - 3900

mobile roller cab with eight drawers

Main features:

- Eight drawers (588x367 mm) with ball bearing slides:
- 6 drawers, 70 mm high
- 2 drawers, 140 mm high
- Drawer bases protected by foamed rubber mats.
- Four castors 125 mm in Ø:
- 2 fixed and 2 steering (one with brake).
- Front centralized safety lock.
- Opening system throughout length of drawer.
- Static load capacity: 1200 kg.
- Thermoplastic worktop.
- Integrated side and rear bottle holders.
- Integrated paper roll holder.
- Uprights and drawer front made of aluminium.



C39 O/8



C39 G/8



C39 R/8



C39 O/8	1	039000041	
3900 O-8/VI2T (C39 O/8+5904VI/2T)	1	039000171	229
3900 O-8/VG5T (C39 O/8+5904VG/5T)	1	039000181	251
C39 G/8	1	039000042	
3900 G-8/VI2T (C39 G/8+5904VI/2T)	1	039000172	229
3900 G-8/VG5T (C39 G/8+5904VG/5T)	1	039000182	251
C39 R/8	1	039000043	
3900 R-8/VI2T (C39 R/8+5904VI/2T)	1	039000173	229
3900 R-8/VG5T (C39 R/8+5904VG/5T)	1	039000183	251

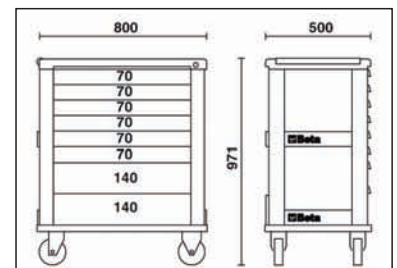
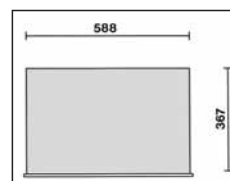

C39T - 3900T

portable tool chest
with four drawers

Main features:

- Four drawers (588x367 mm) with ball bearing slides: 4 drawers, 70 mm high
- Front centralized safety lock.
- Load capacity of one drawer: 15 kg
- Uprights and drawer front made of aluminium.



C39T O



C39T G



C39T R

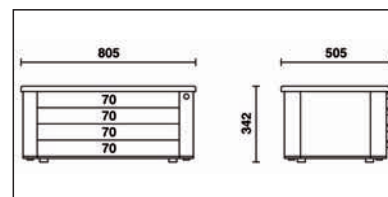
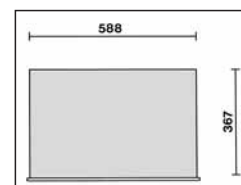

C39T O	1	039000101
C39T G	1	039000102
C39T R	1	039000103

C39/PM

small tool panel for item C39



C39/PM	1	039000530
--------	---	-----------

C39/PU

tool panel for item C39



C39/PU	1	039000529
--------	---	-----------

C41S - 4100S

two-module tool trolley

Main features:

- Sheet metal frame and plastic tops, synonymous with remarkable sturdiness and reduced weight.
- 2 detachable modules:
 - 1 upper tool box,
 - 1 module with 2 drawers, 95 mm and 295 mm high respectively.
- Oversized castors (160 mm), built into frame for easy transport - for example, on steps.
- Side centralized lock for closing drawers of lower module.
- Drawers with ball bearing slides and double closing hook.
- Telescopic aluminium handle.
- Small tool holder built into upper tool box.



			
C41S	1	041000001	
4100S/VU3 (C41S+5915VU/3)	1	041000081	238
4100S/M2 (C41S+5940/M2)	1	041000082	256

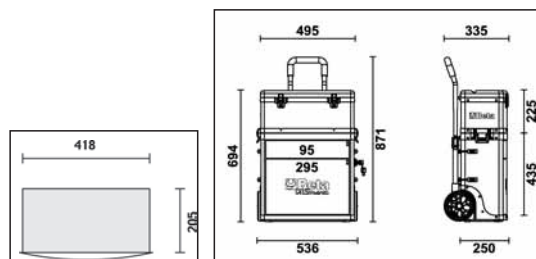



C41H - 4100H

two-module tool trolley

Main features:

- Sheet metal frame and plastic tops, synonymous with remarkable sturdiness and reduced weight.
- 2 detachable modules:
 - 1 upper tool box,
 - 1 module with 2 drawers 95 mm in height,
 - 1 pull-out case made of plastic, 66 mm high, and 1 drawer 295 mm in height.
- Oversized castors (160 mm), built into frame for easy transport - for example, on steps.
- Side centralized lock for closing drawers of lower module.
- Drawers with ball bearing slides and double closing hook.
- Telescopic aluminium handle.
- Small tool holder built into upper tool box.



			
C41H	1	041000002	
4100H/VU3 (C41H+5915VU/3)	1	041000091	238
4100H/M2 (C41H+5940/M2)	1	041000092	256

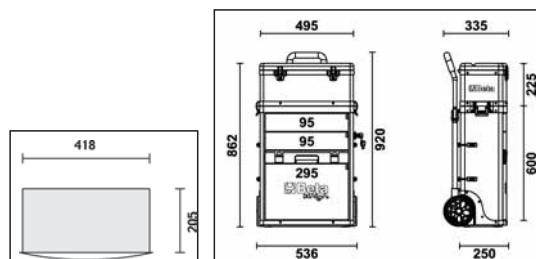

C41MS

upper module
with built-in small tool holder



C41MS

 1  041000904

C41H/CE

tool chest
with removable partitions for small tools,
made from plastic material

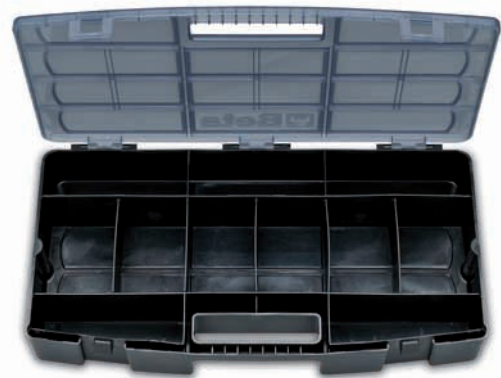

C41H/CE

 1  041000916

C51

trolley

- 3 tops covered in antislip ribbed rubber
- Ergonomic handle
- Two fixing options for central worktop
- Four castors Ø 100 mm:
2 fixed and 2 steering (1 with brake)



C51

 1  051000001

CX52

NewTeam trolley

Main features:

- Upper worktop designed to perfectly match NewCargo cabinets, by means of two screws.
- ABS upper worktop.
- Ribbed rubber tops.
- Four castors 125 mm in ø:
2 fixed and 2 swivelling (one with brake).
- Paper roll holder item 2499PC and bottle-holder item 2499PF can also be included.

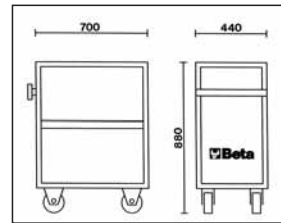
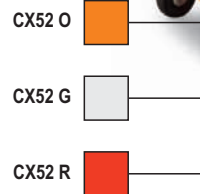

CX52 O	1	052000001
CX52 G	1	052000002
CX52 R	1	052000003

C53 - 5300

CargoEvolution tool cabinets

These tool cabinets are designed according to detailed research and offer accurate, comfortable and rational solutions for end users.

Two perforated panels attached to the doors may be opened giving access to additional storage space.

Main features:

- 1 drawer, with slides.
- Easy tool layout according to users' needs.
- Easy wall mounting by means of two slots located at the back of the cabinet or can be fitted onto the C50 Team trolley, by means of two screws.
- Safety lock for both drawers and doors.
- Empty thermoformed tray for 1/2" sockets and accessories
- Models VI and VG have different toolholder assortments.



C53



5300

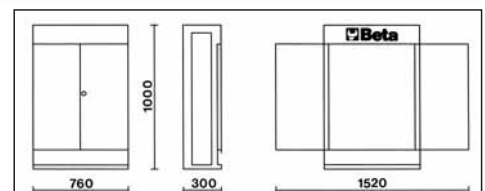

C53		1	053000001	
C53VI		1	053000090	
5300VI	(C53VI+5953VI)	1	053000011	234
C53VG		1	053000095	
5300VG	(C53VG+5953VG)	1	053000021	256

C54 - 5400

NewCargo cabinets

Same features as item C53.

- Matches trolley CX52 by means of two screws.
- Empty thermoformed tray for 1/2" sockets and accessories.
- Single-sided doors.
- Models VI and VG have different toolholder assortments.



5400 O

C54 O		1	054000001	
C54VI O		1	054000090	
5400 O/VI	(C54VI O+5954VI)	1	054000170	234
C54VG O		1	054000095	
5400 O/VG	(C54VG O+5954VG)	1	054000180	257
C54 G		1	054000002	
C54VI G		1	054000092	
5400 G/VI	(C54VI G+5954VI)	1	054000172	234
C54VG G		1	054000097	
5400 G/VG	(C54VG G+5954VG)	1	054000182	257
C54 R		1	054000003	
C54VI R		1	054000093	
5400 R/VI	(C54VI R+5954VI)	1	054000174	234
C54VG R		1	054000098	
5400 R/VG	(C54VG R+5954VG)	1	054000184	257



C54 O



C54 G



C54 R

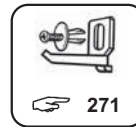

271

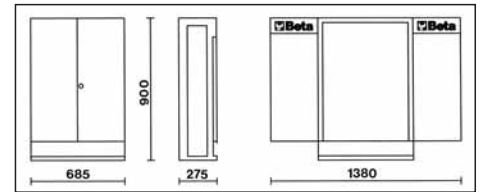

Beta



C57A - 5700A

MasterCargo workbench

- Model with tool storage board (C57P) and one drawer cabinet.
 - Drawer cabinet: five drawers with ball bearing slides to support heavy loads.
 - Centralized locking system.
- Panel toolholder with two holes on the back for wall mounting.
- Aluminium shutter with safety lock.
 - Three removable perforated panels for tool holding.
 - Worktop made from multi-layered wood with plastic laminate finishing with three holes for a vice 1599 M125/M150/M165, to be ordered separately.



C57A O



C57A G



5700A O



C57A R

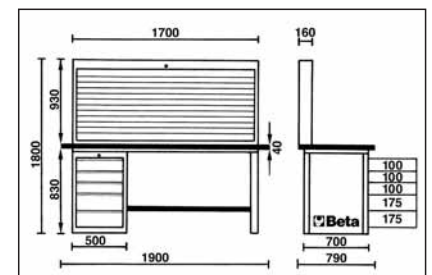

Model	Accessories	Quantity	Part Number	Price
C57A O		1	057000001	
5700A O/VI	(C57A O+5957VI)	1	057000091	235
5700A O/VG	(C57A O+5957VG)	1	057000092	258
C57A G		1	057000201	
5700A G/VI	(C57A G+5957VI)	1	057000291	235
5700A G/VG	(C57A G+5957VG)	1	057000292	258
C57A R		1	057000401	
5700A R/VI	(C57A R+5957VI)	1	057000491	235
5700A R/VG	(C57A R+5957VG)	1	057000492	258



C57B - 5700B

MasterCargo workbench

- Model with tool storage board (C57P) and two drawer cabinets.
- Drawer cabinet: five drawers with ball bearing slides to support heavy loads.
- Centralized locking system.
- Panel toolholder with two holes on the back for wall mounting.
- Aluminium shutter with safety lock.
- Three removable perforated panels for tool holding.
- Worktop made from multi-layered wood with plastic laminate finishing with three holes for a vice 1599 M125/M150/M165, to be ordered separately.



C57B O



C57B G



5700B O



C57B R

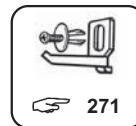
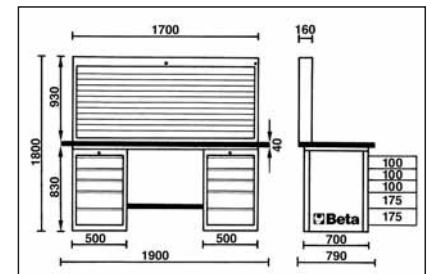

C57B O	1	057000002	
5700B O/VI (C57B O+5957VI)	1	057000093	235
5700B O/VG (C57B O+5957VG)	1	057000094	258
C57B G	1	057000202	
5700B G/VI (C57B G+5957VI)	1	057000293	235
5700B G/VG (C57B G+5957VG)	1	057000294	258
C57B R	1	057000402	
5700B R/VI (C57B R+5957VI)	1	057000493	235
5700B R/VG (C57B R+5957VG)	1	057000494	258

C57C

MasterCargo workbench

- Model with two drawer cabinets.
- Drawer cabinet: five drawers with ball bearing slides to support heavy loads.
- Centralized locking system.
- Worktop made from multi-layered wood with plastic laminate finishing with three holes for a vice 1599 M125/M150/M165, to be ordered separately.



C57C O



C57C G



C57C R

C57C O	1	057000003	
C57C G	1	057000203	
C57C R	1	057000403	

C57P - 5700P

panel toolholder Mastercargo

- Panel toolholder with two holes on the back for wall mounting.
- Aluminium shutter with safety lock.
- Three removable perforated panels for tool holding.



C57P O

1700 mm

930 mm



C57P G



5700P O/U



C57P R



C57P O		1	057000020	
5700P O/U	(C57P O+5957U)	1	057000095	240
C57P G		1	057000220	
5700P G/U	(C57P G+5957U)	1	057000295	240
C57P R		1	057000420	
5700P R/U	(C57P R+5957U)	1	057000495	240

5700LAMP

MasterCargo workbench lamp

- Sturdy sheet metal frame comprising four elements; provided with screws for assembling the lamp.
- Lamp holder with fluorescent tube, 36W.
- Power supply 230V.
- Provided without wire.



5700LAMP

1 057000005

5700LAMP + 5700A O

C58A - 5800A

workbench with Basic toolholder

- Drawer cabinet: six drawers on slides with centralized locking system.
- Two fixed perforated panels for arranging the tools.
- Can be fixed to the wall.
- Multi-ply wood worktop with laminated plastic finishing.
- Two holes suitable for a vice 1599 M100 (to be ordered separately).



C58A

5800A/U

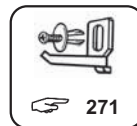
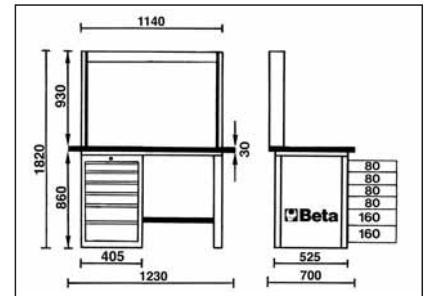

C58A		1	058000001	
5800A/U	(C58A+5958U)	1	058000091	241

C58B - 5800B

workbench with BasicPlus toolholder

Drawer cabinet: six drawers on slides with centralized locking system.

The BasicPlus model has same features as the Basic but with a shutter on the panel toolholder. Sheet steel frame.

Multi-ply wood worktop with laminated plastic finishing. Two holes suitable for a vice 1599 M100 (to be ordered separately).



C58B

5800B/U

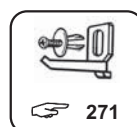
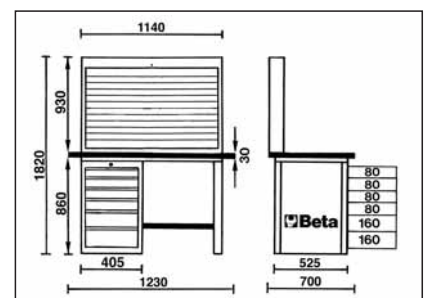

C58B		1	058000002	
5800B/U	(C58B+5958U)	1	058000092	241

C58C

workbench

- Can match panel toolholders C58P/A and C58P/B.
- Drawer cabinet: six drawers on slides with centralized locking system.
- Multi-ply wood worktop with laminated plastic finishing.
- Two holes suitable for a vice 1599 M100 (to be ordered separately).



C58C

1 058000003

C58P/A - 5800UP/A

panel toolholder Basic

- Open panel



C58P/A

1140 mm

930 mm

C58P/A

1 058000020

5800P/AU (C58P/A+5958U)

1 058000096 241

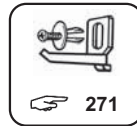

271



5800UP/A

C58P/B - 5800UP/B

panel toolholder BasicPlus

- Security locked shutter.



C58P/B

1140 mm

930 mm

C58P/B

1 058000021

5800P/BU (C58P/B+5958U)

1 058000097 241



271



5800UP/B

C56M

workbench

- Worktop made from both slip-proof aluminium sheet and rubber mat.
- Load capacity: kg.800.
- Can match panel toolholder C57P.
- Three drawers with lock.
- Can be fixed to the floor.



C56M O



C56M G



C56M R

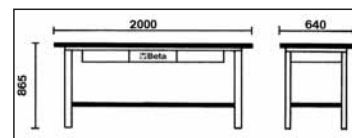

C56M O	1	056000050
C56M G	1	056000053
C56M R	1	056000054

C58M

workbench

- Metal worktop fully covered with a removable antislip rubber mat.
- Lower shelf made from solid wood.
- Static load capacity: 2 t.
- Can match panel tool holder C58P; cannot be fixed to the worktop.
- 2 drawers with locks.
- Can be fixed to the floor.
- Aluminium worktop item C58M/PA available on request.

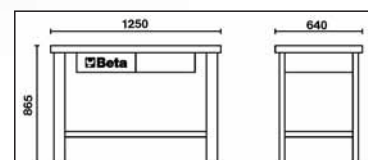

C58M	1	058000300
------	---	-----------

C58M/PA

knurled aluminium worktop
for workbench item C58M



C58M/PA	1	058000350
---------	---	-----------

 **Beta**

Tool assortments for storage units

ATTENTION!







Many of the assortments on the next few pages have undergone

the following changes:







- introduction of new tools
- rationalisation of tools.

Therefore, we recommend you thoroughly examine assortments and take a look at the features of the reference item.







For industrial maintenance

Beta N.	N° of pieces				Beta N.	N° of pieces			
5902VI	105	1	059020031	227	5908VI/2T	232	1	059080085	232
5904VI/1T	98	1	059040141	228	5910VI/3	300	1	059100042	233
5904VI/2T	145	1	059040142	229	5953VI	137	1	059530070	234
5904VI/3	172	1	059040146	230	5954VI	115	1	059540070	234
5908VI/1	195	1	059080080	231	5957VI	166	1	059570014	235







For universal maintenance

Beta N.	N° of pieces				Beta N.	N° of pieces			
5915VU/1	45	1	059150164	236	5915VU/AS	71	1	059150171	239
5915VU/2	49	1	059150167	237	5938U/2	160	1	059380050	240
5915VU/3	75	1	059150166	238	5957U	132	1	059570016	240
5915VU/4	80	1	059150185	239	5958U	86	1	059580014	241



For electronic, electrotechnical and plumbing maintenance

Beta N.	N° of pieces				Beta N.	N° of pieces			
5980ET/1	58	1	059800131	241	5980EL/1	57	1	059800137	243
5980ET/2	69	1	059800132	242	5980EL/2	98	1	059800138	243
5980MQ	44	1	059800123	242	5980ID	35	1	059800121	244

For car repair, earth moving machinery

Beta N.	N° of pieces				Beta N.	N° of pieces			
5902MT	106	1	059020033	245	5905VG/1	94	1	059050057	252
5902MT/AS	99	1	059020034	246	5905VG/2	118	1	059050043	252
5904VG/1T	90	1	059040154	247	5908VG/1	171	1	059080090	253
5904VG/2T	99	1	059040151	248	5908VG/2	208	1	059080095	254
5904VG/3	132	1	059040152	249	5910VG/3	316	1	059100046	255
5904VG/4T	135	1	059040153	250	5953VG	147	1	059530080	256
5904VG/5T	160	1	059040160	251	5954VG	138	1	059540080	257
5905VG/0	90	1	059050061	251	5957VG	185	1	059570015	258

For motorcycle repairs

Beta N.	N° of pieces			
5940M2	139	1	059400051	256

5902VI

Assortment of 105 tools

Industrial maintenance



Quantity/Description

Beta N.

4	pin punches 3 - 4 - 5 - 8 mm	31
1	centre punch 3 mm	32
1	flat chisel, ribbed type 200 mm	35
26	combination wrenches 6-32 mm	42/S26
12	double open end wrenches 6x7 - 8x9 - 10x11 - 12x13 - 14x15 - 16x17 - 18x19 - 20x22 - 21x23 - 24x26 - 25x28 - 30x32 mm	55/S12
9	offset hexagon key wrenches 1.5 - 2 - 2.5 - 3 - 4 - 5 - 6 - 8 - 10 mm	96N/SP9
1	adjustable wrench with scale, 200 mm	111
13	1/2" square drive bi-hex sockets with rail, 10-22 mm	920B/SB13
1	1/2" drive extension bar, 125 mm	920/21
1	1/2" drive extension bar, 255 mm	920/22
1	1/2" drive universal joint	920/25
1	1/2" drive sliding T-handle	920/42
1	1/2" drive reversible ratchet	920/55
1	slip joint pliers 240 mm	1048
1	adjustable self locking pliers 240 mm	1052
1	heavy duty diagonal cutting nippers 160 mm	1084BM
1	compound leverage shears, straight blades, 250 mm	1122
1	electrician's scissors, straight blades	1128BMX
1	combination pliers 180 mm	1150BM
1	half-round needle nose pliers 160 mm	1166BM
8	screwdrivers for slotted head screws, 2.5x50 - 3x75 - 3.5x100 - 4x125 - 5.5x125 - 6.5x150 - 8x200 - 10x200 mm	1260
4	screwdrivers for cross head Phillips® screws PH0x60 - PH1x80 - PH2x100 - PH3x150 mm	1262
1	engineer's hammer 500 g	1370
1	dead blow hammer Ø 40 mm	1392
1	engineer's scriber	1688A
1	measuring tape 5 m	1691A/5
1	feeler gauge, 20 blades	1708/20
5	second cut files 200 mm	1719BMA/S5
1	hacksaw frame, aluminium handle	1726BM
1	metal oil can 300 cc	1751
1	utility knife	1771BM
1	magnetic LED lamp, articulated	1837

5902VI 059020031



2200S-O/VI
(C22S-O+5902VI) 022000521



2200S-G/VI
(C22S-G+5902VI) 022000522



2200S-R/VI
(C22S-R+5902VI) 022000523



2300S-O/VI
(C23S-O+5902VI) 023000551



2300S-G/VI
(C23S-G+5902VI) 023000552



2300S-R/VI
(C23S-R+5902VI) 023000553



2300SC-O/VI
(C23SC O+5902VI) 023000581



2300SC-G/VI
(C23SC G+5902VI) 023000582



2300SC-R/VI
(C23SC R+5902VI) 023000583



2500/VI1
(C25+5902VI) 025000069

5904VI/1T

Assortment of 98 tools

Industrial maintenance



Quantity/Description

Beta N.

2	flat chisels, ribbed type 100 - 200 mm	35
21	combination wrenches 6-22 - 24 - 27 - 30 - 32 mm	42
8	double open end wrenches 6x7 - 8x9 - 10x11 - 12x13 - 14x15 - 16x17 - 18x19 - 20x22 mm	55
9	offset hexagon key wrenches 1.5 - 2 - 2.5 - 3 - 4 - 5 - 6 - 8 - 10 mm	96/SP9
19	1/2" square drive hexagon sockets 10-24 - 26 - 27 - 30 - 32 mm	920A
5	1/2" drive, socket drivers for hexagon screws 5 - 6 - 8 - 10 - 12 mm	920ME
1	1/2" drive extension bar, 125 mm	920/21
1	1/2" drive extension bar, 255 mm	920/22
1	1/2" drive universal joint	920/25
1	1/2" drive sliding T-handle	920/42
1	1/2" drive reversible ratchet	920/55
6	T-handle wrenches with hexagon male ends 2.5 - 3 - 4 - 5 - 6 - 8 mm	951
1	circclip pliers straight, internal 180 mm	1032
1	circclip pliers bent, internal 170 mm	1034
1	circclip pliers straight, external 175 mm	1036
1	circclip pliers bent, external 175 mm	1038
1	slip joint pliers 240 mm	1048
1	adjustable self locking pliers 240 mm	1052
1	heavy duty diagonal cutting nippers 160 mm	1084BM
1	combination pliers 180 mm	1150BM
1	half-round needle nose pliers 160 mm	1166BM
4	screwdrivers for slotted head screws 3x75 - 4x100 - 5.5x150 - 6.5x150 mm	1260
3	screwdrivers for cross head Phillips® screws PH0x60 - PH1x80 - PH2x100 mm	1262
1	engineer's hammer 300 g	1370
1	soft face hammer Ø 35 mm	1390
5	second cut files 200 mm	1719BMA/SS

5904VI/1T 059040141



2300ST-O-VI1T 023000621
(C23ST O+5904VI/1T)



2300ST-G-VI1T 023000622
(C23ST G+5904VI/1T)



2300ST-R-VI1T 023000623
(C23ST R+5904VI/1T)



2400S5-O-VI1T 024002501
(C24S5/O+5904VI/1T)



2400S5-G-VI1T 024002502
(C24S5/G+5904VI/1T)



2400S5-R-VI1T 024002503
(C24S5/R+5904VI/1T)



2400S6-O-VI1T 024002611
(C24S6/O+5904VI/1T)



2400S6-G-VI1T 024002612
(C24S6/G+5904VI/1T)



2400S6-R-VI1T 024002613
(C24S6/R+5904VI/1T)



3600 O-5-VI1T 036000201
(C36 O/5+5904VI/1T)



3600 G-5-VI1T 036000202
(C36 G/5+5904VI/1T)



3600 R-5-VI1T 036000203
(C36 R/5+5904VI/1T)



3900 O-6-VI1T 039000111
(C39 O/6+5904VI/1T)



3900 G-6-VI1T 039000112
(C39 G/6+5904VI/1T)



3900 R-6-VI1T 039000113
(C39 R/6+5904VI/1T)

5904VI/2T

Assortment of 145 tools

Industrial maintenance



Quantity/Description

Beta N.

5	pin punches 2 - 3 - 4 - 5 - 6 mm	31
1	centre punch 4 mm	32
2	flat chisels, ribbed type 100 - 200 mm	35
21	combination wrenches 6-22 - 24 - 27 - 30 - 32 mm	42
12	double open end wrenches 6x7 - 8x9 - 10x11 - 12x13 - 14x15 - 16x17 - 18x19 - 20x22 - 21x23 - 24x26 - 27x29 - 30x32 mm	55
9	offset hexagon key wrenches 1.5 - 2 - 2.5 - 3 - 4 - 5 - 6 - 8 - 10 mm	96N/SP9
13	1/4" hexagon sockets 4-14 mm	900
6	1/4" socket drivers for hexagon screws 2.5-8 mm	900ME
1	1/4" drive extension bar 50 mm	900/20
1	1/4" drive extension bar 150 mm	900/21
1	1/4" drive universal joint	900/25
1	1/4" drive spinner handle	900/30
1	1/4" drive swivel T-handle	900/42
1	1/4" reversible ratchet	900/55
19	1/2" square drive hexagon sockets 10-24 - 26 - 27 - 30 - 32 mm	920A
5	1/2" drive, socket drivers for hexagon screws 5 - 6 - 8 - 10 - 12 mm	920ME
1	1/2" drive extension bar, 125 mm	920/21
1	1/2" drive extension bar, 255 mm	920/22
1	1/2" drive universal joint	920/25
1	1/2" drive sliding T-handle	920/42
1	1/2" drive reversible ratchet	920/55
6	T-handle wrenches with hexagon male ends 2.5 - 3 - 4 - 5 - 6 - 8 mm	951
1	circlip pliers straight, internal 180 mm	1032
1	circlip pliers bent, internal 170 mm	1034
1	circlip pliers straight, external 175 mm	1036
1	circlip pliers bent, external 175 mm	1038
1	slip joint pliers 240 mm	1048
1	adjustable self locking pliers 240 mm	1052
1	heavy duty diagonal cutting nippers 160 mm	1084BM
1	tin snips 240 mm	1112
1	electrician's scissors, straight blades	1128BM
1	combination pliers 180 mm	1150BM
1	half-round needle nose pliers 160 mm	1166BM
7	screwdrivers for slotted head screws 2.5x50 - 3x75 - 3.5x100 - 4x125 - 5.5x100 - 5.5x150 -	1260
6	screwdrivers for cross head Phillips® screws PH0x60 - PH0x100 - PH1x80 - PH1x120 - PH2x100	1262
1	engineer's hammer 300 g	1370
1	soft face hammer Ø 35 mm	1390
5	second cut files 200 mm	1719BMA/S5
1	hacksaw frame, aluminium handle	1726
5	blades for hacksaw	1728BM
1	riveting pliers	1741B
100	aluminium rivets 2.9x6 mm	1741RV
100	aluminium rivets 3.2X8 mm	1741RV
100	aluminium rivets 3.8x10 mm	1741RV
100	aluminium rivets 4x12 mm	1741RV
100	aluminium rivets 4.8x12 mm	1741RV
1	plastic oil can 200 cc	1753
1	empty thermoformed tray	VP5

5904VI/2T 059040142



2400S7-O/VI2T 024002701
(C24S7/O+5904VI/2T)



2400S7-G/VI2T 024002702
(C24S7/G+5904VI/2T)



2400S7-R/VI2T 024002703
(C24S7/R+5904VI/2T)



2400S8-O/VI2T 024002801
(C24S8/O+5904VI/2T)



2400S8-G/VI2T 024002802
(C24S8/G+5904VI/2T)



2400S8-R/VI2T 024002803
(C24S8/R+5904VI/2T)



3600 O-7/VI2T 036000221
(C36 O/7+5904VI/2T)



3600 G-7/VI2T 036000222
(C36 G/7+5904VI/2T)



3600 R-7/VI2T 036000223
(C36 R/7+5904VI/2T)



3900 O-8/VI2T 039000171
(C39 O/8+5904VI/2T)



3900 G-8/VI2T 039000172
(C39 G/8+5904VI/2T)



3900 R-8/VI2T 039000173
(C39 R/8+5904VI/2T)



3900 O-7/VI2T 039000131
(C39 O/7+5904VI/2T)



3900 G-7/VI2T 039000132
(C39 G/7+5904VI/2T)



3900 R-7/VI2T 039000133
(C39 R/7+5904VI/2T)

5904VI/3

Assortment of 172 tools

Industrial maintenance



Quantity/Description

Beta N.

6	pin punches 2 - 3 - 4 - 5 - 6 - 8 mm	31/B6
1	centre punch 4 mm	32
2	flat chisels, ribbed type 125 - 250 mm	35
1	cape chisel, ribbed type 150 mm	37
26	combination wrenches 6-32 mm	42/S26
13	double open end wrenches 6x7 - 8x9 - 10x11 - 12x13 - 14x15 - 16x17 - 18x19 - 20x22 - 21x23 - 24x26 - 25x28 - 27x29 - 30x32 mm	55/S13
10	offset hexagon key wrenches 1.5 - 2 - 2.5 - 3 - 4 - 5 - 6 - 8 - 10 - 12 mm	96N/B10
1	adjustable wrench 250 mm	110
13	1/2" square drive bi-hex sockets with rail, 10-22 mm	920B/SB13
8	1/2" square drive bi-hex sockets with rail, 23-32 mm	920B/SB8
7	1/2" square drive, socket drivers with rail, 5-17 mm	920ME/SB7
1	1/2" drive extension bar, 125 mm	920/21
1	1/2" drive extension bar, 255 mm	920/22
1	1/2" drive universal joint	920/25
1	1/2" drive swivel T-handle	920/40
1	1/2" drive sliding T-handle	920/42
1	1/2" drive push-through square ratchet	920/50
8	double ended bi-hex tubular socket wrenches 6x7-20x22 mm	930/S8
14	T-handle wrenches with hexagon male ends 2-14 mm	951/S14
1	flat nose pliers 160 mm	1008BM
2	circclip pliers straight, internal 180 - 225 mm	1032
1	circclip pliers bent, internal 170 mm	1034
2	circclip pliers straight, external 175 - 225 mm	1036
1	circclip pliers bent, external 175 mm	1038
1	slip joint pliers 240 mm	1048
1	self locking pliers, double adjustment	1051
1	heavy duty diagonal cutting nippers 160 mm	1084BM
1	toggle lever assisted end cutting nippers 180 mm	1092V
1	compound leverage shears, straight blades, 250 mm	1122
1	electrician's scissors, straight blades	1128BMX
1	combination pliers 180 mm	1150BM
1	bent needle nose pliers 160 mm	1168BM
4	screwdrivers for slotted head screws 5.5x100 - 6.5x150 - 8x200 - 10x200 mm	1260
4	screwdrivers for cross head Phillips® screws PH0x60 - PH1x80 - PH2x100 - PH3x150 mm	1262/S4
4	screwdrivers for headless slotted screws 2.5x60 - 3x100 - 4x100 - 5x125 mm	1264
13	drivers for Torx® head screws, with handles, T6+T45	1267TX/S13
1	engineer's hammer, 500 g	1370
1	soft face hammer Ø 45 mm	1390
1	vernier caliper	1650
1	semirigid stainless steel rule 300 mm	1683
1	measuring tape 5 m	1691A/5
1	feeler gauge, 20 blades	1708/20
1	flexible magnetic pick-up tool 1.8 kg	1712E/2
5	second cut files 200 mm	1719BMA/S5
1	hacksaw frame, aluminium handle	1726BM
1	metal oil can 300 cc	1751
1	magnetic LED lamp, articulated	1837

5904VI/3

059040146



2400S7-O/VI3

(C24S7/O+5904VI/3)

024002711



2400S7-G/VI3

(C24S7/G+5904VI/3)

024002712



2400S7-R/VI3

(C24S7/R+5904VI/3)

024002713



2400SL-O/VI3

(C24SL/O+5904VI/3)

024002401



2400SL-G/VI3

(C24SL/G+5904VI/3)

024002402



2400SL-R/VI3

(C24SL/R+5904VI/3)

024002403

5908VI/1

Assortment of 195 tools

Industrial maintenance



5908VI/1 059080080



2800N O/V11 028000311
(C28N O+5908VI/1)



2800N G/V11 028000312
(C28N G+5908VI/1)



2800N R/V11 028000313
(C28N R+5908VI/1)



3000VI1 030000071
(C30+5908VI/1)

Quantity/Description

Beta N.

6	pin punches, Ø 2 - 3 - 4 - 5 - 6 - 8 mm	31/B6
1	centre punch, Ø 4 mm	32
2	flat chisels, ribbed type, 125 - 250 mm	35
1	cape chisel, ribbed type, 200 mm	37
30	combination wrenches, 6+32 - 35 - 36 - 38 - 41 mm	42
14	double open end wrenches, 6x7 - 8x9 - 10x11 - 12x13 - 14x15 - 16x17 - 18x19 - 20x22 - 21x23 - 24x26 - 25x28 - 27x29 - 30x32 - 36x41 mm	55
13	heavy duty offset ring wrenches, 6x7 - 8x9 - 10x11 - 12x13 - 14x15 - 16x17 - 18x19 - 20x22 - 21x23 - 24x26 - 25x28 - 27x29 - 30x32 mm	90
10	offset hexagon key wrenches, 1.5+12 mm	96N/B10
4	offset hexagon key wrenches, 13 - 14 - 17 - 19 mm	96N
1	adjustable wrench with scale, 200 mm	111
13	1/2" square drive bi-hex sockets with rail, 10+22 mm	920B/SB13
8	1/2" square drive bi-hex sockets with rail, 23+32 mm	920B/SB8
7	1/2" square drive socket drivers with rail, 5 - 6 - 8 - 10 - 12 - 14 - 17 mm	920ME/SB7
1	1/2" square drive extension bar - 125 mm	920/21
1	1/2" square drive extension bar - 255 mm	920/22
1	1/2" drive universal joint	920/25
1	1/2" drive swivel T-handle	920/40
1	1/2" drive sliding T handle	920/42
1	1/2" push-through drive ratchet	920/50
12	double ended hexagon / bi-hex offset socket wrenches, 8 - 10 - 11 - 13 - 14 - 17 - 19 - 22 - 24 - 27 - 30 - 32 mm	932
5	T handle wrenches with swivelling hexagon male ends, 3 - 4 - 5 - 6 - 8 mm	953
1	straight, flat nose pliers, 160 mm	1008BM
3	internal circlip pliers, straight pattern, 180 - 225 - 300 mm	1032
3	internal circlip pliers, bent pattern, 170 - 210 - 290 mm	1034
3	external circlip pliers, straight pattern, 140x1.3 - 175 - 225 mm	1036
3	external circlip pliers, bent pattern, 135x1.3 - 175 - 220 mm	1038
2	slip joint pliers, boxed joints, 240 - 300 mm	1048
1	double adjustment self-locking pliers	1051
1	heavy duty diagonal cutting nippers, 160 mm	1084BM
1	toggle lever assisted end cutting nippers, 180 mm	1092V
1	compound leverage shears, straight blades, 250 mm	1122
1	electrician's scissors, straight blades	1128BMX
1	combination pliers, 180 mm	1150BM
1	curved nose pliers, 160 mm	1168BM
11	screwdrivers for slotted head screws, 2.5x50 - 3x75 - 3.5x100 - 4x125 - 5.5x125 - 5.5x150 - 6.5x100 - 6.5x150 - 8x150 - 10x200 - 12x250 mm	1260
5	screwdrivers for cross head Phillips® screws, PH0x60 - PH1x80 - PH2x100 - PH3x150 - PH4x200 mm	1262
2	screwdrivers for slotted head screws, extra-short series, 4x30 - 6.5x30 mm	1260N
2	screwdrivers for cross head Phillips® screws, extra-short series, PH1x30 - PH2x30 mm	1262N
2	engineer's hammers, 300 - 600 g	1370
2	soft face hammers, Ø 35 - 60 mm	1390
1	two-leg universal puller, 25+130 mm	1500N/2
1	two-leg universal puller, 80+250 mm	1500N/5
1	workshop vernier	1650
1	semirigid rule, 300 mm	1683
1	engineer's scriber	1688A
1	measuring tape, 5 m	1691A/5
1	metric feeler gauge, 13 blades	1708/13
1	flexible magnetic pickup tool, 1.8 kg	1712E/2
5	second cut files, 200 mm	1719BMA/S5
1	hacksaw frame	1726BM
1	metal pressure oil can, 200 cc	1751
1	magnetic LED lamp, articulated	1837

5908VI/2T

Assortment of 232 tools

Industrial maintenance

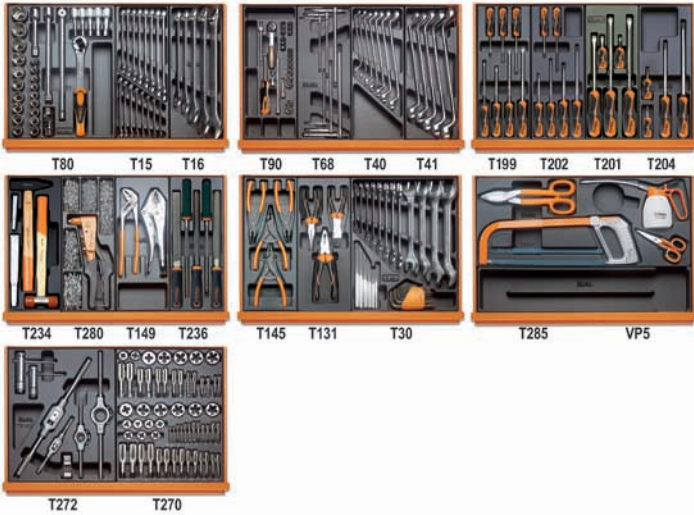

5908VI/2T 059080085



2800N O/VI2T 028000321
(C28N O+5908VI/2T)



2800N G/VI2T 028000322
(C28N G+5908VG/2T)



2800N R/VI2T 028000323
(C28N R+5908/VI2T)

Quantity/Description	Beta N.
5 pin punches 2 - 3 - 4 - 5 - 6 mm	31
1 centre punch 4 mm	32
2 flat chisels, ribbed type 100 - 200 mm	35
21 combination wrenches 6-22 - 24 - 27 - 30 - 32 mm	42
12 double open end wrenches 6x7 - 8x9 - 10x11 - 12x13 - 14x15 - 16x17 - 18x19 - 20x22 - 21x23 - 24x26 - 27x29 - 30x32 mm	55
12 offset ring wrenches 6x7 - 8x9 - 10x11 - 12x13 - 14x15 - 16x17 - 18x19 - 20x22 - 21x23 - 24x26 - 25x28 - 27x29 mm	90
9 offset hexagon key wrenches 1.5 - 2 - 2.5 - 3 - 4 - 5 - 6 - 8 - 10 mm	96N/SP9
26 coarse pitch hand taps	430
M3 - 4 - 5 - 6 - 7 - 8 - 9 - 10 - 12 - 14 - 16 - 18 - 20	
14 fine pitch hand taps M6x0.75 - M8x1 - M10x1.25 - M12x1.5 - M14x1.5 - M16x1.5 - M18x1.5	433
1 adjustable tap wrench M3-M12	435/1,5
1 adjustable tap wrench M5-M21	435/3
1 reversible ratcheting tap wrench M3-M8	436/1
1 reversible ratcheting tap wrench M5-M12	436/2
7 round dies, coarse pitch M3 - 4 - 5 - 6 - 7 - 8 - 9	440
6 round dies, coarse pitch M10 - 12 - 14 - 16 - 18 - 20	440A
2 round dies, fine pitch M6x0.75 - M8x0.75	441
5 round dies, fine pitch M10x1.25 - M12x1.5 - M14x1.5 - M16x1.5 - M18x1.5	441A
1 die stock 25.4 mm	444/1
1 die stock 38.1 mm	444/2
13 1/4" hexagon sockets 4-14 mm	900
6 1/4" socket drivers for hexagon screws 2.5 - 3 - 4 - 5 - 6 - 8 mm	900ME
1 1/4" drive extension bar 50 mm	900/20
1 1/4" drive extension bar 150 mm	900/21
1 1/4" drive universal joint	900/25
1 1/4" drive spinner handle	900/30
1 1/4" drive swivel T-handle	900/42
1 1/4" reversible ratchet	900/55
19 1/2" square drive hexagon sockets 10-24 - 26 - 27 - 30 - 32 mm	920A
5 1/2" drive, socket drivers for hexagon screws 5 - 6 - 8 - 10 - 12 mm	920ME
1 1/2" drive extension bar, 125 mm	920/21
1 1/2" drive extension bar, 255 mm	920/22
1 1/2" drive universal joint	920/25
1 1/2" drive sliding T-handle	920/42
1 1/2" drive reversible ratchet	920/55
6 T-handle hexagon wrenches 2.5 - 3 - 4 - 5 - 6 - 8 mm	951
1 circlip pliers straight, internal 180 mm	1032
1 circlip pliers bent, internal 170 mm	1034
1 circlip pliers straight, external 175 mm	1036
1 circlip pliers bent, external 175 mm	1038
1 slip joint pliers 240 mm	1048
1 adjustable self locking pliers 240 mm	1052
1 heavy duty diagonal cutting nippers 160 mm	1084BM
1 tin snips 250 mm	1112
1 electrician's scissors, straight blades	1128BM
1 combination pliers 180 mm	1150BM
1 half-round needle nose pliers 160 mm	1166BM
10 screwdrivers for slotted head screws, 2.5x50 - 3x75 - 3.5x100 - 4x125 - 5.5x100 - 5.5x150 - 6.5x150 - 8x150 - 8x200 - 10x200 mm	1260
8 screwdrivers for cross head Phillips® screws PH0x60 - PH0x100 - PH1x80 - PH1x120 - PH2x100 - PH2x150 - PH3x150 - PH4x200 mm	1262
2 screwdrivers for slotted head screws, extra-short series, 4x30 - 6.5x30 mm	1260N
2 screwdrivers for cross head Phillips® screws, extra-short series, PH1x30 - PH2x30 mm	1262N
1 engineer's hammer 300 g	1370
1 soft face hammer Ø 35 mm	1390
1 screw pitch gauge ISO 0.25-6 W 62-4x1"	1707
5 second cut files 200 mm	1719BMA/S5
1 hacksaw frame, aluminium handle	1726
5 blades for hacksaw	1728BM
1 riveting pliers, 250 mm	1741B
100 aluminium rivets 2.9x6 mm	1741RV
100 aluminium rivets 3.2x8 mm	1741RV
100 aluminium rivets 3.8x10 mm	1741RV
100 aluminium rivets 4x12 mm	1741RV
100 aluminium rivets 4.8x12 mm	1741RV
1 plastic oil can 200 cc	1753
1 empty thermoformed tray	VP5

5910VI/3

Assortment of 300 tools

Industrial maintenance



5910VI/3

059100042



3000/VI3

(C30+5910VI/3)

030000082

Quantity/Description

- 6 pin punches, Ø 2 - 3 - 4 - 5 - 6 - 8 mm
- 1 centre punch, Ø 4 mm
- 2 flat chisels, ribbed type, 125 - 250 mm
- 1 cape chisel, ribbed type, 200 mm
- 4 combination wrenches 35 - 36 - 38 - 41 mm
- 26 combination wrenches 6+32 mm
- 1 double open end wrench 36x41 mm
- 13 double open end wrenches 6x7 - 8x9 - 10x11 - 12x13 - 14x15 - 16x17 - 18x19 - 20x22 - 21x23 - 24x26 - 25x28 - 27x29 - 30x32 mm
- 13 double ended deep offset ring wrenches 6x7+30x32 mm
- 4 offset hexagon key wrenches 13 - 14 - 17 - 19 mm
- 10 offset hexagon key wrenches 1.5 - 2 - 2.5 - 3 - 4 - 5 - 6 - 8 - 10 - 12 mm
- 1 adjustable wrench, 250 mm
- 1 heavy duty pipe wrench, 300 mm
- 25 twist drills with cylindrical shanks, short series, 1+13x0.5 mm
- 37 assortment of HSS taps and dies, metric thread
- 1 click-type torque wrench, 1/2" 40+200 Nm
- 13 bi-hex hand sockets, 1/2", with guide 10+22 mm
- 8 bi-hex hand sockets, 1/2", with guide 23+32 mm
- 4 socket drivers for hexagon screws 1/2" 10 - 12 - 14 - 17 mm
- 1 1/2" drive extension bar, 125 mm
- 1 1/2" drive extension bar, 255 mm
- 1 1/2" drive universal joint
- 1 1/2" drive swivel handle
- 1 1/2" drive sliding T handle
- 1 1/2" push-through drive ratchet
- 13 assortment of 9 sockets and 4 accessories 3/4"
- 12 double ended hexagon/bi-hex offset socket wrenches 8 - 10 - 11 - 13 - 14 - 17 - 19 - 22 - 24 - 27 - 30 - 32 mm
- 14 T-handle wrenches with three hexagon male ends 2+14 mm
- 5 T-handle wrenches with swivelling hexagon male ends 3 - 4 - 5 - 6 - 8 mm
- 1 long flat knurled nose pliers, 160 mm
- 3 internal circlip pliers, straight pattern, 180 - 225 - 300 mm
- 3 internal circlip pliers, bent pattern, 170 - 210 - 290 mm
- 3 external circlip pliers, straight pattern, 140x1.3 - 175 - 225 mm
- 3 external circlip pliers, bent pattern, 135x1.3 - 175 - 220 mm
- 2 slip joint pliers, boxed joints, 240 - 300 mm
- 1 double adjustment self-locking pliers
- 1 heavy duty diagonal cutting nippers, 160 mm
- 1 toggle lever assisted end cutting nippers, 180 mm
- 1 tin snip, straight wide blades, 300 mm
- 1 tin snip, straight narrow blades, 200 mm
- 1 electrician's scissors, straight stainless steel blades
- 1 combination pliers, 180 mm
- 1 extra long bent needle knurled nose pliers, 160 mm
- 12 screwdrivers for slotted head screws 3x75 - 3x100 - 4x100 - 4x150 - 5.5x125 - 5.5x150 - 6.5x100 - 6.5x150 - 8x150 - 8x200 - 10x200 - 12x250 mm
- 2 screwdrivers for slotted head screws, extra-short series, 4x30 - 6.5x30 mm
- 9 screwdrivers for cross head Phillips® screws PH0x60 - PH0x100 - PH1x80 - PH1x120 - PH2x100 - PH2x150 - PH3x150 - PH4x200 mm
- 2 screwdrivers for cross head Phillips® screws, extra-short series, PH1x30 - PH2x30 mm
- 2 screwdrivers for cross head Phillips® screws, 1000V, PH1x80 - PH2x100 mm
- 3 screwdrivers for headless slotted screws, 1000V, 3x100 - 4x100 - 5.5x125 mm
- 2 engineer's hammers, 300 - 600 g
- 2 soft face hammers, Ø 35 - 60 mm
- 5 tapered extractors M3-M18
- 1 two-leg universal puller, 25+130 mm
- 1 two-leg universal puller, 80+250 mm
- 1 workshop vernier
- 1 semi-rigid graduated rule, 300 mm
- 1 engineer's scriber
- 1 measuring tape, 5 m
- 1 feeler gauge, 13 blades
- 1 flexible magnetic pickup tool, 1.8 kg
- 5 second cut files, 200 mm
- 1 hacksaw frame
- 1 riveting pliers
- 1 metal pressure oil can, 200 cc

Beta N.

- 31/B6
- 32
- 35
- 37
- 42
- 42/S26
- 55
- 55/S13
- 90/S13
- 96N
- 96N/B10
- 110
- 362
- 412/SP25
- 447/C37
- 606/20
- 920B/SB13
- 920B/SB8
- 920ME
- 920/21
- 920/22
- 920/25
- 920/40
- 920/42
- 920/44
- 920/50
- 928A/C9
- 932
- 951/S14
- 953
- 1008BM
- 1032
- 1034
- 1036
- 1038
- 1048
- 1051
- 1084BM
- 1092V
- 1112
- 1114
- 1128BMX
- 1150BM
- 1168BM
- 1260
- 1260N
- 1262
- 1262N
- 1272MQ
- 1274MQ
- 1370
- 1390
- 1430/S5
- 1500/2
- 1500/5
- 1650
- 1683
- 1688A
- 1691A/5
- 1708/13
- 1712E/2
- 1719BMA/S5
- 1726BM
- 1741B
- 1751

5953VI

Assortment of 137 tools

Industrial maintenance



5953VI 059530070



5300VI (C53VI+5953VI) 053000011

Quantity/Description

Quantity/Description	Beta N.
5 pin punches 2 - 3 - 4 - 5 - 6 mm	31
1 centre punch 4 mm	32
2 flat chisels, ribbed type 200 - 250 mm	35
18 combination wrenches 6-14 - 16 - 17 - 18 - 19 - 21 - 22 - 24 - 27 - 30 mm	42
12 double open end wrenches 6x7 - 8x9 - 10x11 - 12x13 - 14x15 - 16x17 - 18x19 - 20x22 - 21x23 - 24x26 - 27x29 - 30x32 mm	55
12 offset hexagon key wrenches 2-10 mm	96/SP12
1 adjustable wrench with scale, 200 mm	111
1 pipe wrench Swedish pattern 320 mm	374
20 1/2" square drive bi-hex sockets 10-24 - 26 - 27 - 28 - 30 - 32 mm	920B
6 1/2" socket drivers for hexagon screws 5 - 6 - 8 - 10 - 12 - 14 mm	920ME
1 1/2" drive extension bar, 125 mm	920/21
1 1/2" drive extension bar, 255 mm	920/22
1 1/2" drive universal joint	920/25
1 1/2" drive swivel T-handle	920/40
1 1/2" drive sliding T-handle	920/42
1 1/2" drive reversible ratchet	920/55
6 T-handle wrenches with hexagon male end 2.5 - 3 - 4 - 5 - 6 - 8 mm	951
2 circlip pliers straight, internal 140 - 180 mm	1032
1 circlip pliers bent, internal 170 mm	1034
2 circlip pliers straight, external 140x1.3 - 175 mm	1036
1 circlip pliers, bent external 175 mm	1038
1 slip joint pliers 240 mm	1048
1 adjustable self locking pliers 240 mm	1052
1 heavy duty diagonal cutting nippers 160 mm	1084BM
1 toggle lever assisted end cutting nippers 180 mm	1092V
1 tin snips 250 mm	1112
1 electrician's scissors, straight blades	1128BMX
1 combination pliers 180 mm	1150BM
1 half-round needle nose pliers 160 mm	1166BM
1 mains testing screwdriver	1253
9 screwdrivers for slotted head screws 3X75 - 4x100 - 4X150 - 5.5x100 - 5.5X150 - 6.5X150 - 8X150 - 10X200 - 12x250 mm	1260
2 screwdrivers for slotted head screws, extra-short series, 4x30 - 6.5x30 mm	1260N
8 screwdrivers for cross head Phillips® screws PH0x60 - PH0x100 - PH1x80 - PH1x120 - PH2x1000 - PH2x150 - PH3x150 - PH4X200 mm	1262
2 screwdrivers for cross head Phillips® screws, extra-short series, PH1x30 - PH2x30 mm	1262N
2 engineer's hammers 300 - 500 g	1370
1 soft face hammer Ø 45 mm	1390
1 flexible magnetic pick-up tool 0.5 kg	1712E/1
5 second cut files 200 mm	1719BMA/S5
1 hacksaw frame, aluminium handle	1726BM
1 plastic oil can, flexible spout 250 cc	1754

5954VI

Assortment of 115 tools

Industrial maintenance



5954VI 059540070



5400 O/VI (C54VI O+5954VI) 054000170



5400 G/VI (C54VI G+5954VI) 054000172



5400 R/VI (C54VI R+5954VI) 054000174

Quantity/Description

Quantity/Description	Beta N.
2 drift punches 2 - 3 mm	30
5 pin punches 2 - 3 - 4 - 5 - 6 mm	31
1 centre punch 4 mm	32
1 flat chisel, standard type 150 mm	34
1 cape chisel, standard type 150 mm	36
18 combination wrenches 6-22 - 24 mm	42
12 double open end wrenches 6x7 - 8x9 - 10x11 - 12x13 - 14x15 - 16x17 - 18x19 - 20x22 - 21x23 - 24x27 - 25x28 - 30x32 mm	55/S12X
12 offset hexagon key wrenches 2-10 mm	96/SP12
1 adjustable wrench 250 mm	110
20 1/2" square drive hexagon sockets 10-24 - 26 - 27 - 28 - 30 - 32 mm	920A
1 1/2" drive extension bar, 125 mm	920/21
1 1/2" drive extension bar, 255 mm	920/22
1 1/2" drive universal joint	920/25
1 1/2" drive sliding T-handle	920/42
1 1/2" drive reversible ratchet	920/55
1 circlip pliers straight, internal 180 mm	1032
1 circlip pliers bent, internal 170 mm	1034
1 circlip pliers straight, external 175 mm	1036
1 circlip pliers bent, external 175 mm	1038
1 slip joint pliers 240 mm	1048
1 adjustable self locking pliers 240 mm	1052
1 diagonal cutting nippers 160 mm	1082BM
1 tin snips 250 mm	1112
1 electrician's scissors, straight blades	1128BMX
1 combination pliers 180 mm	1150BM
1 half-round needle nose pliers 160 mm	1166BM
1 bent needle nose pliers 200 mm	1168BM
5 screwdrivers for slotted head screws 3x75 - 4x125 - 5.5x150 - 6.5x150 - 10x200 mm	1260
1 screwdriver for slotted head screws, extra-short series, 4x30 mm	1260N
3 screwdrivers for cross head Phillips® screws, PH0x60 - PH1x80 - PH2x100 mm	1262
1 screwdriver for cross head Phillips® screws, extra-short series, PH1x30 mm	1262N
1 engineer's hammer 400 g	1370
1 dead blow hammer Ø 35 mm	1392
1 puller with floating legs	1515/3
1 crimping pliers for insulated terminals	1602
1 measuring tape 5 m	1691A/5
1 feeler gauge, 20 blades	1708/20
1 flexible magnetic pick up tool 1.8 kg	1712E/2
5 second cut files 200 mm	1719BMA/S5
1 hacksaw frame, aluminium handle	1726BM
1 riveting pliers	1741B
1 plastic oil can, flexible spout 250 cc	1754

5957VI

Assortment of 166 tools

Industrial maintenance

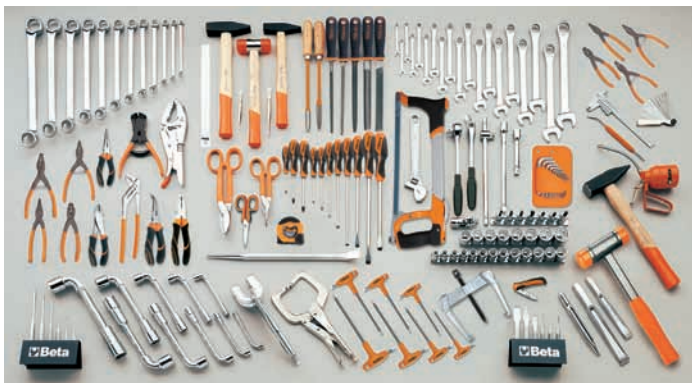

Quantity/Description

- 1 assortment of 132 tools
- 2 flat chisels, ribbed type 200 - 250 mm
- 1 cape chisel, ribbed type 200 mm
- 7 offset hexagon key wrenches with handle 2.5 - 6 mm
- 10 double ended hexagon-bi-hex offset socket wrenches 8 - 10 - 11 - 13 - 14 - 17 - 19 - 22 - 24 - 27
- 1 circlip pliers straight, internal 140 mm
- 1 circlip pliers bent, internal 130 mm
- 1 circlip pliers straight, external 140x1.3 mm
- 1 circlip pliers bent, external 135x1.3 mm
- 1 adjustable self-locking pliers 280 mm
- 1 adjustable self-locking pliers 290 mm
- 1 engineer's hammer 1000 g
- 1 dead blow hammer Ø 50 mm
- 1 universal puller 25-130 mm
- 1 vernier caliper
- 1 semirigid stainless steel rule 300 mm
- 1 engineer's scriber
- 1 feeler gauge, 13 blades
- 1 fold-away knife

Beta N.

- 5957U
- 35
- 37
- 96T/S7
- 932
- 1032
- 1034
- 1036
- 1038
- 1060
- 1062
- 1370
- 1392
- 1500N/2
- 1650
- 1683
- 1688A
- 1708/13
- 1777BM

5957VI

059570014



5700A O/VI
(C57A O+5957VI)

057000091



5700A G/VI
(C57A G+5957VI)

057000291



5700A R/VI
(C57A R+5957VI)

057000491



5700B O/VI
(C57B O+5957VI)

057000093



5700B G/VI
(C57B G+5957VI)

057000293



5700B R/VI
(C57B R+5957VI)

057000493

5915VU/1

Assortment of 45 tools

Universal use



Quantity/Description

2	drift punches Ø 2-3 mm	30
1	centre punch Ø 4 mm	32
2	flat chisels 125-150 mm	34
1	cape chisel 150 mm	36
14	combination wrenches 6-14 - 17 - 19 - 21 - 22 - 24 mm	42
9	offset hexagon key wrenches 1,5 - 2 - 2,5 - 3 - 4 - 5 - 6 - 8 - 10 mm	96/SP9
1	adjustable wrench with scale, 200 mm	111
1	slip joint pliers, boxed joints 240 mm	1048
1	diagonal cutting nippers 160 mm	1082
1	electrician's scissors, straight blades	1128BMX
1	combination pliers 180 mm	1150
1	half-round needle nose pliers 160 mm	1166
4	screwdrivers for slotted head screws 3x75 - 4x100 - 5,5x100 - 6,5x150 mm	1201
3	screwdrivers for cross head Phillips® screws PH0x60 - PH1x80 - PH2x100 mm	1202
1	engineer's hammer 300 g	1370
1	measuring tape, 5 m	1692/5
1	utility knife with snap-off blade	1771

Beta N.

5915VU/1

059150164



2109VU/1

(C9+5915VU/1)

021090011



2110VU/1

(C10+5915VU/1)

021100011



2115VU/1

(C15+5915VU/1)

021150011



2115LVU/1

(C15L+5915VU/1)

021150111



2116PVU/1

(CP16+5915VU/1)

021160021



2117PVU/1

(CP17+5915VU/1)

021170031



2117PLVU/1

(CP17L+5915VU/1)

021170131



2118VU/1

(C18+5915VU/1)

021180021

5915VU/2

Assortment of 49 tools

Universal use

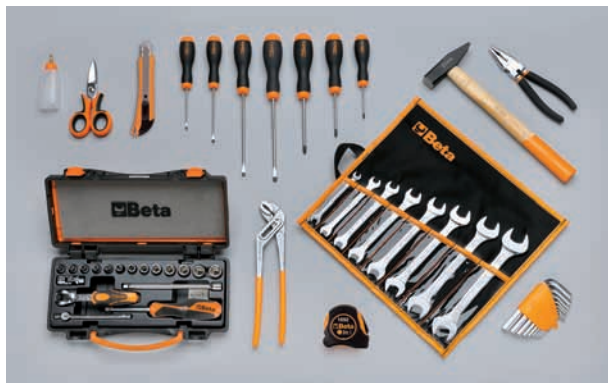

Quantity/Description

8	double open end wrenches 6x7 - 8x9 - 10x11 - 12x13 - 14x15 - 16x17 - 18x19 - 20x22 mm	55/B8
9	offset hexagon key wrenches 1.5 - 2 - 2.5 - 3 - 4 - 5 - 6 - 8 - 10 mm	96/SP9
13	hexagon hand sockets 1/4" 4+14 mm	900
1	1/4" drive extension bar, 150 mm	900/21
1	1/4" drive universal joint	900/25
1	1/4" drive spinner handle	900/30
1	1/4" drive sliding T-handle	900/42
1	1/4" drive reversible ratchet	900/55
1	slip joint pliers, boxed joints, 240 mm	1048
1	electrician's scissors, straight blades	1128BMX
1	combination pliers, 180 mm	1150
4	screwdrivers for slotted head screws, 3x75 - 4x125 - 6.5x150 mm	1201
3	screwdrivers for cross head Phillips® screws PH1x80 - PH2x100 mm	1202
1	engineer's hammer, 300 g	1370
1	measuring tape, 3 m	1692/3
1	plastic oil bottle, 30 cc	1755
1	snap-off blade utility knife, 18 mm	1771

Beta N.

5915VU/2

059150167



2014N/VU2

(2014N/VV+5915VU/2)

020140019



2116PVU/2

(CP16+5915VU/2)

021160022



2120VU/2

(C20+5915VU/2)

021200012



2120LVU/2

(C20L+5915VU/2)

021200112



2034VU/2

(2034/VV+5915VU/2)

020340006

5915VU/3

Assortment of 75 tools

Universal use



Quantity/Description

Quantity/Description	Beta N.
1 pin punch 4 mm	31
1 pin punch 4 mm	31
1 centre punch 4 mm	32
1 flat chisel, standard type 150 mm	34
15 combination wrenches 6-17 - 19 - 22 - 24 mm	42
9 offset hexagon key wrenches 1.5-10 mm	96/SP9
3 offset hexagon key wrenches, with high torque handles 4 - 5 - 6 mm	96T
1 adjustable wrench with scale, 200 mm	111
13 1/2" square drive hexagon sockets 8-17 - 19 - 22 - 24 mm	920A
1 1/2" drive extension bar, 255 mm	920/22
1 1/2" drive universal joint	920/25
1 1/2" drive sliding T-handle	920/42
1 1/2" drive reversible ratchet	920/55
7 double ended hexagon tubular socket wrenches, light series 6x7 - 8x9 - 10x11 - 12x13 - 14x15 - 16x17 - 18x19 mm	935
2 tommy bars for tubular wrenches 1 - 2 mm	940
1 slip joint pliers 240 mm	1048V
1 adjustable self-locking pliers 240 mm	1052
1 heavy duty diagonal cutting nippers 160 mm	1084BM
1 electrician's scissors, straight blades	1128BMX
1 combination pliers 180 mm	1150BM
1 half-round needle nose pliers 160 mm	1166BM
4 screwdrivers for slotted head screws 3x75 - 4x100 - 5,5x150 - 6,5x150 mm	1201
3 screwdrivers for cross head Phillips® screws PH0x60 - PH1x80 - PH2x100 mm	1202
1 engineer's hammer 400 g	1370
1 measuring tape, 5 m	1692/5
1 hacksaw frame, aluminium handle	1726
1 plastic oil can, retractable spout 150 cc	1755
1 snap-off blade utility knife	1771

5915VU/3 059150166



2109VU/3 021090113
(C9+5915VU/3)



2110VU/3 021100013
(C10+5915VU/3)



2115VU/3 021150013
(C15+5915VU/3)



2115LVU/3 021150113
(C15L+5915VU/3)



2116PVU/3 021160023
(CP16+5915VU/3)



2117PVU/3 021170033
(CP17+5915VU/3)



2117PLVU/3 021170133
(CP17L+5915VU/3)



2119VU/3 021190013
(C19+5915VU/3)



2119LVU/3 021190113
(C19L+5915VU/3)



2120VU/3 021200013
(C20+5915VU/3)



2120LVU/3 021200113
(C20L+5915VU/3)



4100S/VU3 041000081
(C41S+5915VU/3)



4100H/VU3 041000091
(C41H+5915VU/3)

5915VU/4

Assortment of 80 tools

Universal use



Quantity/Description

- 1 pin punch 4 mm 31
- 1 centre punch 4 mm 32
- 1 flat chisel, standard type 150 mm 34
- 15 combination wrenches 6-17 - 19 - 22 - 24 mm 42
- 9 offset hexagon key wrenches 1.5-10 mm 96/SP9
- 1 adjustable wrench with scale, 200 mm 111
- 13 1/2" square drive hexagon sockets 8-17 - 19 - 22 - 24 mm 920A
- 1 1/2" drive extension bar, 255 mm 920/22
- 1 1/2" drive universal joint 920/25
- 1 1/2" drive sliding T-handle 920/42
- 1 1/2" drive reversible ratchet 920/55
- 17 double ended hexagon/bi-hex offset socket wrenches 6-22 mm 932/S17
- 1 slip joint pliers, boxed joints, 240 mm 1048
- 1 adjustable self-locking pliers 240 mm 1052
- 1 heavy duty diagonal cutting nippers 160 mm 1084BM
- 1 electrician's scissors, straight blades 1128BMX
- 1 combination pliers 180 mm 1150BM
- 1 half-round needle nose pliers 160 mm 1166BM
- 4 screwdrivers for slotted head screws 3x75 - 4x100 - 5.5x150 - 6.5x150 mm 1201
- 3 screwdrivers for cross head Phillips® screws PH0x60 - PH1x80 - PH2x100 mm 1202
- 1 riveting hammer 32 mm 1370F
- 1 measuring tape, 5 m 1692/5
- 1 hacksaw frame, aluminium handle 1726
- 1 plastic oil can, retractable spout 150 cc 1755
- 1 snap-off blade utility knife 1771

Beta N.

5915VU/4 059150185



2116PVU/4 (CP16+5915VU/4) 021160024



2120VU/4 (C20+5915VU/4) 021200014



2120LVU/4 (C20L+5915VU/4) 021200114

5915VU/AS

Assortment of 71 tools

Universal use



Quantity/Description

- 1 pin punch 4 mm 31
- 1 centre punch 4 mm 32
- 1 flat chisel, standard type 150 mm 34
- 13 combination wrenches 1/4 - 5/16 - 3/8 - 7/16 - 1/2 - 9/16 - 5/8 - 11/16 - 3/4 - 13/16 - 7/8 - 15/16 - 1" 42AS
- 8 offset ring wrenches 1/4"-1" 90AS/8
- 11 offset hexagon key wrenches 3/64-3/8" 96AS/B11
- 1 adjustable wrench 250 mm 111
- 13 bi-hex sockets □ 1/2", 3/8 - 7/16 - 1/2 - 9/16 - 5/8 - 19/32 - 11/16 - 3/4 - 25/32 - 13/16 - 7/8 - 15/16 - 1" 920AS
- 1 extension bar, 255 mm - 1/2" 920/22
- 1 universal joint 1/2" 920/25
- 1 1/2" drive sliding T-handle 920/42
- 1 1/2" drive reversible ratchet 920/50
- 1 slip joint pliers, boxed joints, 240 mm 1048V
- 1 adjustable self-locking pliers 240 mm 1052
- 1 heavy duty diagonal cutting nippers 160 mm 1084BM
- 1 electrician's scissors, straight blades 1128BMX
- 1 combination pliers 180 mm 1150BM
- 1 half-round needle nose pliers 160 mm 1166BM
- 4 screwdrivers for slotted head screws 3x75 - 4x100 - 5.5x150 - 6.5x150 mm 1201
- 3 screwdrivers for cross head Phillips® screws PH0x60 - PH1x80 - PH2x100 mm 1202
- 1 engineer's hammer 400 g 1370
- 1 measuring tape, 5 m 1692/5
- 1 hacksaw frame, aluminium handle 1726
- 1 plastic oil can, retractable spout 150 cc 1755
- 1 snap-off blade utility knife 1771

Beta N.

5915VU/AS 059150171



2110VU/AS (C10+5915VU/AS) 021100015



2116PVU/AS (CP16+5915VU/AS) 021160025



2120VU/AS (C20+5915VU/AS) 021200015



2120LVU/AS (C20L+5915VU/AS) 021200115

5938U/2

Assortment of 160 tools

Universal use



5938U/2 059380050



3800 O/U2 038000051
(C38 O+5938U/2)



3800 G/U2 038000052
(C38 G+5938U/2)



3800 R/U2 038000053
(C38 R+5938U/2)

Quantity/Description

Quantity/Description	Beta N.
1 drift punch Ø 3 mm	30
1 pin punch Ø 4 mm	31
1 centre punch Ø 4 mm	32
2 flat chisels, ribbed type 100 - 200 mm	35
17 combination wrenches 6 - 7 - 8 - 10 - 11 - 12 - 13 - 14 - 16 - 17 - 18 - 19 - 21 - 22 - 24 - 27 - 30 mm	42
8 double open end wrenches 6x7 - 8x9 - 10x11 - 12x13 - 14x15 - 16x17 - 18x19 - 20x22 mm	55
18 offset hexagon key wrenches 1.5+10 mm	96/SP9
11 offset hexagon key wrenches with handles 2 - 2.5 - 3 - 3.5 - 4 - 4.5 - 5 - 6 mm	910A
17 hexagon hand sockets 3/8" 6+22 mm	910/21
1 extension bar 125 mm - 3/8"	910/22
1 extension bar 250 mm - 3/8"	910/25
1 3/8" drive universal joint	910/42
1 3/8" drive sliding T-handle	910/25
1 3/8" drive reversible ratchet	910/55
19 hexagon hand sockets 1/2" 10 - 11 - 12+19 - 20 - 21 - 22 - 23 - 24 - 26 - 27 - 30 - 32 mm	920A
5 socket drivers for hexagon screws 1/2" 5 - 6 - 8 - 10 - 12 mm	920ME
1 extension bar 125 mm - 1/2"	920/21
1 extension bar 255 mm - 1/2"	920/22
1 1/2" drive universal joint	920/25
1 1/2" drive sliding T handle	920/42
1 1/2" drive reversible ratchet	920/55
6 T-handle wrenches with three hexagon male ends 2.5 - 3 - 4 - 5 - 6 - 8 mm	951
1 internal circlip pliers, straight pattern 180 mm	1032
1 internal circlip pliers, bent pattern 170 mm	1034
1 external circlip pliers, straight pattern 175 mm	1036
1 external circlip pliers, bent pattern 175 mm	1038
1 slip joint pliers 240 mm	1048
1 adjustable self-locking pliers 240 mm	1052
1 heavy duty diagonal cutting nippers 160 mm	1084BM
1 combination pliers 180 mm	1150BM
1 half-round needle nose pliers 160 mm	1166BM
7 screwdrivers for slotted head screws 2.5x50 - 3x75 - 3.5x100 - 4x125 5.5x100 - 5.5x150 - 6.5x150 mm	1201
6 screwdrivers for cross head Phillips® screws PH0x60 - PH1x80 - PH1x120 PH2x100 - PH2x150 - PH3x150 mm	1202
7 screwdrivers for Torx® head screws, with handles T6 - T7 - T8 - T9 - T10 - T15 - T20	1207TX
1 engineer's hammer 300 g	1370
1 soft face hammer Ø 35 mm	1390
1 workshop vernier	1650
1 flexible graduated rule 300 mm	1682
1 measuring tape, 5 m	1692/5
1 screw pitch gauge	1707
1 metric feeler gauge	1708/20
5 second cut files 200 mm	1719BMA/S5
1 mini hacksaw frame	1725CR
1 plastic oil bottle	1755
1 utility knife	1771
4 thermoformed trays, empty	VP3-SC
4 thermoformed trays, empty	VP-LS
4 thermoformed trays, empty	VP-LD
1 thermoformed tray, empty	VP1

5957U

Assortment of 132 tools

Universal use



5957U 059570016



5700P O/U 057000095
(C57P O+5957U)



5700P G/U 057000295
(C57P G+5957U)



5700P R/U 057000495
(C57P R+5957U)

Quantity/Description

Quantity/Description	Beta N.
6 pin punches with metal holder 2 - 3 - 4 - 5 - 6 - 8 mm	31/SP6
2 drift punches, 1 centre punch, 3 flat chisels with metal holder	38/SP6
19 combination wrenches 6-22 - 24 - 27 mm	42
12 offset ring wrenches 6x7-30x32 mm	90/S12X
12 offset hexagon key wrenches 2-10 mm	96/SP12
1 adjustable wrench 250 mm	110
1 1/2" square drive bi-hex sockets with rail, 10-22 mm	920B/SB13
8 1/2" square drive bi-hex sockets with rail, 23-32 mm	920B/SB8
4 1/2" socket drivers for slotted head screws 1.2x6.5 - 1.2x8 - 1.6x9 - 2x12 mm	920LP
3 1/2" socket drivers for Phillips® screws PH2 - 3 - 4	920PH
1 1/2" drive extension bar, 125 mm	920/21
1 1/2" drive extension bar, 255 mm	920/22
1 1/2" drive universal joint	920/25
1 1/2" drive swivel handle	920/35A
1 1/2" drive sliding T-handle	920/42
1 1/2" drive reversible ratchet	920/55
1 pry bar	963
1 bent point tweezers 120 mm	991
1 straight large point tweezers 150 mm	994
1 circlip pliers straight, internal 180 mm	1032
1 circlip pliers bent, internal 170 mm	1034
1 circlip pliers straight, external 175 mm	1036
1 circlip pliers bent, external 175 mm	1038
1 slip joint pliers 240 mm	1048
1 self locking pliers, double adjustment	1051
1 heavy duty diagonal cutting nippers 160 mm	1084BM
1 toggle lever assisted end cutting nippers 180 mm	1092V
1 tin snips, wide blades 250 mm	1112
1 tin snips, narrow blades 200 mm	1114
1 electrician's scissors, straight blades	1128BMX
1 combination pliers 180 mm	1150BM
1 half-round needle nose pliers 160 mm	1166BM
1 bent needle nose pliers 200 mm	1168BM
7 screwdrivers for slotted head screws 3x75 - 3.5x100 - 4x125 5.5x150 - 6.5x150 - 10x200 - 12x250 mm	1260
1 screwdriver for slotted head screws with hexagon bolster 12x200 mm	1260E
3 screwdrivers for cross head Phillips® screws, PH0x60 - PH1x80 - PH2x100 mm	1262
2 engineer's hammers 300-600 g	1370
1 soft face hammer Ø 35 mm	1390
1 measuring tape 5 m	1691A/5
1 flexible magnetic pick-up tool 1.8 kg	1712E/2
1 two cutting edges scraper 200 mm	1717A
1 three cutting edges scraper 200 mm	1717B
5 second cut files 200 mm	1719BMA/S5
1 hacksaw frame	1725
1 metal oil can, flexible spout 200 cc	1751

5958U

Assortment of 86 tools

Universal use



5958U 059580014



5800A/U (C58A+5958U) 058000091



5800B/U (C58B+5958U) 058000092



5800P/AU (C58P/A+5958U) 058000096



5800P/BU (C58P/B+5958U) 058000097

Quantity/Description

Quantity/Description	Beta N.
18 combination wrenches 5.5-22 mm	42
12 offset hexagon key wrenches 2-10 mm	96N/SP12
13 1/2" square drive hexagon sockets with rail, 10-22 mm	920A/SB13
8 1/2" square drive hexagon sockets with rail, 23-32 mm	920A/SB8
1 1/2" drive extension bar, 125 mm	920/21
1 1/2" drive extension bar, 255 mm	920/22
1 1/2" drive universal joint	920/25
1 1/2" drive sliding T-handle	920/42
1 1/2" drive reversible ratchet	920/55
1 circlip pliers straight, internal 180 mm	1032
1 circlip pliers straight, external 175 mm	1036
1 slip joint pliers 240 mm	1048
1 adjustable self locking pliers 240 mm	1052
1 heavy duty diagonal cutting nippers 160 mm	1084BM
1 electrician's scissors, straight blades	1128BMX
1 combination pliers 180 mm	1150BM
1 half-round needle nose pliers 160 mm	1166BM
7 screwdrivers for slotted head screws 3x75 - 3.5x100 - 4x125 - 5.5x150 - 6.5x150 - 8x200 - 10x200 mm	1260
4 screwdrivers for cross head Phillips® screws PH0x60- PH1x80- PH2x100 - PH3x150 mm	1262/54
1 engineer's hammer 300 g	1370
1 soft face hammer Ø 35 mm	1390
1 measuring tape 5 m	1691A/5
5 second cut files 200 mm	1719BMA/S5
1 hacksaw frame	1725
1 plastic oil can, flexible spout 150 cc	1754
1 snap-off blade utility knife	1771

5980ET/1

Assortment of 58 tools

Electrotechnical maintenance



5980ET/1 059800131



2011ET/1 (2011/BV+5980ET/1) 020110017



2032ET/1 (2032/VV+5980ET/1) 020320007



2034ET/1 (2034/VV+5980ET/1) 020340004

Quantity/Description

Quantity/Description	Beta N.
2 pin punches, Ø 4 - 6 mm	31
1 centre punch, Ø 4 m+F424m	32
2 flat chisels, ribbed type, 125 - 200 mm	35
8 double open end wrenches, 6x7 - 8x9 - 10x11 - 12x13 - 14x15 - 16x17 - 18x19 - 20x22 mm	55/B8
10 offset hexagon key wrenches, 1.5+12 mm	96/B10
1 adjustable wrench with scale, 200 mm	111
1 slip joint pliers, rack-type joint, 240 mm	1046
1 diagonal cutting nippers, 160 mm	1082BM
1 electrician's scissors, straight blades, with countersink	1128BSX
1 cable cutter, 170 mm	1132BM
1 wire stripping pliers, 160 mm	1142BM
1 combination pliers, 180 mm	1150BM
1 straight nose pliers, 160 mm	1166BM
1 curved nose pliers, 160 mm	1168BM
1 screwholding screwdrivers for slotted head screws, 4x125 mm	1250
1 screwholding screwdrivers for cross head Phillips® screws, PH1x150 mm	1251
1 mains testing screwdriver	1253
4 screwdrivers for slotted head screws, 2.5x75 - 3.5x100 - 5.5x125 - 12x250 mm	1260
2 screwdrivers for slotted head screws, extra-short series, 4x30 - 6.5x30 mm	1260N
1 screwdrivers for cross head Phillips® screws, extra-short series, PH2x30 mm	1262N
3 screwdrivers for cross head Phillips® screws, 1000V PH1x80 - PH2x100 - PH3x150 mm	1272MQ
4 screwdrivers for headless slotted screws, 1000V 3x100 - 4x100 - 6.5x150 - 8x175 mm	1274MQ
1 engineer's hammer, 300 g	1370
1 soft face hammer, Ø 35 mm	1390
1 crimping pliers for insulated terminals	1602
1 friction tape, 25 m	1639NS-N
1 measuring tape, 5 m	1691A/5
1 second cut file, 200 mm	1719BMA/M
1 second cut file, 200 mm	1719BMA/R
1 hacksaw frame	1725
1 foldaway knife	1777BM

5980ET/2

Assortment of 69 tools

Electrotechnical maintenance



5980ET/2 059800132



2011ET/2 (2011/BV+5980ET/2) 020110018



2029ET/2 (2029/VV+5980ET/2) 020290010



2033ET/2 (2033/VV+5980ET/2) 020330006



2036ET/2 (2036/TV+5980ET/2) 020360012

Quantity/Description

- 3 pin punches Ø 2 - 3 - 4 mm
- 1 centre punch Ø 4 mm
- 1 flat chisel, standard type 150 mm
- 8 double open end wrenches 6x7 - 8x9 - 10x11 - 12x13 - 14x15 - 16x17 - 18x19 - 20x22 mm
- 9 ball head offset hexagon key wrenches 1.5 - 2 - 2.5 - 3 - 4 - 5 - 6 - 8 - 10 mm
- 1 deburrer 150 mm
- 6 hexagon nut spinners with handles 1000V 5.5 - 6 - 7 - 8 - 10 - 13 mm
- 1 slip joint pliers 240 mm
- 1 diagonal cutting nippers 1000V 160 mm
- 1 electrician's scissors, straight blades, with countersink
- 1 cable cutter 230 mm
- 1 wire stripping pliers 160 mm
- 1 combination pliers 1000V 180 mm
- 1 half-round needle nose pliers 160 mm
- 1 mains testing screwdriver
- 2 screwdrivers for slotted head screws, extra-short series, 4x30 - 6.5x30 mm
- 1 screwdriver for cross head Phillips® screws, extra-short series, PH2x30 mm
- 3 screwdrivers for cross head Phillips® screws 1000V PH0x60 - PH1x80 - PH2x100 mm
- 4 screwdrivers for headless slotted screws 1000V 3x100 - 4x100 - 5.5x125 - 6.5x150 mm
- 1 engineer's hammer 300 g
- 1 soft face hammer Ø 35 mm
- 1 crimping pliers for insulated terminals
- 1 flexible graduated rule 250 mm
- 1 engineer's scriber 220 mm
- 1 measuring tape 5 m
- 1 spirit level, made of aluminium 200 mm
- 1 electrician's chisel 10x200 mm
- 1 chalk line reel
- 1 square flexible inspection mirror 600 mm
- 1 second cut file 200 mm
- 1 second cut file 200 mm
- 1 spring puller
- 1 hacksaw frame
- 1 bristle brush
- 1 fitting tool for nylon ties
- 1 plastic oil bottle 100 cc
- 1 nylon cable ties 3.6x200 mm (100 pz)
- 1 nylon cable ties 4.8x300 mm (100 pz)
- 1 utility knife
- 1 soldering iron 20/40W
- 1 flash light

Beta N.

- 31
- 32
- 34
- 55/B8
- 96BPC/SP9
- 345SB
- 943MQ/S6
- 1048
- 1082MQ
- 1128BSX
- 1132BM
- 1142BM
- 1150MQ
- 1166BM
- 1253
- 1260N
- 1262N
- 1272MQ
- 1274MQ
- 1370
- 1390
- 1602
- 1682
- 1688
- 1691A/5
- 1696
- 1701NE/3
- 1705
- 1715FL/A
- 1719BMA/M
- 1719BMA/R
- 1723
- 1726BM
- 1738
- 1743
- 1755
- 1748/8K
- 1748/17K
- 1771BM
- 1816A
- 1835

5980MQ

Assortment of 44 tools

Electrotechnical maintenance



5980MQ 059800123



2029MQ (2029/VV+5980MQ) 020290050

Quantity/Description

- 7 single open end wrenches, 1000V '10-12-13-14-17-19-22 mm
- 1 adjustable wrench, 1000V, 250 mm
- 6 hexagon nut spinners with handles 5.5 - 6 - 7 - 8 - 10 - 13 mm
- 4 T-handle wrenches with hexagon male ends '4-5-6-8 mm
- 1 bent knurled point spring tweezers, 1000V, '147 mm
- 1 long round nose pliers, 160 mm
- 1 diagonal cutting nippers, 1000V, 160 mm
- 1 electrician's scissors, straight blades, with countersink
- 1 wire stripping pliers, 160 mm
- 1 combination pliers, 180 mm
- 1 extra long needle nose pliers, 1000V, '160 mm
- 1 mains testing screwdriver
- 3 screwdrivers for cross head Phillips® screws, 1000V, PH1x80 - PH2x100 - PH3x150 mm
- 5 screwdrivers for headless slotted screws, 1000V, 3x100 - 4x100 - 5.5x125 - 6.5x150 - 8x175 mm
- 3 screwdrivers for cross head Pozidriv®-Supadriv® screws, 1000V, PZ0-PZ1-PZ2
- 1 soft face hammer, Ø 35 mm
- 1 inspection mirror
- 1 mini-hacksaw frame, 1000V
- 1 utility knife, 1000V
- 1 dual rating soldering iron, 20-40 W
- 1 desoldering pump
- 1 combination voltage and continuity tester

Beta N.

- 52MQ
- 110MQ
- 943MQ
- 951MQ
- 993MQ
- 1010MQ
- 1082MQ
- 1128BSX
- 1142MQ
- 1150MQ
- 1166MQ
- 1253
- 1272MQ
- 1274MQ
- 1279MQ
- 1390
- 1714
- 1725MQ
- 1777MQ
- 1816A
- 1830
- 1847

5980EL/1

Assortment of 57 tools

Electronic maintenance



5980EL/1  059800137



2032EL/1
(2032/VV+5980EL/1) 020320006



2034EL/1
(2034/VV+5980EL/1) 020340005

Quantity/Description

Quantity/Description	Beta N.
13 small double open end wrenches 4-14 mm	73/B13
9 offset hexagon key wrenches 1.5-10 mm	96N/SP9
1 bent thin knurled point spring tweezers 130 mm	991
1 straight thin knurled point pin spring tweezers 150 mm	992
1 cross tweezers 155 mm	998
1 electrician's scissors, straight blades	1128BMX
1 wire stripping pliers 160 mm	1142BM
1 half-round needle nose pliers 160 mm	1166BM
1 flat nose pliers	1172BM
1 half-round short bent nose pliers	1178BM/P
1 combination pliers	1178BM
1 diagonal flush cutting nippers	1185BM/1
1 diagonal cutting nippers	1188BM/1
1 screwholding screwdriver for slotted head screws 4x125 mm	1250
1 screwholding screwdriver for cross head Phillips® screws PH0x125 mm	1251
8 micro-screwdrivers for slotted and Phillips® head screws	1255LPH/S8
1 engineer's hammers 200 g	1370
1 measuring tape, 5 m	1692/5
1 telescopic joint inspection mirror	1715
3 needle files	1720/S3
1 spring puller	1723
1 bristle brush	1738
1 pen oiler	1756
1 snap-off utility knife	1771
1 self-locking tool	1779
1 soldering iron 40W	1814
1 de-soldering pump	1830
1 flash light	1835

5980EL/2

Assortment of 98 tools

Electronic maintenance



5980EL/2  059800138



2029EL/2
(2029/VV+5980EL/2) 020290015



2033EL/2
(2033/VV+5980EL/2) 020330004



2036EL/2
(2036/TV+5980EL/2) 020360016

Quantity/Description

Quantity/Description	Beta N.
13 small double open end wrenches 4+14 mm	73/B13
9 offset hexagon key wrenches 1.5 +10 mm	96/SP9
8 offset key wrenches for Torx® head screws T9 - T10 - T15 - T20 - T25 - T27 - T30 - T40	97TX/PL8
1 adjustable wrench with scale, 200 mm	111
18 set of 13 hexagon sockets and 5 accessories, 1/4" square drive	900/C13-5
1 straight thin knurled point spring tweezers 130 mm	990
1 bent thin knurled point spring tweezers 130 mm	991
1 extra slim short end spring tweezers, 130 mm	999A
1 electrician's scissors, straight blades	1128BMX
1 front wire stripping pliers, self-adjusting 170 mm	1149F
1 combination pliers 180 mm	1150BM
1 smooth, flat long nose pliers	1172BM
1 smooth half-round long needle nose pliers	1177BM
1 smooth half-round long bent needle nose pliers	1178BM/P
1 diagonal flush cutting nippers, rounded tips	1184BM
1 diagonal flush cutting nippers, slim tips	1186BM
1 end flush oblique cutting nippers	1191BM
8 micro-screwdrivers for slotted head screws and cross head Phillips® screws	1255LPH/S8
1 mains testing screwdriver	1253
1 screwdriver for slotted head screws, extra-short 6.5x30 mm	1290N
3 screwdrivers for cross head Phillips® screws PH0x60 - PH1x80 - PH2x100 mm	1292
2 screwdrivers for cross head Phillips® screws, extra-short PH1x30 - PH2x30 mm	1292N
5 screwdrivers for headless slotted screws 2.5x60 - 3x75 - 4x100 - 5x125 - 6.5x150 mm	1294
1 engineer's hammer 200 g	1370
1 flexible graduated rule 150 mm	1682
1 engineer's scriber 220 mm	1688
1 measuring tape 5 m	1691A/5
1 telescopic joint inspection mirror 670 mm	1715
1 needle files ●	1720R
1 needle files ▲	1720T
1 needle files ▽	1720P
1 spring puller	1723
1 bristle brush	1738
1 pen oiler	1756
1 utility knife	1771BM
1 foldaway knife	1777BM
1 self-locking round end knurled tool	1779
1 soldering iron 20/40W	1816A
1 desoldering pump	1830
1 flash light	1835

5980ID

Assortment of 35 tools

Plumbing maintenance**Quantity/Description**

- 1 flat chisel, standard type 150 mm
- 1 flat chisel, ribbed type 200 mm
- 12 double open end wrenches 6x7 - 8x9 - 10x11 - 12x13 - 14x15 - 16x17
18x19 - 20x22 - 21x23 - 24x27 - 25x28 - 30x32 mm
- 1 adjustable wrench with scale, 200 mm
- 1 pipe cutter for copper and light alloy pipes Ø 3+30 mm
- 1 pipe wrench, Swedish pattern 320 mm
- 1 slip joint pliers 240 mm
- 1 adjustable self-locking pliers 240 mm
- 1 tin snips, straight wide blades 300 mm
- 1 electrician's scissors, straight blades
- 1 combination pliers 180 mm
- 4 screwdrivers for slotted head screws 3x75 - 4x100 - 5.5x150 - 8x150 mm
- 2 screwdrivers for cross head Phillips® screws PH1x80 - PH2x100 mm
- 1 engineer's hammer 300 g
- 1 measuring tape, made of fibre 2 m
- 1 measuring tape, 5 m
- 1 spirit level, made of aluminium 200 mm
- 1 second cut file 200 mm
- 1 hacksaw frame
- 1 brake shoe cleaning brush plastic handle steel wires

Beta N.

- 34
- 35
- 55/S12X
- 111
- 334
- 374
- 1048
- 1052
- 1112
- 1128BMX
- 1150BM
- 1201
- 1202
- 1370
- 1690F
- 1692/5
- 1696A
- 1719BMA/M
- 1725
- 1737NX

5980ID

059800121

**2009ID**
(2009N/BV+5980ID)

020090011

5902MT

Assortment of 106 tools for agricultural, building and earth-moving machinery

Car repairs



Quantity/Description

Quantity/Description	Beta N.
2 drift punches 3 - 4 mm	30
2 pin punches 6 - 8 mm	31
1 centre punch 4 mm	32
2 flat chisels, ribbed type 150 - 200 mm	35
18 combination wrenches 6-14 - 17 - 19 - 22 - 24 - 27 - 30 - 32 - 36 - 41 mm	42
10 offset ring wrenches 6x7 - 8x9 - 10x11 - 12x13 - 14x15 - 16x17 18x19 - 20x22 - 24x27 - 30x32 mm	90
10 offset hexagon key wrenches 1.5-12 mm	96N/B10
17 1/2" square drive hexagon sockets 10-22 - 24 - 27 - 30 - 32 mm	920A
1 1/2" drive extension bar, 125 mm	920/21
1 1/2" drive extension bar, 255 mm	920/22
1 1/2" drive universal joint	920/25
1 1/2" drive sliding T-handle	920/42
1 1/2" drive push-through square ratchet	920/50
11 3/4" square drive hexagon socket 22 - 24 - 27 - 30 - 32 - 36 - 41 - 46 - 50 - 55 - 60 mm	928A
1 3/4" drive extension bar, 200 mm	928/21
1 3/4" drive swivel handle	928/36A
1 3/4" drive sliding T-handle	928/42
1 3/4" drive reversible ratchet	928/55
1 pry bar	964
1 slip joint pliers 240 mm	1048
1 adjustable self locking pliers, curved jaws	1055
1 heavy duty diagonal cutting nippers 160 mm	1084BM
1 electrician's scissors, straight blades	1128BMX
1 combination pliers 180 mm	1150BM
1 half-round needle nose pliers 160 mm	1166BM
4 screwdrivers for slotted head screws with hexagon bolsters 5.5x125 - 6.5x150 - 10x175 - 12x200 mm	1260E
3 screwdrivers for cross head Phillips® screws with hexagon bolsters PH2x150 - PH3x175 - PH4x200 mm	1262E
1 ball pein hammer 900 g	1377
1 soft face hammer Ø 35 mm	1390
1 feeler gauge, 20 blades	1708/20
1 three cutting edges scraper 200 mm	1717B
5 second cut files 200 mm	1719BMA/S5
1 hacksaw frame	1725

5902MT 059020033



2200S-O/MT 022000531
(C22S-O+5902MT)



2200S-G/MT 022000532
(C22S-G+5902MT)



2200S-R/MT 022000533
(C22S-R+5902MT)



2300S-O/MT 023000561
(C23S-O+5902MT)



2300S-G/MT 023000562
(C23S-G+5902MT)



2300S-R/MT 023000563
(C23S-R+5902MT)



2300SC-O/MT 023000591
(C23SC O+5902MT)



2300SC-G/MT 023000592
(C23SC G+5902MT)



2300SC-R/MT 023000593
(C23SC R+5902MT)

5902MT/AS

Assortment of 99 tools for earth-moving machinery (CATERPILLAR)

Car repairs



Quantity/Description

Beta N.

2	drift punches 3 - 4 mm	30
2	pin punches 6 - 8 mm	31
1	centre punch 4 mm	32
2	flat chisels, ribbed type 150 - 200 mm	35
20	combination wrenches 1/4-1.1/2"	42AS
6	offset ring wrenches 1/4x5/16 - 3/8x7/16 - 1/2x9/16 5/8x3/4 - 11/16x13/16 - 7/8x15/16"	90AS
11	offset hexagon key wrenches 3/64"-3/8"	96AS/B11
10	1/2" square drive bi-hex sockets 7/16 - 1/2 - 9/16 5/8 - 11/16 - 3/4 - 13/16 - 7/8 - 15/16 - 1"	920AS
1	1/2" drive extension bar, 125 mm	920/21
1	1/2" drive extension bar, 255 mm	920/22
1	1/2" drive universal joint	920/25
1	1/2" drive sliding T-handle	920/42
1	1/2" drive push-through square ratchet	920/50
12	3/4" square drive hexagon sockets 7/8 - 15/16 - 1 - 1.1/16 - 1.1/8 - 1.1/4 - 1.5/16 1.1/2 - 1.5/8 - 1.11/16 - 1.7/8 - 2"	928AS
1	3/4" drive extension bar, 200 mm	928/21
1	3/4" drive swivel handle	928/36A
1	3/4" drive sliding T-handle	928/42
1	3/4" drive reversible ratchet	928/55
1	pry bar	964
1	slip joint pliers 240 mm	1048
1	adjustable self locking pliers, curved jaws	1055
1	heavy duty diagonal cutting nippers 160 mm	1084BM
1	electrician's scissors, straight blades	1128BMX
1	combination pliers 180 mm	1150BM
1	half-round needle nose pliers 160 mm	1166BM
4	screwdrivers for slotted head screws with hexagon bolsters 5.5x125 - 6.5x150 - 10x175 - 12x200 mm	1260E
3	screwdrivers for cross head Phillips® screws with hexagon bolsters PH2x150 - PH3x175 - PH4x200 mm	1262E
1	ball pein hammer 900 g	1377
1	soft face hammer Ø 35 mm	1390
1	feeler gauge, 20 blades	1708AS/20
1	three cutting edges scraper 200 mm	1717B
5	second cut files 200 mm	1719BMA/S5
1	hacksaw frame	1725

5902MT/AS

059020034



2200S-O/MTAS
(C22S-O+5902MT/AS)

022000541



2200S-G/MTAS
(C22S-G+5902MT/AS)

022000542



2200S-R/MTAS
(C22S-R+5902MT/AS)

022000543



2300S-OMT/AS
(C23S-O+5902MT/AS)

023000571



2300S-G/MTAS
(C23S-G+5902MT/AS)

023000572



2300S-R/MTAS
(C23S-R+5902MT/AS)

023000573

5904VG/1T

Assortment of 90 tools

Car repairs



Quantity/Description

Quantity/Description	Beta N.
2 flat chisels, ribbed type, 100 - 200 mm	35
21 combination wrenches, 6+22 - 24 - 27 - 30 - 32 mm	42
9 offset hexagon key wrenches, 1.5 - 2 - 2.5 - 3 - 4 - 5 - 6 - 8 - 10 mm	96/SP9
19 1/2" square drive hexagon sockets, 10+24 - 26 - 27 - 30 - 32 mm	920A
5 1/2" drive socket drivers for hexagon screws, 5 - 6 - 8 - 10 - 12 mm	920ME
1 1/2" wobble extension bar - 125 mm	920AN/125
1 1/2" wobble extension bar - 250 mm	920AN/250
1 1/2" drive universal joint	920/25
1 1/2" drive sliding T handle	920/42
1 1/2" drive reversible ratchet	920/55
1 internal circlip pliers, straight pattern, 180 mm	1032
1 internal circlip pliers, bent pattern, 170 mm	1034
1 external circlip pliers, straight pattern, 175 mm	1036
1 external circlip pliers, bent pattern, 175 mm	1038
1 slip joint pliers, boxed joints, 240 mm	1048
1 adjustable self-locking pliers, 240 mm	1052
1 heavy duty diagonal cutting nippers, 160 mm	1084BM
1 combination pliers, 180 mm	1150BM
1 straight nose pliers, 160 mm	1166BM
7 screwdrivers for slotted head screws, 2.5x50 - 3x75 - 3.5x100 - 4x125 5.5x100 - 5.5x150 - 6.5x150 mm	1290
6 screwdrivers for cross head Phillips® screws, PH0x60 - PH0x100 - PH1x80 PH1x120 - PH2x100 - PH2x150 mm	1292
1 engineer's hammer, 300 g	1370
1 soft face hammer, Ø 35 mm	1390
5 second cut files, 200 mm	1719BMA/55

5904VG/1T 059040154



2300ST-O/VG1T 023000631
(C23ST O+5904VG/1T)



2300ST-G/VG1T 023000632
(C23ST G+5904VG/1T)



2300ST-R/VG1T 023000633
(C23ST R+5904VG/1T)



2400S7-O/VG1T 024002721
(C24S7/O+5904VG/1T)



2400S7-G/VG1T 024002722
(C24S7/G+5904VG/1T)



2400S7-R/VG1T 024002723
(C24S7/R+5904VG/1T)



3600 O-7/VG1T 036000231
(C36 O/7+5904VG/1T)



3600 G-7/VG1T 036000232
(C36 G/7+5904VG/1T)



3600 R-7/VG1T 036000233
(C36 R/7+5904VG/1T)



3900 O-7/VG1T 039000141
(C39 O/7+5904VG/1T)



3900 G-7/VG1T 039000142
(C39 G/7+5904VG/1T)



3900 R-7/VG1T 039000143
(C39 R/7+5904VG/1T)

5904VG/2T

Assortment of 99 tools

Car repairs



Quantity/Description

Beta N.

- 2 flat chisels, ribbed type 100 - 200 mm 35
- 21 combination wrenches 6-22 - 24 - 27 - 30 - 32 mm 42
- 8 double open end wrenches 6x7 - 8x9 - 10x11 - 12x13 - 14x15 - 16x17 - 18x19 - 20x22 mm 55
- 9 offset hexagon key wrenches 1.5 - 2 - 2.5 - 3 - 4 - 5 - 6 - 8 - 10 mm 96/SP9
- 6 offset hexagon key wrenches with handle 2 - 2.5 - 3 - 4 - 5 - 6 mm 96T
- 6 offset key wrenches for Torx® head screws 97TTX
- T10 - T15 - T20 - T25 - T27 - T30
- 19 1/2" square drive hexagon sockets 10-24 - 26 - 27 - 30 - 32 mm 920A
- 5 1/2" drive socket drivers for hexagon screws 5 - 6 - 8 - 10 - 12 mm 920ME
- 1 1/2" drive extension bar, 125 mm 920/21
- 1 1/2" drive extension bar, 255 mm 920/22
- 1 1/2" drive universal joint 920/25
- 1 1/2" drive sliding T-handle 920/42
- 1 1/2" drive reversible ratchet 920/55
- 1 circlip pliers straight, internal 180 mm 1032
- 1 circlip pliers bent, internal 170 mm 1034
- 1 circlip pliers straight, external 175 mm 1036
- 1 circlip pliers bent, external 175 mm 1038
- 1 slip joint pliers 240 mm 1048
- 1 adjustable self locking pliers 240 mm 1052
- 1 heavy duty diagonal cutting nippers 160 mm 1084
- 1 combination pliers 180 mm 1150
- 1 needle nose pliers 160 mm 1166
- 4 screwdrivers for slotted head screws 3x75 - 4x100 - 5.5x150 - 6.5x150 mm 1260
- 3 screwdrivers for cross head Phillips® screws PH0x60 - PH1x80 - PH2x100 mm 1262
- 1 engineer's hammer 300 g 1370
- 1 soft face hammer Ø 35 mm 1390

5904VG/2T 059040151



2400S5-O/VG2T 024002511
(C24S5/O+5904VG/2T)



2400S5-G/VG2T 024002512
(C24S5/G+5904VG/2T)



2400S5-R/VG2T 024002513
(C24S5/R+5904VG/2T)



2400S6-O/VG2T 024002621
(C24S6/O+5904VG/2T)



2400S6-G/VG2T 024002622
(C24S6/G+5904VG/2T)



2400S6-R/VG2T 024002623
(C24S6/R+5904VG/2T)



3600 O-5/VG2T 036000211
(C36 O/5+5904VG/2T)



3600 G-5/VG2T 036000212
(C36 G/5+5904VG/2T)



3600 R-5/VG2T 036000213
(C36 R/5+5904VG/2T)



3900 O-6/VG2T 039000121
(C39 O/6+5904VG/2T)



3900 G-6/VG2T 039000122
(C39 G/6+5904VG/2T)



3900 R-6/VG2T 039000123
(C39 R/6+5904VG/2T)

5904VG/3

Assortment of 132 tools

Car repairs



Quantity/Description

Beta N.

- 6 pin punches 2 - 3 - 4 - 5 - 6 - 8 mm 31/B6
- 1 centre punch 5 mm 32
- 1 flat chisel, ribbed type 200 mm 35
- 17 combination wrenches 6-22 mm 42
- 8 double open end wrenches 6x7 - 8x9 - 10x11 - 12x13 - 14x15 - 16x17 - 18x19 - 20x22 mm 55
- 9 offset hexagon key wrenches 1.5 - 2 - 2.5 - 3 - 4 - 5 - 6 - 8 - 10 mm 96N/SP9
- 11 offset hexagon key wrenches 2-10 mm 96T/SP11
- 13 offset key wrenches for Torx® head screws T6-T50 97TX/B13
- 1 adjustable wrench with scale 300 mm 111
- 13 1/2" square drive hexagon sockets with rail, 10-22 mm 920A/SB13
- 1 1/2" drive extension bar, 125 mm 920/21
- 1 1/2" drive extension bar, 255 mm 920/22
- 1 1/2" drive universal joint 920/25
- 1 1/2" drive sliding T-handle 920/42
- 1 1/2" drive push-through square ratchet 920/50
- 6 T-handle wrenches with swivelling socket 8 - 10 - 12 - 13 - 17 - 19 mm 952
- 1 pry bar with handle 400 mm 965
- 2 circlip pliers straight, internal 180 - 225 mm 1032
- 2 circlip pliers bent, internal 170 - 210 mm 1034
- 2 circlip pliers straight, external 175 - 225 mm 1036
- 2 circlip pliers bent, external 175 - 220 mm 1038
- 1 slip joint pliers 240 mm 1048
- 1 self-locking pliers with adjustable force, 240 mm 1057
- 1 heavy duty diagonal cutting nippers 200 mm 1084BM
- 1 toggle lever assisted end cutting nippers 200 mm 1092V
- 1 tin snips 250 mm 1112
- 1 electrician's scissors, straight blades 1128BMX
- 1 combination pliers 180 mm 1150BM
- 4 screwdrivers for slotted head screws, 3x75 - 4x100 - 5.5x125 - 6.5x150 mm 1260
- 1 screwdriver for slotted head screws, extra-short series, 6.5x30 mm 1260N
- 2 screwdrivers for slotted head screws with hexagon bolsters 8x175 - 10x175 mm 1260E
- 3 screwdrivers for cross head Phillips® screws, PH0x100 - PH1x120 - PH2x100 mm 1262
- 1 screwdriver for cross head Phillips® screws, extra-short series, PH2x30 mm 1262N
- 1 screwdriver for cross head Phillips® screws with hexagon bolster PH3x175mm 1262E
- 1 screwdriver for cross head Phillips® screws, long series, PH2x400 mm 1262L
- 1 screwdriver for slotted headless screws, long series, 6.5x400 mm 1264L
- 1 engineer's hammer 500 g 1370
- 1 soft face hammer Ø 45 mm 1390
- 1 adjustable oil filter wrench 1491
- 1 precision feeler gauges, 20 blades 1708/20
- 5 second cut files 200 mm 1719BMA/S5
- 1 hacksaw frame, aluminium handle 1726BM
- 1 metal oil can 200 cc 1751

5904VG/3 059040152



2400S5-O/VG3 024002521
(C24S5/O+5904VG/3)



2400S5-G/VG3 024002522
(C24S5/G+5904VG/3)



2400S5-R/VG3 024002523
(C24S5/R+5904VG/3)



2400S6-O/VG3 024002631
(C24S6/O+5904VG/3)



2400S6-G/VG3 024002632
(C24S6/G+5904VG/3)



2400S6-R/VG3 024002633
(C24S6/R+5904VG/3)



2400S7-O/VG3 024002731
(C24S7/O+5904VG/3)



2400S7-G/VG3 024002732
(C24S7/G+5904VG/3)



2400S7-R/VG3 024002733
(C24S7/R+5904VG/3)



2400S8-O/VG3 024002811
(C24S8/O+5904VG/3)



2400S8-G/VG3 024002812
(C24S8/G+5904VG/3)



2400S8-R/VG3 024002813
(C24S8/R+5904VG/3)



2400SL-O/VG3 024002411
(C24SL/O+5904VG/3)



2400SL-G/VG3 024002412
(C24SL/G+5904VG/3)



2400SL-R/VG3 024002413
(C24SL/R+5904VG/3)

5904VG/4T

Assortment of 135 tools

Car repairs



Quantity/Description

Beta N.

2	flat chisels, ribbed type 100 - 200 mm	35
21	combination wrenches 6-22 - 24 - 27 - 30 - 32 mm	42
6	offset hexagon key wrenches with handle 2 - 2.5 - 3 - 4 - 5 - 6 mm	96T
6	bits for Torx® head screws T6-T15	861TX
8	bits for Torx® head screws T20-T55	866TX
1	socket holder 1/4x1/4"	895/1
1	socket holder 5/16x1/2"	895/6
6	1/4" sockets for Torx® head screws E4-E10	900FTX
19	1/2" square drive hexagon sockets 10-24 - 26 - 27 - 30 - 32 mm	920A
7	1/2" sockets for Torx® head screws E12-E24	920FTX
5	1/2" drive, socket drivers for hexagon screws 5 - 6 - 8 - 10 - 12 mm	920ME
3	1/2" drive, socket drivers for Torx® head screws T55L - T60 - T70L	920TX
1	1/2" drive extension bar, 125 mm	920/21
1	1/2" drive extension bar, 255 mm	920/22
1	1/2" drive universal joint	920/25
1	1/2" drive sliding T-handle	920/42
1	1/2" drive reversible ratchet	920/55
8	T-handle wrenches with swivelling socket 7 - 8 - 10 - 12 - 13 - 14 - 17 - 19 mm	952
2	spark plug sockets, 3/8" drive 16 - 20.8 mm	956E
2	spark plug sockets, 1/2" drive 16 - 20.8 mm	956L
2	T-handle swivel spark plug wrenches 16 - 20.8 mm	959
1	circclip pliers straight, internal 180 mm	1032
1	circclip pliers bent, internal 170 mm	1034
1	circclip pliers straight, external 175 mm	1036
1	circclip pliers bent, external 175 mm	1038
1	slip joint pliers 240 mm	1048
1	adjustable self locking pliers 240 mm	1052
1	heavy duty diagonal cutting nippers 160 mm	1084BM
1	combination pliers 180 mm	1150BM
1	half-round needle nose pliers 160 mm	1166BM
7	screwdrivers for slotted head screws 2.5x50 - 3x75 - 3.5x100 - 4x125 5.5x100 - 5.5x150 - 6.5x150 mm	1260
6	screwdrivers for cross head Phillips® screws PH0x60 - PH0x100 - PH1x80 - PH1x120 PH2x100 - PH2x150 mm	1262
2	screwdrivers for cross head Phillips® screws, long series, PH1x400 - PH2x400 mm	1262L
3	screwdrivers for headless slotted screws, long series, 3x300 - 4x400 - 5x400 mm	1264L
1	engineer's hammer 300 g	1370
1	soft face hammer Ø 35 mm	1390
1	spark-plug pliers 200 mm	1474
1	feeler gauges, 20 blades	1708/20
1	empty thermoformed tray	VP5

5904VG/4T 059040153



2400SL-O/VG4T 024002421
(C24SL/O+5904VG/4T)



2400SL-G/VG4T 024002422
(C24SL/G+5904VG/4T)



2400SL-R/VG4T 024002423
(C24SL/R+5904VG/4T)



3600 O-7/VG4T 036000241
(C36 O/7+5904VG/4T)



3600 G-7/VG4T 036000242
(C36 G/7+5904VG/4T)



3600 R-7/VG4T 036000243
(C36 R/7+5904VG/4T)



3900 O-7/VG4T 039000161
(C39 O/7+5904VG/4T)



3900 G-7/VG4T 039000162
(C39 G/7+5904VG/4T)



3900 R-7/VG4T 039000163
(C39 R/7+5904VG/4T)

5904VG/5T

Assortment of 160 tools

Car repairs



5904VG/5T 059040160



2400S8-O/VG5T 024002821
(C24S8/O+5904VG/5T)



2400S8-G/VG5T 024002822
(C24S8/G+5904VG/5T)



2400S8-R/VG5T 024002823
(C24S8/R+5904VG/5T)



3900 O-8/VG5T 039000181
(C39 O/8+5904VG/5T)



3900 G-8/VG5T 039000182
(C39 G/8+5904VG/5T)



3900 R-8/VG5T 039000183
(C39 R/8+5904VG/5T)

Quantity/Description

Quantity/Description	Beta N.
2 flat chisels, ribbed type 100 - 200 mm	35
21 combination wrenches 6+22 - 24 - 27 - 30 - 32 mm	42
8 double open end wrenches 6x7 - 8x9 - 10x11 - 12x13 - 14x15 - 16x17 - 18x19 - 20x22	55
9 offset hexagon key wrenches 1.5 - 2 - 2.5 - 3 - 4 - 5 - 6 - 8 - 10 mm	96/SP9
6 offset hexagon key wrenches with handles 2 - 2.5 - 3 - 4 - 5 - 6 mm	96T
6 bits for Torx® head screws T6+T15	861TX
8 bits for Torx® head screws T20+T55	866TX
1 socket holder 1/4x1/4"	895/1
1 socket holder 5/16x1/2"	895/6
6 1/4" drive sockets for Torx® head screws E4+E10	900FTX
19 1/2" square drive hexagon sockets, 10+24 - 26 - 27 - 30 - 32 mm	920A
7 1/2" drive sockets for Torx® head screws E12+E24	920FTX
5 1/2" drive socket drivers for hexagon screws 5 - 6 - 8 - 10 - 12 mm	920ME
3 1/2" drive socket drivers for Torx® head screws T55L - T60 - T70L	920TX
1 extension bar 125 mm - 1/2"	920/21
1 extension bar 255 mm - 1/2"	920/22
1 1/2" drive universal joint	920/25
1 1/2" drive sliding T handle	920/42
1 1/2" drive reversible ratchet	920/55
8 T-handle wrenches with swivelling hexagon sockets 7 - 8 - 10 - 12 - 13 - 14 - 17 - 19 mm	952
1 internal circlip pliers, straight pattern 180 mm	1032
1 internal circlip pliers, bent pattern 170 mm	1034
1 external circlip pliers, straight pattern 175 mm	1036
1 external circlip pliers, bent pattern 175 mm	1038
1 slip joint pliers 240 mm	1048
1 adjustable self-locking pliers 240 mm	1052
1 heavy duty diagonal cutting nippers 160 mm	1084BM
1 combination pliers 180 mm	1150BM
1 half-round needle nose pliers 160 mm	1166BM
10 screwdrivers for slotted head screws 2.5x50 - 3x75 - 3.5x100 - 4x125 - 5.5x100 - 5.5x150 - 6.5x150 - 8x150 - 8x200 - 10x200 mm	1290
2 screwdrivers for slotted head screws, extra-short 4x30 - 6.5x30 mm	1290N
8 screwdrivers for cross head Phillips® screws PH0x60 - PH0x100 - PH1x80 - PH1x120 - PH2x100 - PH2x150 - PH3x150 - PH4x200 mm	1292
2 screwdrivers for cross head Phillips® screws PH1x30 - PH2x30 mm	1292N
12 driver for Torx® head screws, with handle T25 - T27 - T30 - T40 - T45	1297TX
1 engineer's hammer 300 g	1370S
1 soft face hammer Ø 35 mm	1390
1 thermoformed tray, empty	VP6

5905VG/0

assortment of 90 tools

Car repairs



14 kg

5905VG/0 059050061



2500/VG0 025000071
(C25+5905VG/0)

Quantity/Description

Quantity/Description	Beta N.
4 pin punches Ø 2 - 3 - 4 - 5 mm	31
1 centre punch Ø 4 mm	32
1 flat chisel 150 mm	34
12 combination wrenches 6 - 7 - 8 - 10 - 11 - 12 - 13 - 14 - 17 - 19 - 22 - 24 mm	42
9 ball head offset hexagon key wrenches 1.5 - 2 - 2.5 - 3 - 4 - 5 - 6 - 8 - 10 mm	96BPC/SP9
5 offset hexagon key wrenches, with high torque handles 3 - 4 - 5 - 6 - 8 mm	96T/S5
20 1/2" square drive hexagon sockets 10+24, 26 - 27 - 28 - 30 - 32	920A
1 1/2" drive extension bar 125 mm	920/21
1 1/2" drive extension bar 255 mm	920/22
1 1/2" drive universal joint	920/25
1 1/2" drive sliding T handle	920/42
1 1/2" drive reversible ratchet	920/55
8 T-handle wrenches with swivelling hexagon sockets 8 - 10 - 12 - 13 - 14 - 15 - 16 - 17 mm	952
1 spark plug socket 16 mm	956C
1 internal circlip pliers, straight pattern 180 mm	1032
1 external circlip pliers, straight pattern 175 mm	1036
1 slip joint pliers 240 mm	1048
1 heavy duty diagonal cutting nippers 160 mm	1084BM
1 combination pliers 180 mm	1150BM
1 half-round needle nose pliers 160 mm	1166BM
1 electrician's scissors, straight blades	1128BMX
1 screwdriver for Dzus® head screws	1201DZ
5 screwdrivers for slotted head screws 3x75 - 4x100 - 5.5x150 - 6.5x150 - 8x150 mm	1290/S5
4 screwdrivers for cross head Phillips® screws PH0x60 - PH1x80 - PH2x100 - PH3x150 mm	1292/S4
4 drivers for Torx® head screws with handles T15 - T20 - T30 - T40	1297TX
1 engineer's hammer 400 g	1370
1 soft face hammer Ø 35 mm	1390
1 strap wrench for oil filters	1490/1

5905VG/1

Assortment of 94 tools for car body repair shops

Car repairs



5905VG/1

059050057



2500/VG1

(C25+5905VG/1)

025000072

Quantity/Description

- 1 drift punch 4 mm
- 6 pin punches Ø 2 - 3 - 4 - 5 - 6 - 8 mm
- 1 centre punch 4 mm
- 1 flat chisel, standard type 150 mm
- 1 cape chisel, standard type 150 mm
- 17 combination wrenches 6-17 mm
- 10 offset hexagon key wrenches 1.5-12 mm
- 1 adjustable wrench with scale, 300 mm
- 12 hi-torque hexagon nut spinners, long series, 4+14 mm
- 1 pry bar with handle 400 mm
- 1 slip joint pliers 240 mm
- 1 adjustable self locking pliers 240 mm
- 1 adjustable self locking pliers, aluminium jaws 280 mm
- 1 heavy duty diagonal cutting nippers 160 mm
- 1 construction worker's pincers 250 mm
- 1 compound leverage shears, straight blades
- 1 electrician's scissors, straight blades
- 1 combination pliers 180 mm
- 1 screwdrivers for Dzus® head screws
- 4 screwdrivers for slotted head screws 3x75 - 4x100 - 5.5x150 - 6.5x150 mm
- 1 screwdriver for slotted head screws, extra-short series, 4x30 mm
- 2 screwdrivers for slotted head screws with hexagon bolsters 10x175 - 12x200 mm
- 3 screwdrivers for cross head Phillips® screws PH0x60 - PH1x80 - PH2x100 mm
- 1 screwdriver for cross head Phillips® screws, extra-short series, PH1x30 mm
- 1 screwdriver for cross head Phillips® screws with hexagon bolster PH3x175 mm
- 6 drivers for Torx® head screws T10 - T15 - T20 - T25 - T27 - T30
- 1 curved dolly 1350 g
- 1 toe dolly
- 1 heel dolly
- 1 general purpose dolly
- 1 buffer dolly
- 1 curved angle spoon
- 1 heavy duty spoon
- 1 long double-ended spoon
- 1 body blade holder, with blade 9°
- 1 extra flat chisel with hand guard
- 1 body hammer
- 1 body hammer Ø 32 mm
- 1 engineer's hammer 300 g
- 1 soft face hammer Ø 35 mm
- 1 measuring tape 5 m

Beta N.

- 30
- 31/B6
- 32
- 34
- 36
- 42/S17
- 96/B10
- 111N
- 943BX
- 965
- 1048
- 1052
- 1060AL
- 1084BM
- 1098PL
- 1122
- 1128BMX
- 1150BM
- 1201DZ
- 1260
- 1260N
- 1260E
- 1262
- 1262N
- 1262E
- 1267TX
- 1303
- 1305
- 1306
- 1310
- 1313
- 1326
- 1327
- 1330
- 1338A
- 1342PM
- 1345
- 1357Z/32
- 1370
- 1390
- 1691A/5

5905VG/2

Assortment of 118 tools

Car repairs



5905VG/2

059050043



2500/VG2

(C25+5905VG/2)

025000073

Quantity/Description

- 2 drift punches 3 - 4 mm
- 4 pin punches 2 - 3 - 4 - 5 mm
- 1 centre punches 4 mm
- 2 flat chisels, standard type 125 - 150 mm
- 2 cape chisels, standard type 125 - 150 mm
- 14 combination wrenches 5.5-14 - 17 - 19 - 22 - 24 mm
- 13 double open end wrenches 6x7 - 8x9 - 10x11 - 12x13 - 14x15 - 16x17 - 18x19 - 20x22 - 21x23 - 24x26 - 25x28 - 27x29 - 30x32 mm
- 3 half-moon ring wrenches 11x13 - 14x17 - 19x22 mm
- 10 offset hexagon key wrenches 1.5-12 mm
- 2 1/2" drive impact sockets 17 - 19 mm
- 20 1/2" drive hexagon sockets 10-24 - 26 - 27 - 28 - 30 - 32 mm
- 1 1/2" drive extension bar, 125 mm
- 1 1/2" drive extension bar, 255 mm
- 1 1/2" drive universal joint
- 1 1/2" drive sliding T-handle
- 1 1/2" drive reversible ratchet
- 8 T-handle wrenches with swivelling socket 7 - 8 - 10 - 11 - 13 - 14 - 17 - 19 mm
- 1 T-handle swivel spark plug wrench 20.8 mm
- 1 wheel nut wrench 17x19x22x n 1/2"
- 1 circlip pliers straight, internal 180 mm
- 1 circlip pliers bent, internal 170 mm
- 1 circlip pliers straight, external 175 mm
- 1 circlip pliers bent, external 175 mm
- 1 slip joint pliers 240 mm
- 1 adjustable self locking pliers 240 mm
- 1 heavy duty diagonal cutting nippers 160 mm
- 1 compound leverage shears, straight blades, 250 mm
- 1 electrician's scissors, straight blades
- 1 combination pliers 180 mm
- 1 half-round needle nose pliers 160 mm
- 8 screwdrivers for slotted head screws, 2.5x50 - 3x75 - 3.5x100 - 4x125 - 5.5x150 - 6.5x150 - 8x200 - 10x200 mm
- 2 screwdrivers for slotted head screws with hexagon bolsters 10x175 - 12x200 mm
- 1 screwdriver for slotted head screws, extra-short series, 6.5x30 mm
- 4 screwdrivers for cross head Phillips® screws PH0x60 - PH1x80 - PH2x100 - PH3x150 mm
- 1 engineer's hammer 400 g
- 1 soft face hammer Ø 35 mm
- 1 adjustable oil filter wrench
- 1 circuit tester 3/48 V

Beta N.

- 30
- 31
- 32
- 34
- 36
- 42
- 55
- 83
- 96/NB10
- 720
- 920A
- 920/21
- 920/22
- 920/25
- 920/42
- 920/55
- 952
- 959
- 979
- 1032
- 1034
- 1036
- 1038
- 1048
- 1052
- 1084BM
- 1122
- 1128BMX
- 1150BM
- 1166BM
- 1260
- 1260E
- 1260N
- 1262
- 1370
- 1390
- 1491
- 1498

5908VG/1

Assortment of 171 tools

Car repairs



5908VG/1 059080090



2800N O/VG1 028000331
(C28N O+5908VG/1)



2800N G/VG1 028000332
(C28N G+5908VG/1)



2800N R/VG1 028000333
(C28N R+5908VG/1)

Quantity/Description

Quantity/Description	Beta N.
6 pin punches 2 - 3 - 4 - 5 - 6 - 8 mm	31/B6
1 centre punch 5 mm	32
1 flat chisel, ribbed type 200 mm	35
21 combination wrenches 6-22 - 24 - 27 - 30 - 32 mm	42
13 double open end wrenches 6x7 - 8x9 - 10x11 - 12x13 - 14x15 - 16x17 - 18x19 - 20x22 - 21x23 - 24x26 - 25x28 - 27x29 - 30x32 mm	55
8 double ended offset ring wrenches 6x7 - 8x9 - 10x11 - 12x13 - 14x15 - 16x17 - 18x19 - 20x22 mm	90/S8
15 offset hexagon key wrenches 1.5 - 2 - 2.5 - 3 - 4 - 5 - 6 - 7 - 8 - 10 - 12 - 13 - 14 - 17 - 19 mm	96N
11 offset hexagon key wrenches 2-10 mm	96T/SP11
11 offset key wrenches for Torx® head screws T8-T50	97TTX/S11
1 adjustable wrench with scale, 300 mm	111
13 1/2" square drive hexagon sockets with rail, 10-22 mm	920A/SB13
8 1/2" square drive hexagon sockets with rail, 23-32 mm	920A/SB8
7 1/2" drive, socket drivers for hexagon screws 5 - 6 - 8 - 10 - 12 - 14 - 17 mm	920ME
1 1/2" drive extension bar, 125 mm	920/21
1 1/2" drive extension bar, 255 mm	920/22
1 1/2" drive universal joint	920/25
1 1/2" drive sliding T-handle	920/42
1 1/2" drive push-through square ratchet	920/55
6 T-handle wrenches with swivelling socket 8 - 10 - 12 - 13 - 17 - 19 mm	952
1 pry bar with handle 400 mm	965
2 circlip pliers straight, internal 180 - 225 mm	1032
2 circlip pliers bent, internal 170 - 210 mm	1034
2 circlip pliers straight, external 175 - 225 mm	1036
2 circlip pliers bent, external 175 - 220 mm	1038
1 slip joint pliers 240 mm	1048
1 adjustable self locking pliers 240 mm	1052
1 heavy duty diagonal cutting nippers 200 mm	1084BM
1 toggle lever assisted end cutting nippers 200 mm	1092V
1 tin snips 250 mm	1112
1 electrician's scissors, straight blades	1128BMX
1 combination pliers 180 mm	1150BM
4 screwdrivers for slotted head screws 3x75 - 4x100 - 6.5x150 - 8x150 mm	1260
1 screwdriver for slotted head screws, extra-short series, 6.5x30 mm	1260N
3 screwdrivers for slotted head screws with hexagon bolsters 6.5x150 - 10x175 - 12x200 mm	1260E
2 screwdrivers for cross head Phillips® screws PH0x100 - PH1x120 mm	1262
1 screwdriver for cross head Phillips® screws, extra-short series, PH2x30 mm	1262N
2 screwdrivers for cross head Phillips® screws with hexagon bolsters PH3x175 - PH4x200 mm	1262E
1 screwdriver for cross head Phillips® screws, long series, PH2x400 mm	1262L
1 screwdriver for headless slotted screws, long series, 6.5x400 mm	1264L
2 engineer's hammers 300 - 1000 g	1370
1 soft face hammer Ø 60 mm	1390
1 adjustable oil filter wrench	1491
1 feeler gauges, 20 blades	1708/20
1 flexible magnetic pick-up tool 0.5 kg	1712E/1
5 second cut files 200 mm	1719BMA/S5
1 hacksaw frame, aluminium handle	1726BM
1 metal oil can 200 cc	1751

Car repairs



5908VG/2

059080095



2800N O/VG2
(C28N O+5908VG/2)

028000341



2800N G/VG2
(C28N G+5908VG/2)

028000342



2800N R/VG2
(C28N R+5908VG/2)

028000343

Quantity/Description

Beta N.

6	pin punches 2 - 3 - 4 - 5 - 6 - 8 mm	31
1	centre punch 5 mm	32
2	flat chisel, ribbed type 100 - 200 mm	35
25	combination wrenches 6-22 - 24 - 27 - 30 - 32 - 35 - 36 - 38 - 41 mm	42
13	double open end wrenches 6x7 - 8x9 - 10x11 - 12x13 - 14x15 - 16x17 18x19 - 20x22 - 21x23 - 24x26 - 25x28 - 27x29 - 30x32 mm	55
15	double ended offset ring wrenches 6x7 - 8x9 - 10x11 - 12x13 - 14x15 - 16x17 18x19 - 20x22 - 21x23 - 24x26 - 25x28 - 27x29 - 30x32 - 35x38 - 36x41 mm	90
1	flare nut open ring wrench 17x19 mm	94
4	offset hexagon key wrenches 13 - 14 - 17 - 19 mm	96N
10	offset hexagon key wrenches 1.5-12 mm	96N/B10
13	offset key wrenches for Torx® head screws T6-T50	97TX/B13
1	adjustable wrench with scale, 300 mm	111
7	3/4" square drive impact sockets long, slim series 22 - 24 - 27 - 30 - 32 - 33 - 36 mm	728LS
13	1/2" square drive hexagon sockets with rail, 10-22 mm	920A/SB13
8	1/2" square drive hexagon sockets with rail, 23-32 mm	920A/SB8
7	1/2" drive, socket drivers with rail, 5-17 mm	920ME/SB7
1	adaptor, 1/2" female to 3/4" male drive	920/16
1	1/2" drive extension bar, 125 mm	920/21
1	1/2" drive extension bar, 255 mm	920/22
1	1/2" drive universal joint	920/25
1	1/2" drive sliding T-handle	920/42
1	1/2" drive push-through square ratchet	920/50
11	3/4" square drive hexagon sockets 22 - 24 - 27 - 30 - 32 - 36 - 41 - 46 - 50 - 55 - 60 mm	928A
1	3/4" drive extension bar 200 mm	928/21
1	3/4" drive extension bar 380 mm	928/22
1	3/4" drive sliding T-handle	928/42
1	3/4" drive reversible ratchet	928/55
7	T-handle wrenches with swivelling sockets 8 - 10 - 12 - 13 - 14 - 17 - 19 mm	952
1	pry bar with handle 600 mm	965
3	circip pliers straight, internal 180 - 225 - 300 mm	1032
3	circip pliers bent, internal 170 - 210 - 290 mm	1034
3	circip pliers straight, external 175 - 225 - 300 mm	1036
3	circip pliers bent, external 175 - 220 - 300 mm	1038
2	slip joint pliers 240 - 300 mm	1048
1	adjustable self locking pliers 255 mm	1051
1	heavy duty diagonal cutting nippers 200 mm	1084BM
1	toggle lever assisted end cutting nippers 200 mm	1092V
1	tin snips 250 mm	1112
1	electrician's scissors, straight blades	1128BMX
1	combination pliers 180 mm	1150BM
3	screwdrivers for slotted head screws 3x75 - 4x100 - 8x200 mm	1260
1	screwdriver for slotted head screws, extra-short series, 6.5x30	1260N
4	screwdrivers for slotted head screws with hexagon bolsters 5.5x125 - 6.5x150 - 10x175 - 12x200 mm	1260E
2	screwdrivers for cross head Phillips® screws PH0x100 - PH1x120 mm	1262
1	screwdriver for cross head Phillips® screws, extra-short series, PH2x30 mm	1262N
3	screwdrivers for cross head Phillips® screws with hexagon bolsters PH2x150 - PH3x175 - PH4x200 mm	1262E
1	screwdriver for cross head Phillips® screws, long series, PH2x400 mm	1262L
1	screwdriver for slotted headless screws, long series, 6.5x400 mm	1264L
2	engineer's hammers 500 - 2000 g	1370
1	dead blow hammer Ø 50 mm	1392
1	adjustable oil filter wrench	1491
1	feeler gauge, 20 blades	1708/20
1	flexible magnetic pick-up tool 1.8 kg	1712E/2
1	articulated inspection mirror	1715
1	three-cutting edges scraper 200 mm	1717B
5	second cut files 200 mm	1719BMA/S5
1	hacksaw frame, aluminium handle	1726BM
1	brake shoe cleaning brush	1737NX
1	metal oil can, flexible spout 200 cc	1751
1	snap-off blade utility knife	1771BM

5910VG/3

Assortment of 316 tools

Car repairs

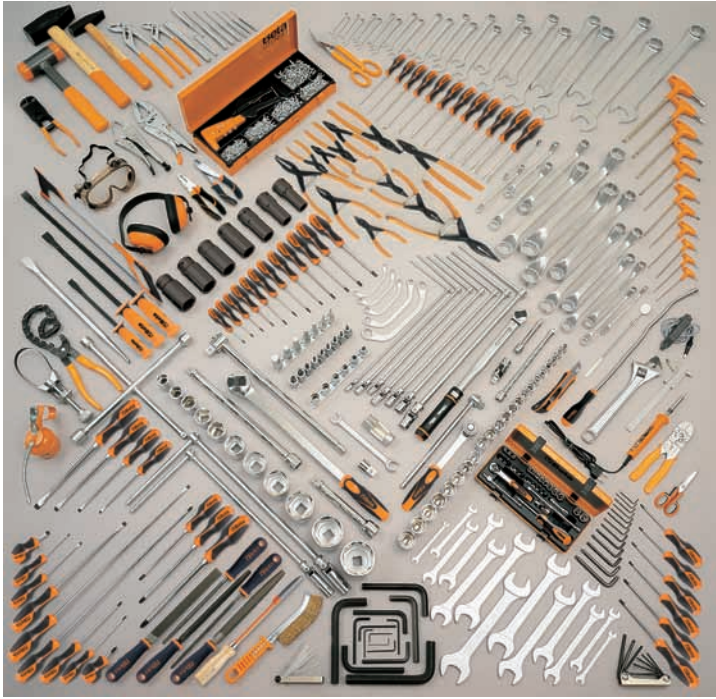

5910VG/3

059100046



3000/VG3
(C30+5910VG/3)

030000084

Quantity/Description

Quantity/Description	Beta N.
6 pin punches 2 - 3 - 4 - 5 - 6 - 8 mm	31
1 centre punch 5 mm	32
2 flat chisels, ribbed type 100 - 200 mm	35
8 combination wrenches 24 - 27 - 30 - 32 - 35 - 36 - 38 - 41 mm	42
17 combination wrenches 6-22 mm	42/S17
13 double open end wrenches 6x7 - 8x9 - 10x11 - 12x13 - 14x15 - 16x17 - 18x19 - 20x22 - 21x23 - 24x26 - 25x28 - 27x29 - 30x32 mm	55/S13
5 half-moon ring wrenches 8x10 - 10x12 - 11x13 - 14x17 - 19x22 mm	83
2 offset ring wrenches 35x38 - 36x41 mm	90
13 double ended offset ring wrenches 6x7-30x32 mm	90/S13
1 flare nut open ring wrench 17x19 mm	94
4 offset hexagon key wrenches 13 - 14 - 17 - 19 mm	96N
10 offset hexagon key wrenches 1.5 - 2 - 2.5 - 3 - 4 - 5 - 6 - 8 - 10 - 12 mm	96N/B10
11 offset hexagon key wrenches 2-10 mm	96T/SP11
13 offset key wrenches for Torx® head screws T6-T50	97TX/B13
1 adjustable wrench with scale, 300 mm	111
1 1/2" click type torque wrench 40-200Nm	606/20
7 3/4" square drive impact sockets, long slim series 22-36 mm	728LS
30 1/2" drive, 13 hexagon sockets, 11 socket drivers and 6 accessories	900/C24
13 1/2" square drive hexagon sockets with rail, 10-22 mm	920A/SB13
8 1/2" square drive hexagon sockets with rail, 23-32 mm	920A/SB8
6 1/2" sockets for Torx® head screws E10-E20	920FTX/SB6
7 1/2 square drive, socket drivers with rail, 5-17 mm	920ME/SB7
9 1/2" drive, socket drivers for Torx® head screws T20-T60	920TX/SB9
1 adaptor, 1/2" female to 3/4" male drive	920/16
1 1/2" drive extension bar, 125 mm	920/21
1 1/2" drive extension bar, 255 mm	920/22
1 1/2" drive universal joint	920/25
1 1/2" drive sliding T-handle	920/42
1 1/2" drive push-through square ratchet	920/50
11 3/4" square drive hexagon sockets 22 - 24 - 27 - 30 - 32 - 36 - 41 - 46 - 50 - 55 - 60 mm	928A
1 3/4" drive extension bar, 200 mm	928/21
1 3/4" drive extension bar, 380 mm	928/22
1 3/4" drive sliding T-handle	928/42
1 3/4" drive reversible ratchet	928/55
12 socket wrenches with handle, long series 4-14 mm	943BM/S12
7 T-handle wrenches with swivelling socket 8 - 10 - 12 - 13 - 14 - 17 - 19 mm	952
2 T-handle swivel spark plug wrenches 16 - 20.8 mm	959
1 1/2" socket wrench for Lambda probe 22xL 85 mm	960SL
1 pry bar	963
3 pry bars with handle 300 - 400 - 600 mm	965
1 wheel nut wrench 17x19x22x n 1/2"	979
3 circlip pliers straight, internal 180 - 225 - 300 mm	1032
3 circlip pliers bent, internal 170 - 210 - 290 mm	1034
3 circlip pliers straight, external 175 - 225 - 300 mm	1036
3 circlip pliers bent, external 175 - 220 - 300 mm	1038
2 slip joint pliers 240 - 300 mm	1048
1 self locking pliers, double adjustment	1051
1 adjustable self locking pliers 240 mm	1052
1 heavy duty diagonal cutting nippers 200 mm	1084BM
1 toggle lever assisted end cutting nippers 200 mm	1092V
1 tin snips 250 mm	1112
1 electrician's scissors, straight blades	1128BMX
1 combination pliers 180 mm	1150BM
3 screwdrivers for slotted head screws 3x75 - 4x100 - 8x200 mm	1260
1 screwdriver for slotted head screws, extra-short series, 6.5x30 mm	1260N
4 screwdrivers for slotted head screws with hexagon bolsters 5.5x125 - 6.5x150 - 10x175 - 12x200 mm	1260E
2 screwdrivers for cross head Phillips® screws, PH0x100 - PH1x120 mm	1262
1 screwdriver for cross head Phillips® screws, extra-short series, PH2x30 mm	1262N
3 screwdrivers for cross head Phillips® screws with hexagon bolsters PH2x150 - PH3x175 - PH4x200 mm	1262E
1 screwdriver for cross head Phillips® screws, long series, PH2x400 mm	1262L
1 screwdriver for headless slotted screws, long series, 6.5x400 mm	1264L
13 drivers for Torx® head screws, T5+T45	1267TX/S13
7 screwdrivers for Tamper Resistant Torx® head screws, T9+T30	1268RTX/S7
2 engineer's hammers 500 - 2000 g	1370
1 dead blow hammer Ø 50 mm	1392
1 pliers for exhaust pipe cutting	1476A
1 adjustable oil filter wrench	1491
1 circuit tester 3-48 V	1498
1 crimping pliers for non insulated closed terminals	1603A
1 mono-block workshop vernier	1650
1 precision feeler gauges, 20 blades	1708/20
1 flexible magnetic pick-up tool 1.8 kg	1712E/2
1 articulated inspection mirror	1715
1 three cutting edges scraper 200 mm	1717B
5 second cut files 200 mm	1719BMA/S5
1 hacksaw frame	1726BM
1 brake shoe cleaning brush	1737NX
1 riveting pliers with assortment of 700 rivets	1741B/C5
1 metal oil can 200 cc	1751
1 snap-off blade cutter	1771BM
1 soldering iron 20-40 W	1816A
1 safety goggles	1918
1 ear protectors	1918C

5940M2

Assortment of 139 tools for motorcycle repairs

Motorcycle repairs



5940M2

059400051



4100S/M2
(C41S+5940/M2)

041000082

4100H/M2
(C41H+5940/M2)

041000092

Quantity/Description

- 2 drift punches, Ø 2 - 3 mm
- 1 centre punch, Ø 4 mm
- 2 flat chisels, 125 - 150 mm
- 1 cape chisel, 150 mm
- 9 combination wrenches, 6 - 7 - 8 - 10 - 11 - 13 - 14 - 17 - 19 mm
- 1 combination wrench, 12 mm
- 6 double open end wrenches, 6x7 - 8x9 - 10x11 - 12x13 - 14x15 - 16x17 mm
- 9 offset hexagon key wrenches, 1.5 - 2 - 2.5 - 3 - 4 - 5 - 6 - 8 - 10 mm
- 1 3/8" click-type torque wrench, 8+60 Nm
- 54 assortment of 52 hexagon bits, 10 mm, and 2 accessories
- 1 adaptor, 1/2" female and 3/8" male drives
- 1 3/8" drive universal joint
- 17 assortment of 12 sockets and 5 accessories
- 3 3/8" drive universal joint
- 2 3/8" square drive spark plug sockets, 16 - 17.8 mm
- 1 extra-long nose pliers, 283 mm
- 2 internal circlip pliers, straight pattern, 140 - 180 mm
- 1 external circlip pliers, straight pattern, 140x1.3 mm
- 1 self-locking pliers, 235 mm
- 1 heavy duty diagonal cutting nippers, 160 mm
- 1 combination pliers, 180 mm
- 1 screwdriver for Dzus® head screws
- 4 screwdrivers for slotted head screws, 3x75 - 4x100 - 5.5x100 - 6.5x150 mm
- 3 screwdrivers for cross head Phillips® screws, PH0x60 - PH1x80 - PH2x100 mm
- 1 circuit testing screwdriver
- 1 engineer's hammer, 500 g
- 1 Clic® collar pliers
- 1 plastic hose pliers
- 1 adjustable oil filter wrench
- 1 metric feeler gauge, 13 blades
- 3 needle files
- 1 mini-hacksaw frame
- 1 brush, brass wires
- 1 plastic pressure oil can, 250 cc
- 1 utility knife

Beta N.

- 30
- 32
- 34
- 36
- 42/B9
- 42
- 55/B6
- 96/SP9
- 606/6
- 867/C52
- 910/16
- 910/25
- 920A/C12X
- 952
- 956E
- 1009L/A
- 1032
- 1036
- 1054
- 1084
- 1150
- 1201DZ
- 1201
- 1202
- 1254
- 1370
- 1472FS
- 1481PL/A-B
- 1491
- 1708/13
- 1720/S3
- 1725SR
- 1737
- 1754
- 1770A

5953VG

Assortment of 147 tools

Car repairs



5953VG

059530080



5300VG
(C53VG+5953VG)

053000021

Quantity/Description

- 5 pin punches 2 - 3 - 4 - 5 - 6 mm
- 1 centre punch 4 mm
- 1 flat chisel, standard type 150 mm
- 18 combination wrenches 6-14 - 16 - 17 - 18 - 19 - 21 - 22 - 24 - 27 - 30 mm
- 12 double open end wrenches 6x7 - 8x9 - 10x11 - 12x13 - 14x15 - 16x17 - 18x19 - 20x22 - 21x23 - 24x26 - 27x29 - 30x32 mm
- 3 half-moon ring wrenches 11x13 - 14x17 - 19x22 mm
- 12 offset hexagon key wrenches 2-10 mm
- 11 offset hexagon key wrenches with handle 2-8 - 10 mm
- 20 1/2" square drive hexagon sockets 10-24 - 26 - 27 - 28 - 30 - 32 mm
- 5 1/2" socket drivers for hexagon screws 5 - 6 - 8 - 10 - 12 mm
- 1 1/2" drive extension bar, 125 mm
- 1 1/2" drive extension bar, 255 mm
- 1 1/2" drive universal joint
- 1 1/2" drive sliding T-handle
- 1 1/2" drive reversible ratchet
- 10 T-handle wrenches with swivelling socket 6 - 7 - 8 - 10 - 11 - 12 - 13 - 14 - 17 - 19 mm
- 2 T-handle swivel spark plug wrenches 16 - 20.8 mm
- 1 wheel nut wrench 17x19x22x n 1/2"
- 1 circlip pliers straight, internal 140 - 180 mm
- 1 circlip pliers bent, internal 170 mm
- 1 circlip pliers straight, external 140x1.3 - 175 mm
- 1 circlip pliers bent, external 175 mm
- 1 slip joint pliers 240 mm
- 1 adjustable self locking pliers 240 mm
- 1 heavy duty diagonal cutting nippers 160 mm
- 1 tin snips 250 mm
- 1 electrician's scissors, straight blades
- 1 combination pliers 180 mm
- 5 screwdrivers for slotted head screws 3x75 - 4x100 - 5.5x100 - 6.5x150 - 10x200 mm
- 2 screwdrivers for slotted head screws, extra-short series, 4x30 - 6.5x30 mm
- 4 screwdrivers for cross head Phillips® screws PH0x60 - PH1x80 - PH2x100 - PH3x150 mm
- 2 screwdrivers for cross head Phillips® screws, extra-short series, PH1x30 - PH2x30 mm
- 1 screwdriver for cross head Phillips® screws, long series, PH2x400 mm
- 1 screwdriver for headless slotted screws, long series, 6.5x400 mm
- 1 engineer's hammer 400 g
- 1 soft face hammer Ø 35 mm
- 1 circlip pliers for butt-ended circlips
- 1 adjustable oil filter wrench
- 1 crimping pliers for non insulated terminals
- 1 precision feeler gauge, 13 blades
- 1 flexible magnetic pick-up tool 0.5 kg
- 5 second cut files 200 mm
- 1 hacksaw frame, aluminium handle
- 1 plastic oil can, flexible spout 250 cc

Beta N.

- 31
- 32
- 34
- 42
- 55
- 83
- 96
- 96T
- 920A
- 920ME
- 920/21
- 920/22
- 920/25
- 920/42
- 920/55
- 952
- 959
- 979
- 1032
- 1034
- 1036
- 1038
- 1048
- 1052
- 1084BM
- 1112
- 1128BMX
- 1150BM
- 1260
- 1260N
- 1262
- 1262N
- 1262L
- 1264L
- 1370
- 1390
- 1458
- 1491
- 1603
- 1708/13
- 1712E/1
- 1719BMA/S5
- 1726BM
- 1754

Car repairs

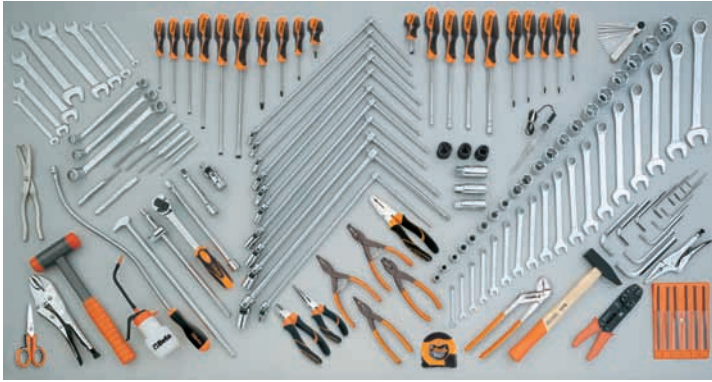

5954VG  059540080



5400 O/VG (C54VG O+5954VG) 054000180



5400 G/VG (C54VG G+5954VG) 054000182



5400 R/VG (C54VG R+5954VG) 054000184

Quantity/Description

Beta N.

5	pin punches 2 - 3 - 4 - 5 - 6 mm	31
1	centre punch 4 mm	32
1	flat chisel, standard type 125 mm	34
18	combination wrenches 6-22 - 24 mm	42
8	double open end wrenches 6x7 - 8x9 - 10x11 - 12x13 - 14x15 - 16x17 - 18x19 - 20x22 mm	55
3	offset ring wrenches 12x13 - 14x15 - 17x19 mm	90
13	offset hexagon key wrenches 2-10 - 12 mm	96
3	1/2" square drive impact sockets 17 - 19 - 22 mm	720
1	3/8" drive swivel T-handle	910/40
20	1/2" socket drive hexagon sockets 10-24 - 26 - 27 - 28 - 30 - 32 mm	920A
1	1/2" drive extension bar, 125 mm	920/21
1	1/2" drive extension bar, 255 mm	920/22
1	1/2" drive universal joint	920/25
1	1/2" drive sliding T-handle	920/42
1	1/2" drive reversible ratchet	920/55
4	nut spinners, long series 6 - 7 - 8 - 10 mm	943BM
10	T-handle wrenches with swivelling socket 6 - 7 - 8 - 10 - 11 - 12 - 13 - 14 - 17 - 19 mm	952
3	3/8" square drive spark plug sockets 16 - 17.8 - 20.8 mm	956E
1	pry bar	964
1	circlip pliers straight, internal 180 mm	1032A
1	circlip pliers bent, internal 170 mm	1034
1	circlip pliers straight, external 175 mm	1036
1	circlip pliers bent, external 175 mm	1038
1	slip joint pliers 240 mm	1048
1	adjustable self locking pliers 240 mm	1052
1	adjustable self locking pliers, long jaws 180 mm	1058
1	diagonal cutting nippers 160 mm	1082BM
1	electrician's scissors, straight blades	1128BMX
1	combination pliers 180 mm	1150BM
1	half-round needle nose pliers 160 mm	1166BM
1	circuit testing screwdriver 6-24V	1262
6	screwdrivers for slotted head screws 3x75 - 3.5x100 - 4x125 - 5.5x150 - 6.5x150 - 10x200 mm	1260
1	screwdriver for slotted head screws, extra-short series, 6.5x30 mm	1260N
3	screwdrivers for cross head Phillips® screws PH0x60 - PH1x80 - PH2x100 mm	1262
1	screwdriver for cross head Phillips® screws, extra-short series, PH2x30 mm	1262N
5	drivers for Torx® head screws T8 - T10 - T15 - T20 - T25	1267TX
1	engineer's hammer 300 g	1370
1	dead blow hammer Ø 35 mm	1392
1	brake spring pliers 210 mm	1470
1	crimping pliers for non insulated terminals	1603
1	measuring tape 5 m	1691A/5
1	precision feeler gauge, 20 blades	1708/20
1	flexible magnetic pick-up tool 1.8 kg	1712E/2
6	set of six needle files 160 mm	1720/B6
1	plastic oil can, flexible spout 150 cc	1754

Car repairs



Quantity/Description

Beta N.

- 6 pin punches with metal holder 2 - 3 - 4 - 5 - 6 - 8 mm
- 6 2 drift punches, 1 centre punch, 3 flat chisels with metal holder
- 19 combination wrenches 6-22 - 24 - 27 mm
- 12 offset ring wrenches 6x7 - 8x9 - 10x11 - 12x13 - 14x15 - 16x17 - 18x19 - 20x22 - 21x23 - 24x27 - 25x28 - 30x32 mm
- 7 offset hexagon key wrenches 2.5-10 mm
- 12 offset hexagon key wrenches 2-10 mm
- 13 offset key wrenches for Torx® head screws T6-T50
- 5 offset key wrenches with XZN® profile M5-M12
- 1 adjustable wrench with scale, 250 mm
- 1 1/2" click type torque wrench 40-200Nm
- 2 1/2" square drive impact sockets 17 - 19 mm
- 13 1/2" square drive bi-hex sockets with rail, 10-22 mm
- 8 1/2" square drive bi-hex sockets with rail, 23-32 mm
- 4 socket drivers for slotted screws 1.2x6.5 - 1.2x8 - 1.6x9 - 2x12 mm
- 5 socket drivers for Phillips® screws PH2 - 3 - 4
- 1 1/2" drive extension bar, 125 mm
- 1 1/2" drive extension bar, 255 mm
- 1 1/2" drive universal joint
- 1 1/2" drive swivel handle
- 1 1/2" drive sliding T-handle
- 1 1/2" drive reversible ratchet
- 7 T-handle wrenches with swivelling socket 8 - 10 - 11 - 13 - 14 - 17 - 19 mm
- 2 T-handle swivel spark plug wrenches 16 - 20.8 mm
- 1 pry bar
- 1 wheel nut wrench 17x19x22x n 1/2"
- 1 bent point tweezers 130 mm
- 1 straight large point tweezers 150 mm
- 2 circlip pliers straight, internal 140 - 180 mm
- 2 circlip pliers bent, internal 130 - 170 mm
- 2 circlip pliers straight, external 140x1.3 - 175 mm
- 2 circlip pliers bent, external 135x1.3 - 175 mm
- 1 slip joint pliers 240 mm
- 1 self locking pliers double adjustment
- 1 heavy duty diagonal cutting nippers 160 mm
- 1 toggle lever assisted end cutting nippers 180 mm
- 1 tin snips 250 mm
- 1 tin snips 200 mm
- 1 electrician's scissors, straight blades
- 1 combination pliers 180 mm
- 1 flat knurled nose pliers, 160 mm
- 1 bent needle nose pliers 200 mm
- 7 screwdrivers for slotted head screws 3x75 - 3.5x100 - 4x125 - 5.5x150 - 6.5x150 - 10x200 - 12x250 mm
- 1 screwdriver for slotted head screws with hexagon bolster 12x200 mm
- 3 screwdrivers for cross head Phillips® screws PH0x60 - PH1x80 - PH2x100 mm
- 2 engineer's hammers 300 - 600 g
- 1 soft face hammer Ø 35 mm
- 7 roller extractors 6-12 mm
- 1 adjustable oil filter wrench
- 1 circuit tester
- 1 measuring tape 5 m
- 1 feeler gauge, 20 blades
- 1 flexible magnetic pick-up tool 1.8 kg
- 1 two cutting edges scraper 200 mm
- 1 three cutting edges scraper 200 mm
- 5 second cut files 200 mm
- 1 hacksaw frame
- 1 metal oil can, flexible spout 200 cc
- 1 snap-off blade cutter

- 31/SP6
- 38/SP6
- 42
- 90/S12X
- 96N/G7
- 96/SP12
- 97TX/B13
- 98XZN/G5
- 111
- 606/20
- 720
- 920B/SB13
- 920B/SB8
- 920LP
- 920PH
- 920/21
- 920/22
- 920/25
- 920/35A
- 920/42
- 920/55
- 952
- 959
- 963
- 979
- 991
- 994
- 1032
- 1034
- 1036
- 1038
- 1048
- 1051
- 1084BM
- 1092V
- 1112
- 1114
- 1128BMX
- 1150BM
- 1162BM
- 1168BM
- 1260
- 1260E
- 1262
- 1370
- 1390
- 1434/C7
- 1491
- 1498
- 1691A/5
- 1708/20
- 1712E/2
- 1717A
- 1717B
- 1719BMA/S5
- 1726BM
- 1751
- 1771

5957VG 059570015



5700A O/VG (C57A O+5957VG) 057000092



5700A G/VG (C57A G+5957VG) 057000292



5700A R/VG (C57A R+5957VG) 057000492



5700B O/VG (C57B O+5957VG) 057000094



5700B G/VG (C57B G+5957VG) 057000294



5700B R/VG (C57B R+5957VG) 057000494

Soft thermoformed trays M-series



Assortment of tools in thermoformed trays, designed for all roller cabs and on all trolleys.

The heights of drawers C1 and C2 are shown in order to choose the most suitable thermoformed tray. Near each thermoformed tray you will find the height of the drawer it is suitable for.

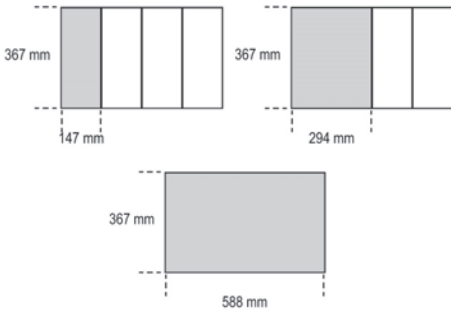
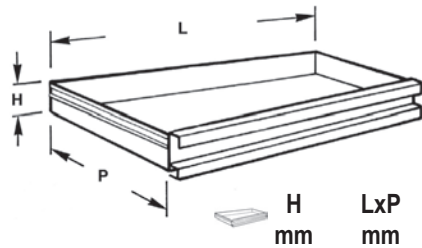

M15



42 6-7-8-9-10-11-12
13-14-15-16-17
18-19-20-21 mm

1500 g

C2



M15 1 024500015
MV15 1 024510015

M16



42 22-24-27-30-32 mm

2100 g

C2



M16 1 024500016
MV16 1 024510016

M35



55 6x7-8x9-10x11
12x13-14x15
16x17-18x19
20x22 mm
○96/SP9 1,5+10 mm

1100 g

C2



M35 1 024500035
MV35 1 024510035

M38



55 21x23-24x26
27x29-30x32 mm

1700 g

C1-C2



M38 1 024500038
MV38 1 024510038

M40



90 6x7-8x9-10x11
12x13-14x15
16x17-18x19 mm

810 g

C2



M40 1 024500040
MV40 1 024510040

M45



142 8-9-10-11-12
13-14-15-16
17-18-19 mm

1300 g

C2



M45 1 024500045
MV45 1 024510045

M46



142SN 8-9-10-11-12
13-14-15-16
17-18-19 mm

1400 g

C2



M46 1 024500046
MV46 1 024510046

M50



○96T 2-2.5-3-4-5
6-7-8 mm

1300 g

C1-C2



M50 1 024500050
MV50 1 024510050

M63



○952 7-8-10-12-13-14-17-19 mm

3400 g

C1-C2



M63 1 024500063
MV63 1 024510063

M69



951 2,5-3-4-5-6-8
10-12-14 mm

1800 g

12"

C1-C2

M69 1 024500069
MV69 1 024510069

M92



910A 6-7-8-9-10-11-12-13-
14-15-16-17-18-19-
20-21-22 mm
910/21 125 mm □ 3/8 - ■ 3/8
910/22 250 mm □ 3/8 - □ 3/8
910/25 □ 3/8 - ■ 3/8
910/42 ■ 3/8
910/55 ■ 3/8

1,5 kg

38"

C2

M92 1 024500092
MV92 1 024510092

M170



1290 2,5x50
3x75
3,5x100
4x125
5,5x100
5,5x150
6,5x150 mm

450 g

C1-C2

M170 1 024500170
MV170 1 024510170

M75



933 7-8-9-10-11-12-13-14-15
16-17-18-19-21-22-24 mm

5500 g

C2

M75 1 024500075
MV75 1 024510075

M131



1084BM 160 mm
1150BM 180 mm
1166BM 160 mm

750 g

C1-C2

M131 1 024500131
MV131 1 024510131

M172



1292 PH0x60
PH0x100
PH1x80
PH1x120
PH2x100
PH2x150 mm

450 g

C1-C2

M172 1 024500172
MV172 1 024510172

M82



920A 10-11-12-13-14
15-16-17-18-19
20-21-22-23-24
26-27-30-32 mm
920/ME 5-6-8-10-12 mm
920AN/125 125 mm
920/22 255 mm
920/25
920/42
920/55

4100 g

C2

M82 1 024500082
MV82 1 024510082

M145



1032 180 mm
1034 170 mm
1036 175 mm
1038 175 mm

640 g

C1-C2

M145 1 024500145
MV145 1 024510145

M234



35 100-200 mm
1370 300 g
1390 Ø 35 mm

1300 g

C1-C2

M234 1 024500234
MV232 1 024510232

M91



900 4-4,5-5-5,5-6-7-8-9-
10-11-12-13-14 mm
900ME 2,5-3-4-5-6-8 mm
900/20 50 mm
900/21 150 mm
900/25 □ 1/4 - ■ 1/4
900BG/30
900/42
900/55

560 g

14"

C1-C2

M91 1 024500091
MV90 1 024510090

M149



1048 240 mm
1052 240 mm

1000 g

C1-C2

M149 1 024500149
MV149 1 024510149

M236



1719BMA/Q 200 mm
1719BMA/T 200 mm
1719BMA/P 200 mm
1719BMA/M 200 mm
1719BMA/R 200 mm

870 g

C1-C2

M236 1 024500236
MV236 1 024510236

Hard thermoformed trays T-series



Assortment of tools in thermoformed trays, designed for all roller cabs and on all trolleys.

The heights of drawers C1 and C2 are shown in order to choose the most suitable thermoformed tray. Near each thermoformed tray you will find the height of the drawer it is suitable for.

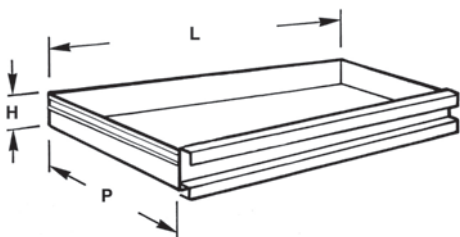

	H mm	LxP mm
C1	50	588x367
C2	80	588x367

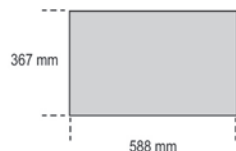
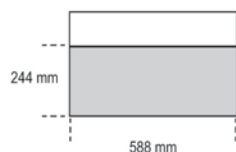
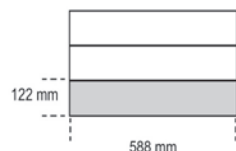
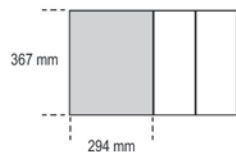
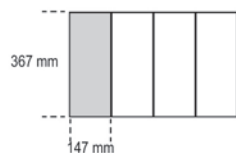

T10



42 6-7-8-10-11-12-13
14-16-17-18-19-21
22-24-27-30 mm

2710 g



T10	1	024240010
TV10	1	024000400

T15



42 6-7-8-9-10-11-12
13-14-15-16-17
18-19-20-21 mm

1500 g



T15	1	024240015
TV15	1	024000445

T16



42 22-24-27-30-32 mm

2100 g



T16	1	024240016
TV16	1	024000446

T18



42MP 6-7-8-9-10-11-12
13-14-15-16-17
18-19-20-21 mm

1500 g



T18	1	024240018
TV15	1	024000445

T19



42MP 22-24-27-30-32 mm

2100 g



T19	1	024240019
TV16	1	024000446

T20



42AS 5/16-3/8-7/16-1/2
9/16-5/8-11/16-3/4
3/32-1/8-5/32-3/16
1/4-5/16-3/8
○96AS/PL7

1040 g



T20	1	024240020
TV20	1	024000488

T30



31 Ø 2-3-4-5-6 mm
32 Ø 4 mm
55 6x7-8x9-10x11
12x13-14x15
16x17-18x19
20x22-21x23
24x26-27x29
30x32 mm
○96N/SP9 1,5÷10 mm

2940 g



T30	1	024240030
TV30	1	024000401

T35



55 6x7-8x9-10x11
12x13-14x15
16x17-18x19
20x22 mm
○96/SP9 1,5÷10 mm

1050 g



T35	1	024240035
TV20	1	024000488

T36

55MP 6x7-8x9-10x11
12x13-14x15
16x17-18x19
20x22 mm
○96/SP9 1,5+10 mm

1050 g



T36 1 024240036
TV20 1 024000488

T46

142SN 8-9-10-11-12
13-14-15-16
17-18-19 mm

1450 g



T46 1 024240046
TV46 1 024000499

T53

○96TBP 2,5-3-4-5-6 mm

300 g



T53 1 024240053
TV52 1 024000473

T40

90 6x7-8x9-10x11
12x13-14x15
16x17-18x19 mm

810 g



T40 1 024240040
TV40 1 024000456

T47

○96BPC/SP9 1,5+10 mm
142C 8-9-10-11-12
13-14-15-16
17-18-19 mm

1400 g



T47 1 024240047
TV47 1 024000763

T55

○97TTX T10-T15-T20
T25-T27-T30

330 g



T55 1 024240055
TV55 1 024000479

T41

90 20x22-21x23
24x26-25x28
27x29 mm

1550 g



T41 1 024240041
TV41 1 024000457

T50

○96T 2-2,5-3-3,5-4-4,5
5-6-7-8-10 mm

1300 g



T50 1 024240050
TV50 1 024000412

T59

111 250 mm
920/40 1/2
951 2,5-3-4-5-6-8 mm
953 4-5-6-8 mm
1370 300 - 500 g

4160 g



T59 1 024240059
TV60 1 024000420

T45

142 8-9-10-11-12
13-14-15-16
17-18-19 mm

1300 g



T45 1 024240045
TV45 1 024000498

T52

○96T 2-2,5-3-4-5-6 mm

350 g



T52 1 024240052
TV52 1 024000473



T63



○ 952 7-8-10-12-13-14-17-19 mm

3430 g

C1 - C2

T63	1	024240063
TV63	1	024000471

T64



○ 952FTX E10-E12-E14
○ 953TX T25-T27-T30-T40-T45

2420 g

C1 - C2

T64	1	024240064
TV63	1	024000471

T65



○ 953 3-3,5-4-5-6-7-8-10 mm

2510 g

C1 - C2

T65	1	024240065
TV63	1	024000471

T68



○ 951 2,5-3-4-5-6-8 mm

590 g

C1 - C2

T68	1	024240068
TV68	1	024000470

T73



○ 930 6x7-8x9-10x11-12x13-14x15-16x17-18x19-20x22 mm

1,3 kg

C2

T73	1	024240073
TV73	1	024000418

T75



○ 933 7-8-9-10-11-12-13-14-15-16-17-18-19-21-22-24 mm

4155 g

C2

T75	1	024240075
TV75	1	024000422

T76



○ 932 7-8-9-10-11-12-13-14-15-16-17-18-19-21-22-24 mm

4155 g

C2

T76	1	024240076
TV75	1	024000422

T77



○ 933 6-7-8-10-11-12-13-14-17-19 mm

1440 g

C2

T77	1	024240077
TV77	1	024000474

T79



80 8x9-10x11-12x13-14x15-16x17-18x19 mm

1300 g

C2

T79	1	024240079
TV79	1	024000490

T80

- 920A 10-11-12-13-14
15-16-17-18-19
20-21-22-23-24
26-27-30-32 mm
- 920ME 5-6-8-10-12 mm
- 920/21 125 mm
- 920/22 255 mm
- 920/25
- 920/42 305 mm
- 920/55

4100 g

12"

C2



T80 1 024240080
TV80 1 024000403

T92

- 910A 6-7-8-9-10-11-12-13
14-15-16-17-18-19
20-21-22 mm
- 910/21 125 mm
- 910/22 250 mm
- 910/25
- 910/42 210 mm
- 910/55

1550 g

38"

C2



T92 1 024240092
TV92 1 024000458

T105

- 928A 22-24-27-30-32-34
36-38-41-46-50 mm

4900 g

34"

C2



T105 1 024240105
TV105 1 024000484

T81

- 920B 10-11-12-13-14
15-16-17-18-19
20-21-22-23-24
26-27-30-32 mm
- 920ME 5-6-8-10-12 mm
- 920/21 125 mm
- 920/22 255 mm
- 920/25
- 920/42 305 mm
- 920/55

4050 g

12"

C2



T81 1 024240081
TV80 1 024000403

T100

- 920A 10-12-13-14-15
16-17-18-19-21
22-24 mm
- 920/21 125 mm
- 920/25
- 920/42 305 mm
- 920/55

2110 g

12"

C2



T100 1 024240100
TV100 1 024000495

T106

- 928/21 200 mm
- 928/22 380 mm
- 928/42 450 mm
- 928/55

4460 g

34"

C2



T106 1 024240106
TV106 1 024000485

T82

- 920A 10-11-12-13-14
15-16-17-18-19
20-21-22-23-24
26-27-30-32 mm
- 920ME 5-6-8-10-12 mm
- 920AN/125 125 mm
- 920AN/250 250 mm
- 920/25
- 920/42 305 mm
- 920/55

4100 g

12"

C2



T82 1 024240082
TV80 1 024000403

T101

- 920B 10-12-13-14-15
16-17-18-19-21
22-24 mm
- 920/21 125 mm
- 920/25
- 920/42 305 mm
- 920/55

2110 g

12"

C2



T101 1 024240101
TV100 1 024000495

T110

- 720 10-11-12-13-14
16-17-18-19-21
22-23-24 mm
- 720/21 125 mm

1830 g

12"

C2



T110 1 024240110
TV110 1 024000477

T91

- 900 4-4.5-5-5.5-6
7-8-9-10-11
12-13-14 mm
- 900ME 2,5-3-4-5-6-8 mm
- 900/20 50 mm
- 900/21 150 mm
- 900/25
- 900BG/30
- 900/42 115 mm
- 900/55

560 g

14"

C1 - C2



T91 1 024240091
TV90 1 024000447

T102

- 920AS 3/8-7/16-1/2
9/16-5/8-11/16
3/4-13/16-7/8
15/16-1.1/16
- 920/21 125 mm
- 920/25
- 920/42 305 mm
- 920/55

2110 g

12"

C2



T102 1 024240102
TV100 1 024000495

T112

- 861TX ● 1/4-T6+T15
- 866TX ● 5/16-T20+T55
- 895/1 ○ 1/4x□1/4
- 895/6 ○ 5/16x□1/2
- 900FTX □ 1/4-E4+E10
- 920FTX □ 1/2-E12+E24
- 920TX □ 1/2-T55L-T60-T70L

1320 g

C2



T112 1 024240112
TV112 1 024000480

T113



- 920PE 5L-6L-7L-8L-10L
- 920TX T40L-T45L
T55L-T70L
- 920XZN M6L-M8L-M12L

1450 g

12"

C2



T113	1	024240113
TV113	1	024000489

T135



- 1082MQ 160 mm
- 1150MQ 180 mm
- 1166MQ 160 mm

△1000 V

750 g

C1 - C2



T135	1	024240135
TV135	1	024000762

T146



- 1032 140 mm
- 1032 225 mm
- 1036 140x1,3 mm
- 1036 225 mm

700 g

C1 - C2



T146	1	024240146
TV146	1	024000449

T120



606/20 200 Nm

1080 g

12"

C2



T120	1	024240120
TV120	1	024000483

T140



- 1032 140 - 180 mm
- 1034 170 mm
- 1036 140x1,3 - 175 mm
- 1038 175 mm
- 1084 160 mm
- 1128BM

1140 g

C1 - C2



T140	1	024240140
TV140	1	024000405

T147



- 1048 240 mm
- 1084BM 160 mm
- 1150BM 180 mm

800 g

C1 - C2



T147	1	024240147
TV148	1	024000500

T131



- 1084BM 160 mm
- 1150BM 180 mm
- 1166BM 160 mm

750 g

C1 - C2



T131	1	024240131
TV130	1	024000451

T143



- 1048 240 mm
- 1052 240 mm
- 1112 250 mm
- 1150 180 mm

1760 g

C1 - C2



T143	1	024240143
TV143	1	024000409

T149



- 1048 240 mm
- 1052 240 mm

1000 g

C1 - C2



T149	1	024240149
TV150	1	024000462

T132



- 1084 160 mm
- 1150 180 mm
- 1166 160 mm

650 g

C1 - C2



T132	1	024240132
TV130	1	024000451

T145



- 1032 180 mm
- 1034 170 mm
- 1036 175 mm
- 1038 175 mm

640 g

C1 - C2



T145	1	024240145
TV145	1	024000448

T151



- 1047 240 mm
- 1057 240 mm

1300 g

C2



T151	1	024240151
TV150	1	024000462

T160



- 1290 3x75
3x100
4x100
4x150
5,5x100
5,5x150
6,5x150
8x150
10x200 mm
- 1290N 4x30
6,5x30 mm

C1 - C2



1120 g

T160	1	024240160
TV160	1	024000706

T167



- 1260 3x75
3x100
4x100
4x150
5,5x100
5,5x150
6,5x150
8x150
10x200 mm
- 1260N 4x30
6,5x30 mm

880 g

T167	1	024240167
TV160	1	024000706

T172



- ⊕ 1292 PH0x60
PH0x100
PH1x80
PH1x120
PH2x100
PH2x150 mm

450 g

T172	1	024240172
TV172	1	024000743

T161



- ⊕ 1292 PH0x60
PH0x100
PH1x80
PH1x120
PH2x100
PH2x150
PH3x150 mm
- ⊕ 1292N PH1x30
PH2x30 mm

C1 - C2



720 g

T161	1	024240161
TV161	1	024000707

T168



- ⊕ 1262 PH0x60
PH0x100
PH1x80
PH1x120
PH2x100
PH2x150
PH3x150 mm
- ⊕ 1262N PH1x30
PH2x30 mm

710 g

T168	1	024240168
TV161	1	024000707

T173



- ⊕ 1292 PH3x150
PH4x200 mm
- ⊕ 1292N PH1x30
PH2x30 mm

560 g

T173	1	024240173
TV173	1	024000744

T164



- 952 8-10-13-17-19 mm
- 959 16 mm (5/8") - 20,8 mm (13/16")
- 1260 3x75-4x100-5,5x100
6,5x150-10x200 mm
- ⊕ 1262 PH0x60-PH1x80
PH2x100-PH3x150 mm

C1 - C2



4960 g

T164	1	024240164
TV61	1	024000721

T170



- 1290 2,5x50
3x75
3,5x100
4x125
5,5x100
5,5x150
6,5x150 mm

450 g

T170	1	024240170
TV170	1	024000741

T175



- ⊕ 1297TX T6-T7-T8-T9
T10-T15-T20

410 g

T175	1	024240175
TV175	1	024000760

T171



- 1290 8x150
8x200
10x200 mm
- 1290N 4x30
6,5x30 mm

750 g

T171	1	024240171
TV171	1	024000742

T176



- ⊕ 1297TX T25-T27-T30
T40-T45

640 g

T176	1	024240176
TV176	1	024000761



T177**Betamax**
MAXIMUM PERFORMANCE

1298RTX T9-T10-T15
T20-T25-T27
T30-T40

680 g

C1 - C2

T177	1	024240177
TV177	1	024000759

T201

1260 8x200
10x150
10x200 mm

1260N 4x30
6,5x30 mm

680 g

C1 - C2

T201	1	024240201
TV171	1	024000742

T206

1267TX T25-T27-T30
T40-T45

710 g

C1 - C2

T206	1	024240206
TV176	1	024000761

T180**Betamax**
MAXIMUM PERFORMANCE

1290 3x75
4x100
5,5x150
6,5x150 mm

1292 PH0x60
PH1x80
PH2x100 mm

480 g

C1 - C2

T180	1	024240180
TV180	1	024000701

T202

1262 PH0x60
PH0x100
PH1x80
PH1x120
PH2x100
PH2x150 mm

490 g

C1 - C2

T202	1	024240202
TV172	1	024000743

T207

1268RTX T9-T10-T15
T20-T25-T27
T30-T40

760 g

C1 - C2

T207	1	024240207
TV207	1	024000758

T183**Betamax**
MAXIMUM PERFORMANCE

1292L PH1x400-PH2x400 mm

1294L 3x300-4x400-5x400 mm

580 g

C2

T183	1	024240183
TV183	1	024000497

T204

1262 PH3x150
PH4x200 mm

1262N PH1x30
PH2x30 mm

610 g

C1 - C2

T204	1	024240204
TV173	1	024000744

T208

1260 3x75
4x100
5,5x150
6,5x150 mm

1262 PH0x60
PH1x80
PH2x100 mm

530 g

C1 - C2

T208	1	024240208
TV180	1	024000701

T199

1260 2,5x50
3x75
3,5x100
4x125
5,5x100
5,5x150
6,5x150 mm

490 g

C1 - C2

T199	1	024240199
TV170	1	024000741

T205

1267TX T6-T7-T8-T9
T10-T15-T20

460 g

C1 - C2

T205	1	024240205
TV175	1	024000760

T209

1262L PH1x400-PH2x400 mm

1264L 3x300-4x400-5x400 mm

580 g

C2

T209	1	024240209
TV183	1	024000497

T210

- 1201 2,5x50
3x75
3,5x100
4x125
5,5x100
5,5x150
6,5x150 mm

490 g

C1 - C2

- T210 1 024240210
- TV170 1 024000741

T225

- 1274MQ 3x100
4x100
5,5x125
6,5x150 mm
- 1272MQ PH0x60
PH1x80
PH2x100 mm

1000 V

460 g

C1 - C2

- T225 1 024240225
- TV180 1 024000701

T212

- 1202 PH0x60
PH1x80
PH1x120
PH2x100
PH2x150
PH3x150 mm

490 g

C1 - C2

- T212 1 024240212
- TV212 1 024000440

T231

- 1370 400 g
- 1390 Ø 35 mm
- 1719BMA/T 200 mm
- 1719BMA/P 200 mm
- 1719BMA/M 200 mm

1650 g

C2

- T231 1 024240231
- TV230 1 024000411

T236

- 1719BMA/Q 200 mm
- 1719BMA/T 200 mm
- 1719BMA/P 200 mm
- 1719BMA/M 200 mm
- 1719BMA/R 200 mm

870 g

C1 - C2

- T236 1 024240236
- TV235 1 024000453

T215

- 1207TX T6-T7-T8-T9
T10-T15-T20

410 g

C1 - C2

- T215 1 024240215
- TV175 1 024000760

T233

- 35 100-200 mm
- 1370F 32 mm
- 1390 Ø 35 mm

1300 g

C1 - C2

- T233 1 024240233
- TV232 1 024000452

T241

- 1500N/1
- 1500N/3
- 1516/1

4200 g

C2

- T241 1 024240241
- TV241 1 024000414

T220

- 1201 3x75
4x100
5,5x150
6,5x150 mm
- 1202 PH0x60
PH1x80
PH2x100 mm

530 g

C1 - C2

- T220 1 024240220
- TV180 1 024000701

T234

- 35 100-200 mm
- 1370 300 g
- 1390 Ø 35 mm

1300 g

C1 - C2

- T234 1 024240234
- TV232 1 024000452

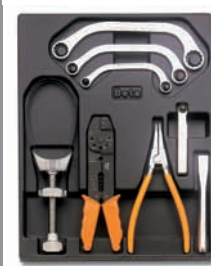
T250**Automotive**

- 34 150 mm
- 83/S3 11x13-14x17
19x22 mm
- 1458 175 mm
- 1491
- 1603
- 1708/13 0,05+1 mm

1430 g

C1 - C2

- T250 1 024240250
- TV250 1 024000408



T255

Automotive



956E	16 mm (5/8) - 20,8 mm (13/16)
956L	16 mm (5/8) - 20,8 mm (13/16)
959	16 mm (5/8) - 20,8 mm (13/16)
1474	200 mm
1708/20	0,05+1 mm

3180 g

C2

T255	1 024240255
TV255	1 024000467

T263



○96BP	2,5-3-4-5 6-8-10 mm
○96N	12 mm
861MIX/S31	
895/1	

450 g

C2

T263	1 024240263
TV263	1 024000492

T270



430	M3 - 4 - 5 - 6 - 7 - 8 - 9 10 - 12 - 14 - 16 - 18 - 20
433	M6x0,75 - M8x1 - M10x1,25 M12x1,5 - M14x1,5 M16x1,5 - M18x1,5
440	M3 - 4 - 5 - 6 - 7 - 8 - 9
440A	M10 - 12 - 14 - 16 - 18 - 20
441	M6x0,75 - M8x1,0
441A	M10x1,25 - M12x1,5 M14x1,5 - M16x1,5 M18x1,5

4280 g

C2

T270	1 024240270
TV270	1 024000481

T273



435/1,5	M3+M12
435/3	M5+M21
436/1	□ 2,0+5,0 mm (M3+M8)
436/2	□ 4,6+8 mm (M5+M12)
444/1	∅ 25,4 mm
444/2	∅ 38,1 mm
1707	W 62+4x1"

2100 g

C2

T273	1 024240273
TV272	1 024000482

T281



1741B	250 mm
1741BRV	2,9x6 mm (100)
1741BRV	3,2x8 mm (100)
1741BRV	3,8x10 mm (100)
1741BRV	4x12 mm (100)

1420 g

C2

T281	1 024240281
TV280	1 024000478

T285



1112	250 mm
1128BM	-
1726	400 mm
1728BM	(5)
1753	200 cc

1550 g

C2

T285	1 024240285
TV285	1 024000487



Beta



T289



1692/5	5 m
1725CR	-
1755	30 cc
1771	-

500 g

C2

T289	1 024240289
TV290	1 024000455

T291



1479RB/1	
1479RB/2	
1479RB/3	

600 g

C2

T291	1 024240291
TV291	1 024000472

T295



1650	-
1682	300 mm
1707	-
1708/20	0,05+1 mm

490 g

C1 - C2

T295	1 024240295
TV295	1 024000454

VP1 - VP2

thermoformed trays for small items,
made from plastic
for all roller cabs C22, C23, C23C

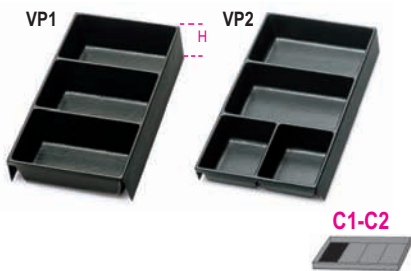

	H mm		
VP1	50	1	088880351
VP2	35	1	088880352

VP3 - VP4

thermoformed trays for small items,
made from plastic
for all roller cabs and all trolleys

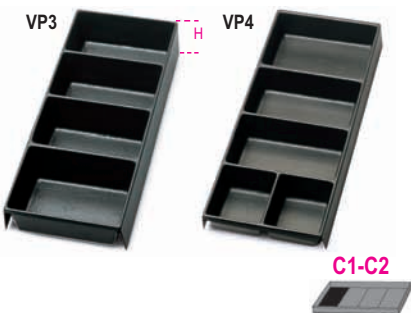

	H mm		
VP3	50	1	088880353
VP4	35	1	088880354

VP5

thermoformed tray



VP5	1	088880355
-----	---	-----------

VP6

thermoformed tray



VP6	1	088880359
-----	---	-----------

VP-3SC

thermoformed tool trays,
made from plastic,
for mobile roller cab C38

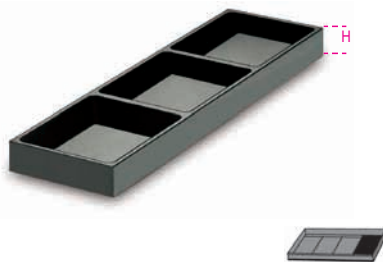

VP-3SC	H mm	1	088880356
	45		

VP-LS

thermoformed tool trays,
made from plastic,
for mobile roller cab C38



VP-LS	H mm	1	088880357
	45		

VP-LD

thermoformed tool trays,
made from plastic,
for mobile roller cab C38



VP-LD	H mm	1	088880358
	45		

GA/C38-C

supporting unit for item C38



GA/C38-C	5	088880370
----------	---	-----------

GA/C38-SX

supporting unit for item C38



GA/C38-SX	5	088880372
-----------	---	-----------

GA/C38-DX

supporting unit for item C38



GA/C38-DX	5	088880371
-----------	---	-----------

SL/C38

longitudinal partition for item C38



SL/C38	5	088880381
--------	---	-----------

ST/C38-C

transverse partition for item C38



ST/C38-C	5	088880391
----------	---	-----------

ST/C38-SX

transverse partition for item C38



ST/C38-SX	5	088880393
-----------	---	-----------

ST/C38-DX

transverse partition for item C38



ST/C38-DX	5	088880392
-----------	---	-----------

GA/C41

supporting unit for item C41



GA/C41	5	088880340
--------	---	-----------

SL/C41

longitudinal partition for item C41

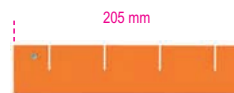

SL/C41	5	088880341
--------	---	-----------

ST/C41

transverse partition for item C41

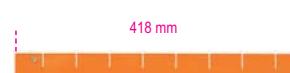

ST/C41	5	088880346
--------	---	-----------

Partitions for mobile roller cabs and trolleys

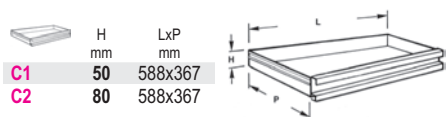

	H mm	LxP mm
C1	50	588x367
C2	80	588x367

Partitions for tool chests C22, C23, C23C

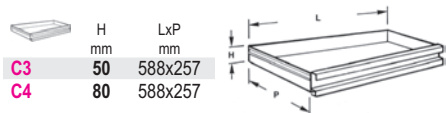

	H mm	LxP mm
C3	50	588x257
C4	80	588x257

GA

supporting unit



GA	10	088880300
----	----	-----------

SL1 - SL2

longitudinal partitions



SL1	10	088880301
SL2	10	088880302

SL3 - SL4

longitudinal partitions



SL3	10	088880303
SL4	10	088880304

ST1 - ST2

transverse partitions



ST1	10	088880311
ST2	10	088880312

GL1 - GL2

partition combinations, parallel



GL1	1	088880321
GL2	1	088880322

GL3 - GL4

partition combinations, parallel



GL3	1	088880323
GL4	1	088880324

TL1 - TL2

partition combinations, crossed



TL1	1	088880331
TL2	1	088880332

TL3 - TL4

partition combinations, crossed



TL3	1	088880333
TL4	1	088880334

SB

socket rails



	L mm	
SB1	210	10 088880201
SB2	280	10 088880202
SB3	360	10 088880203

MB

socket clips for rails SB



MB0	1/4	50	088880210
MB1	3/8	50	088880211
MB2	1/2	50	088880212

TV - TOV

perforated sheet steel panel



with support

TV	46x75 cm	2	088880001
----	----------	---	-----------

without support

TOV	46x75 cm	2	088880002
-----	----------	---	-----------

KIT/GPS

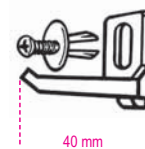

KIT/GPS	10	088880119
---------	----	-----------

VE1



VE1	20	088880120
-----	----	-----------

GM



Ø mm	
6,5	5 088880250
9,5	5 088880251
13	5 088880252
16	5 088880253
19	5 088880254
25	5 088880255

S55/8

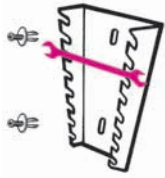

1 088880400

S55/8
55-55MP: 6x7-8x9-10x11
12x13-14x15-16x17
18x19-20x22 mm

S55/12

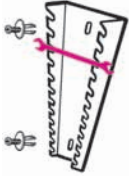

1 088880401

S55/12
55-55MP: 6x7-8x9-10x11
12x13-14x15-16x17
18x19-20x22-21x23
24x26-25x28-30x32 mm

TSPP

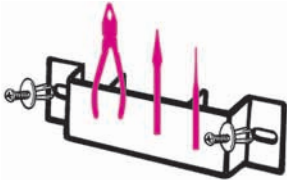

1 088880402

TSPP

S952

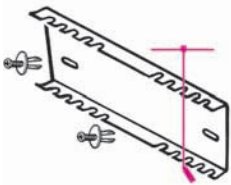

1 088880403

S952
952: 6-7-8-10-11
12-13-14-17-19 mm

S1719BM



1 088880404

S1719BM
1719BMA: Q-T-P-M-R

SGN



1 088880405

SGN
1290N-1292N-1299N/PZ
1260N-1262N-1279N/PZ
1201N-1202N

CB/2

only for C54

12"

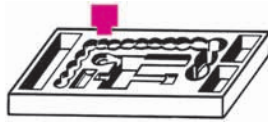

1 088880411

CB/2
920A/920B
10+24+26-27
28-30-32 mm

S42/18

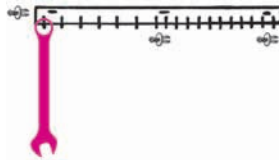

1 088880408

S42/18
42-42MP: 6+22+24 mm
42-42MP: 6+14+16-17
18-19-21-22-24-27-30 mm

S951/6

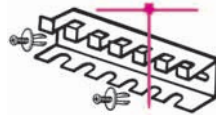

1 088880409

S951/6
951: 2,5-3-4-5-6-8 mm

SP G9 - SP G11

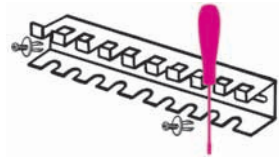

1 088880909

SP G9
n.6 Ø = 7 mm
n.2 Ø = 10 mm
n.1 Ø = 12 mm

1 088880910

SP G11
n.8 Ø = 7 mm
n.2 Ø = 10 mm
n.1 Ø = 12 mm

96/SPV



1 000960400

96/SPV

96T/SPV

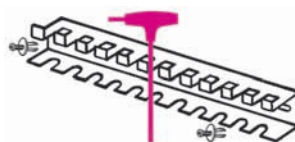

1 000960958

96T/SPV

Beta





Blister pack range for your free-service sales!



Increased visibility

Bar code

Display efficiency

BLISTER PACK SUPPORT:

- tearproof PVC
- 3 formats for optimized display space
- New-generation fixing system with elastic band

42K



mm		
6x6	10	000429006
7x7	10	000429007
8x8	10	000429008
9x9	10	000429009
10x10	10	000429010
11x11	10	000429011
12x12	10	000429012
13x13	10	000429013
14x14	10	000429014
15x15	10	000429015
16x16	10	000429016
17x17	10	000429017
18x18	10	000429018
19x19	10	000429019
20x20	5	000429020
21x21	5	000429021
22x22	5	000429022
23x23	5	000429023
24x24	5	000429024
27x27	5	000429027
30x30	5	000429030
32x32	5	000429032

55K



mm		
6x7	10	000559012
8x9	10	000559021
10x11	10	000559030
12x13	10	000559042
14x15	10	000559054
16x17	10	000559060
18x19	5	000559066
20x22	5	000559075

93K



mm		
21x22	3	000939021

96/PL7K



96PL7K	1	000969371

2,5-3-4-5-6-8-10

96/SP9K



96/SP9K	5	000969384

1,5-2-2,5-3
4-5-6-8-10

96TK



mm		
2	5	000969934
2,5	5	000969935
3	5	000969936
4	5	000969938
5	5	000969940
6	5	000969941

111K



L mm		
150	1	001119015
200	1	001119020
250	1	001119025

142K



L mm		
8	3	001429008
10	3	001429010
13	3	001429013
17	2	001429017
19	2	001429019

195K



mm		
8x10	2	001959010
12x13	2	001959013
14x15	2	001959015
16x18	2	001959018
17x19	2	001959019

900K



mm		
4	10	009009040
4,5	10	009009045
5	10	009009050
5,5	10	009009055
6	10	009009060
7	10	009009070
8	10	009009080
9	10	009009090
10	10	009009100
11	10	009009110
12	10	009009120
13	10	009009130
14	10	009009140

Beta



900/20LK**14"**

L mm		
100	5	009009819

900/25K**14"**

L mm		
41	5	009009830

900BG/30K

L mm		
128	1	009009834

900/55K**14"**

L mm		
125	5	009009870

920AK**12"**

Ø mm		
10	10	009209010
11	10	009209011
12	10	009209012
13	10	009209013
14	10	009209014
15	10	009209015
16	10	009209016
17	10	009209017
18	10	009209018
19	10	009209019
20	5	009209020
21	5	009209021
22	5	009209022
23	5	009209023
24	5	009209024
25	5	009209025
26	5	009209026
27	5	009209027
28	5	009209028
29	5	009209029
30	5	009209030
32	5	009209032

920/21K**12"**

L mm		
125	5	009209822

920/25K**12"**

L mm		
75	5	009209830

920/55K**12"**

L mm		
275	3	009209882

935K

Ø mm		
6x7	5	009359105
8x9	5	009359111
10x11	5	009359115
12x13	5	009359117
14x15	5	009359126
16x17	5	009359128
18x19	5	009359131
20x22	3	009359138

937K

Ø mm		
6x6	5	009379006
7x7	5	009379007
8x8	5	009379008
9x9	5	009379009
10x10	5	009379010
11x11	5	009379011
12x12	5	009379012
13x13	5	009379013
14x14	5	009379014
15x15	5	009379015
16x16	5	009379016
17x17	5	009379017
18x18	5	009379018
19x19	5	009379019
20x20	5	009379020
21x21	3	009379021
22x22	3	009379022

951K

mm		
2,5	5	009519525
3	5	009519530
4	5	009519540
5	5	009519550
6	5	009519560
8	5	009519580

1032K

L mm		
180	5	010329017

1034K

L -		
170	5	010349017

1036K

L -		
175	5	010369017

1038K

L -		
175	5	010389017

1044K

L -		
240	5	010449240

1048VK

L ~ 240 5 010489024

1048K

L ~ 240 5 010489240

1052K

L ~ 190 3 010529019
L ~ 240 3 010529024

1082BMK

L ~ 160 3 010829036

1084BMK

L ~ 160 3 010849036

1098K

L ~ 190 5 010989190
L ~ 220 5 010989220

1122K

L ~ 250 2 011229020

1123K

L ~ 250 2 011239020

1124K

L ~ 250 2 011249020

1129BMK

L mm 145 5 011299000

1142BMK

L mm 160 3 011429036

1150BMK

L ~ 160 3 011509036
L ~ 180 3 011509038
L ~ 200 3 011509040

1162BMK

L ~ 160 3 011629036

1166BMK

L ~ 160 3 011669036

1168BMK

L ~ 160 3 011689036



1201K



SxAxL mm		
0,4x2,5x50	5	012019003
0,5x3x75	5	012019009
0,6x3,5x100	5	012019021
0,8x4x100	5	012019030
0,8x4x125	5	012019033
1,0x5,5x100	5	012019039
1,0x5,5x150	5	012019042
1,2x6,5x150	5	012019051
1,2x8x150	3	012019057
1,6x10x200	3	012019066

1201NK

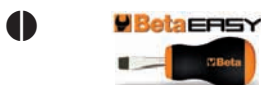

SxAxL mm		
0,8x4x30	3	012019103
1,2x6,5x30	3	012019106

1202K



PHxDxL mm		
0x3x60	5	012029003
1x4,5x80	5	012029009
2x6x100	5	012029018
3x8x150	3	012029024

1202NK



PHxDxL mm		
1x4,5x30	3	012029103
2x6x30	3	012029106

1207TXK



T6	5	012079006
T7	5	012079007
T8	5	012079008
T9	5	012079009
T10	5	012079010
T15	5	012079015
T20	5	012079020
T25	5	012079025
T27	5	012079027
T30	5	012079030

1209PZK



PZ		
0	5	012099000
1	5	012099003
2	5	012099006
3	3	012099009

1603B/K



mm ² 0÷8	2	016039010

1741BK



Ø mm	2,4	3,2	4	4,8	5
Aluminium	•	•	•	•	•
Steel	•	•	•	•	•
Stainless steel	•	•	•		

1741BK		
	1	017419002

1762K



Ø mm		
2-2,5-3 3,5-4-4,5	2	017629001

1770A/K



1770A/K		
	10	017709025



Beta
SHOP
in shop

Beta SHOP *in Shop*

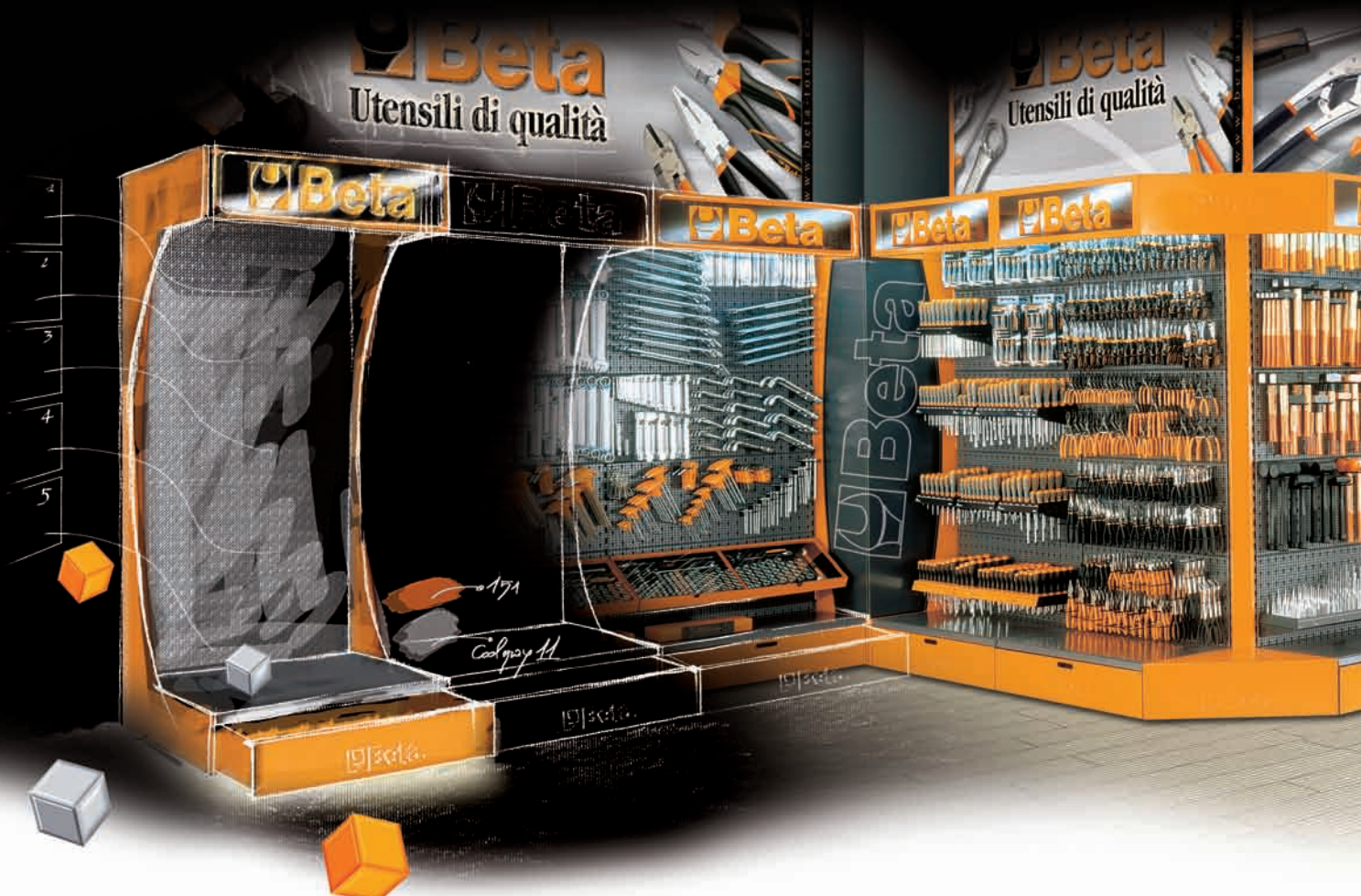

**DISPLAY UNITS
FOR SALES
POINTS**

38/DS1

wall-mounted display
with 75 punches

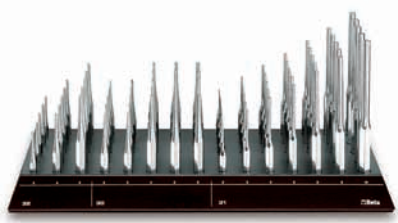

495x260x332 mm

display
with assortment

1 000380701

		n.
30	Ø 2 - 3 - 4 - 5 - 6 mm	5
31	Ø 2 - 3 - 4 - 5 - 6 - 8 - 10 mm	5
32	Ø 3 - 4 - 5 mm	5

empty
display

38/DVS1 1 000380751

38/DS2

wall-mounted display
with 65 chisels

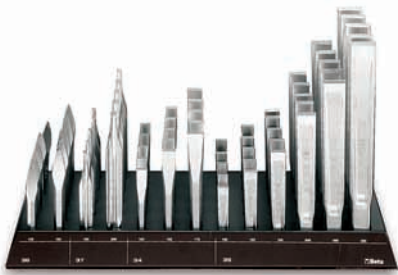

495x260x332 mm

display
with assortment

1 000380702

		n.
34	125 - 150 - 175 mm	5
35	100 - 125 - 150 - 200 - 250 - 300 mm	5
36	125 - 150 mm	5
37	150 - 200 mm	5

empty
display

38/DVS2 1 000380752

942BX/DG

wall-mounted display
with 43 hi-torque hexagon nut spinners,
short series



330x260x332 mm

display
with assortment

942BX/DG 1 009420701

		n.
942BX	5 - 5,5 mm	3
	6 - 7 mm	6
	8 - 9 - 10 mm	5
	11 mm	2
	12 mm	3
	13 mm	5

empty
display

942BX/DVG 1 009420751

943BX/DG

wall-mounted display
with 43 hi-torque hexagon nut spinners,
long series



330x260x332 mm

display
with assortment

943BX/DG 1 009430701

		n.
943BX	5 - 5,5 mm	3
	6 - 7 mm	6
	8 - 9 - 10 mm	5
	11 mm	2
	12 mm	3
	13 mm	5

empty
display

943BX/DVG 1 009430751

943MQ/DG

wall-mounted display
with 30 hexagon nut spinners

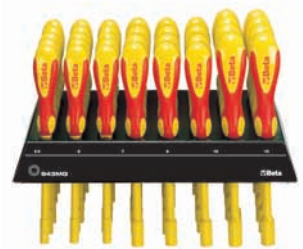

⚠ 1000 V ⚡

330x260x332 mm

display
with assortment

943MQ/DG 1 009430981

		n.
943MQ	5,5 - 6 - 7 - 8 - 10 - 13 mm	5

empty
display

943MQ/DVG 1 009430985



1203/E1P

wall-mounted display with 82 screwdrivers

Beta EASY



495x260x310 mm

display
with assortment



1203/E1P 1 012030301

		n.
● 1201	0,4x2,5x50 - 0,5x3x75 - 0,6x3,5x100	7
	0,8x4x100 - 0,8x4x125 mm	
	1,0x5,5x100 - 1,0x5,5x150 - 1,2x6,5x150 mm	6
	1,2x8x150 mm	5
⊕ 1202	PH0x3x60 mm	7
	PH1x4,5x80 - PH2x6x100 mm	6
	PH3x8x150 mm	5

empty
display



1203/EV1P 1 012030351

1203/E4P

wall-mounted display with 85 screwdrivers

Beta EASY



495x260x310 mm

display
with assortment



1203/E4P 1 012030304

		n.
● 1201	0,4x2,5x50 - 0,5x3x75 - 0,8x4x125 mm	7
	1,0x5,5x100 - 1,0x5,5x150 - 1,2x6,5x150 mm	6
	● 1204	0,4x2,5x60 - 0,5x3x100 - 0,8x4x100 mm
	1,0x5x125 mm	6
⊕ 1209PZ	PZ0x3x60 mm	7
	PZ1x4,5x80 - PZ2x6x100 mm	6

empty
display



1203/EV4P 1 012030354

1203/E5P

wall-mounted display with 82 screwdrivers

Beta EASY

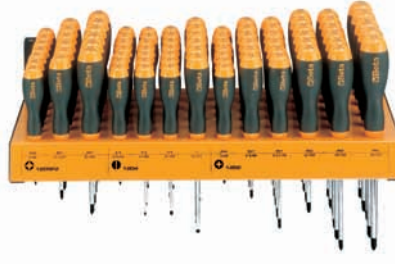

495x260x310 mm

display
with assortment



1203/E5P 1 012030305

		n.
⊕ 1202	PH0x3x60 mm	7
	PH1x4,5x80 - PH1x4,5x120	6
	PH2x6x100 - PH2x6x150 mm	
	PH3x8x150 mm	5
● 1204	0,4x2,5x60 - 0,5x3x100 - 0,8x4x100 mm	7
	1,0x5x125 mm	6
⊕ 1209PZ	PZ0x3x60 mm	7
	PZ1x4,5x80 - PZ2x6x100 mm	6

empty
display



1203/EV5P 1 012030355

1203/E10P

wall-mounted display with 80 screwdrivers

Beta EASY



495x260x310 mm

display
with assortment



1203/E10P 1 012030310

		n.
● 1207TX	T6	4
	T7	3
	T8	7
	T9 - T10 - T15 - T20 - T25	6
	T27 - T30	3
⊕ 1208TX	T9 - T10	3
	T15 - T20 - T25	6
	T27 - T30	3

empty
display



1203/EV10P 1 012030360

1263/E80

wall-mounted and counter display
with 80 screwdrivers

Beta GRIP



467x325x450 mm



1263/E80 1 012630500

		n.
● 1260	2,5x50 mm	4
	2,5x75 mm	2
	3x75 mm	5
	3x100 mm	3
	3,5x100 mm	4
	4x100 mm	5
	4x125 mm	3
	5,5x125 mm	5
	5,5x150 - 6,5x125 mm	3
	6,5x150 mm	5
	8x200 mm	2
● 1260N	4x30 - 6,5x30 mm	2
⊕ 1262	PH0x60 mm	5
	PH0x100 mm	3
	PH1x80 mm	5
	PH1x120 mm	4
	PH2x100 mm	5
	PH2x150 mm	4
	PH3x150 mm	2
⊕ 1262N	PH1x30 - PH2x30 mm	2



1263/EV80 1 012630501

Beta

ISO 9001

1263/E85

wall-mounted display
with 85 screwdrivers



495x260x377 mm



1263/E85 1 012630550

		n.
● 1260	2,5x50 mm	7
	2,5x75 mm	6
	3x75 - 3x100 - 3,5x100 mm	7
	4x100 - 4x125 - 5,5x125	6
	5,5x150 - 6,5x150 mm	
	8x150 mm	4
● 1260E	10x200 mm	3
	12x250 mm	2
● 1260N	4x30 - 6,5x30 mm	6



1263/EV85 1 012630551

1263/E70

wall-mounted display
with 70 screwdrivers



495x260x327 mm



1263/E70 1 012630560

		n.
⊕ 1262	PH0x60 - PH0x100 mm	7
	PH1x80 - PH1x120 mm	6
	PH2x100 mm	9
	PH2x150 - PH3x150 mm	5
	PH4x200 mm	4
⊕ 1262E	PH2x150 mm	5
	PH3x175 mm	4
⊕ 1262N	PH1x30 - PH2x30 mm	6



1263/EV70 1 012630561

1263/E50

wall-mounted display
with 50 screwdrivers



330x260x269 mm



1263/E50 1 012630570

		n.
● 1264	2,5x60 - 3x75 - 3x100 mm	7
	4x100 - 4x125 - 5x125 - 5x150 mm	6
	6,5x150 mm	5



1263/EV50 1 012630571

1263/E62

wall-mounted display
with 62 screwdrivers



495x260x257 mm



1263/E62 1 012630590

		n.
⊕ 1267TX	T5	5
	T6	6
	T7	5
	T8	6
	T9	5
	T10 - T15 - T20	6
	T25	5
	T27 - T30	4
	T40 - T45	2



1263/EV62 1 012630591

1263/E39

wall-mounted display
with 39 screwdrivers



330x260x257 mm



1263/E39 1 012630595

		n.
⊕ 1268RTX	T9x60 - T10x80 - T15x80	6
	T20x100 - T25x100 mm	
	T27x115 mm	4
	T30x115 mm	3
	T40x130 mm	2



1263/EV39 1 012630596

1263/E40

wall-mounted display
with 40 screwdrivers



330x260x327 mm



1263/E40 1 012630580

		n.
⊕ 1269	PZ0x60 mm	7
	PZ1x80 mm	6
	PZ2x100 - PZ3x150 - PZ4x200 mm	5
⊕ 1269N	PZ1x30 - PZ2x30 mm	6



1263/EV40 1 012630581

1273MQ/E1

wall-mounted display with 40 screwdrivers



△ 1000 V ⚡

330x260x332 mm

display
with assortment



1273MQ/E1 1 012730311

		n.
⊕ 1272MQ	PH0x60 - PH1x80 mm	5
	PH2x100 mm	3
	PH3x150 mm	2
● 1274MQ	3x100 - 4x100 - 5,5x125 - 6,5x150 mm	5
	8x175 mm	3
	10x200 mm	2

empty
display



1273MQ/DVG 1 012730751

1293BX/DB

wall-mounted display with 89 screwdrivers



495x260x332 mm

display
with assortment



1293BX/DB 1 012930702

		n.
● 1290	2,5x50 - 3x75 - 3x100 - 3,5x100	7
	4x100 - 4x125 - 5,5x100 - 5,5x150 mm	6
	6,5x150 mm	5
	8x150 mm	5
● 1290N	4x30 - 6,5x30 mm	6
● 1290E	10x175 - 12x200 mm	5

empty
display



1293BX/DVB 1 012930752

1293BX/DD

wall-mounted display with 48 screwdrivers



330x260x332 mm

display
with assortment



1293BX/DD 1 012930704

		n.
● 1294	2,5x60 - 3x75 - 3x100 - 4x100	7
	4x150 - 5x125 mm	6
	6,5x150 mm	5

empty
display



1293BX/DVD 1 012930754

1293BX/DA

wall-mounted display with 90 screwdrivers



495x260x332 mm

display
with assortment



1293BX/DA 1 012930701

		n.
● 1290	3x75 - 3,5x100 - 4x100 - 4x125	7
	5,5x100 - 5,5x150 mm	6
	6,5x150 mm	3
	8x150 mm	2
	10x200 mm	2
● 1290N	4x30 - 6,5x30 mm	3
⊕ 1292	PH0x60 - PH1x80 mm	7
	PH2x100 mm	6
	PH3x150 mm	5
⊕ 1292N	PH1x30 - PH2x30 mm	3

empty
display



1293BX/DVA 1 012930751

1293BX/DC

wall-mounted display with 80 screwdrivers



495x260x332 mm

display
with assortment



1293BX/DC 1 012930703

		n.
⊕ 1292	PH0x60 - PH0x100 - PH1x80	7
	PH1x120 - PH1x150 mm	6
	PH2x100 - PH2x150 mm	5
	PH3x150 - PH4x200 mm	6
	PH3x175 mm	5
⊕ 1292N	PH1x30 - PH2x30 mm	6
⊕ 1292E	PH2x150 mm	6

empty
display



1293BX/DVC 1 012930753

1293BX/DE

wall-mounted display with 42 screwdrivers



330x260x332 mm

display
with assortment



1293BX/DE 1 012930705

		n.
⊕ 1299PZ	PZ0x60 - PZ1x80 mm	7
	PZ2x100 mm	6
	PZ3x150 - PZ4x200 mm	5
⊕ 1299N/PZ	PZ1x30 - PZ2x30 mm	6

empty
display



1293BX/DVE 1 012930755

1293BX/DF

wall-mounted display with 59 screwdrivers



330x260x332 mm

display
with assortment

1 012930706

	n.
1297TX T6 - T8 - T10 - T15 - T20 - T25	7
T27 - T30	6
T40	5

empty
display

1293BX/DVF

1 012930756

1293BX/E159

counter display with 159 screwdrivers



620x320x450 mm

display

with assortment

1 012930120

	n.
1290 2,5x50 - 2,5x75 mm	4
3x75 - 3,5x100 - 3,5x125 - 4x75	8
4x100 - 4x125 mm	
5,5x100 - 5,5x150 - 6,5x100 - 6,5x150 mm	7
8x200 - 10x200 mm	3
1290N 4x30 - 6,5x30 mm	3
1292 PH0x60 - PH0x100 mm	8
PH1x80 - PH1x120 - PH1x150	7
PH2x100 - PH2x150 mm	
PH3x150 mm	6
1292N PH1x30 - PH2x30 mm	3

empty
display

1293BX/EV159

1 012930121

C60

wall display, empty



500x520x2000 mm

C60

1 060000020

C61

wall display, empty



1000x520x2000 mm

C61

1 060010020

accessories

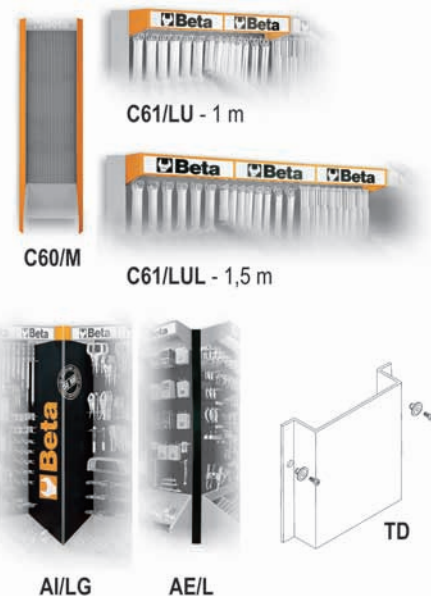

	n.
C60/M	1 060000030
C61/LU	1 060010102
C61/LUL	1 060010103
AE/L	1 060040501
AI/LG	1 060040502
TD	1 088880080

Beta



C68

Beta wall display, empty

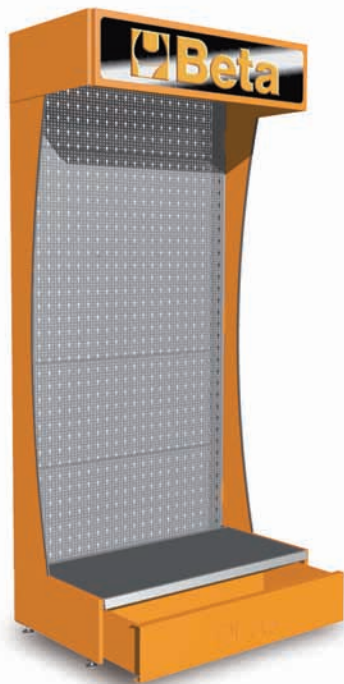

1000x560x2200 mm

C68/1	1 m	1	068000001
C68/2	2 m	1	068000002
C68/3	3 m	1	068000003
C68/4	4 m	1	068000004
C68/5	5 m	1	068000005
C68/6	6 m	1	068000006
C68/7	7 m	1	068000007
C68/8	8 m	1	068000008
C68/9	9 m	1	068000009
C68/10	10 m	1	068000010

C88 R/1

Robur wall display, empty



1000x560x2200 mm

C88 R/1	1	088000001
---------	---	-----------

6800 VE

showcase for wall displays C68 and C68 R/1



6800 VE/1	1 m	1	068000401
6800 VE/2	2 m	1	068000402
6800 VE/3	3 m	1	068000403
6800 VE/4	4 m	1	068000404
6800 VE/5	5 m	1	068000405

ACCESSORIES



6800 AE	1	068000145
6800 AI	1	068000140
6800 AD/P	1	068000143



6800 CB/100	1	068000104
6800 FB/100	1	068000109
6800 FO/100	1	068000108
6800 PL	1	068000137
6800 RP/100	1	068000150
6800 GR/37	1	068000159

C68 G

"gondola" display



1000x1120x1600 mm

C68 G/1	1 m	1	068000051
C68 G/2	2 m	1	068000052
C68 G/3	3 m	1	068000053
C68 G/4	4 m	1	068000054



6888

hooks for displays C60 - C61 - C68 - C88



6888 S1	10	068880011
6888 S2	10	068880012
6888 D1	5	068880021
6888 D2	5	068880022
6888 D4	5	068880024
6888 D5	5	068880025
6888 T1	5	068880031
6888 T2	5	068880032
6888 CT	1	068880044

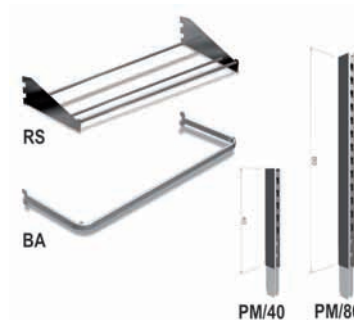

6800 BA	1	068000130
6800 RS	1	068000135
6800 PM/40	1	068000171
6800 PM/80	1	068000172



6600 M/10

assortment of 178 tools,
with hooks without panel

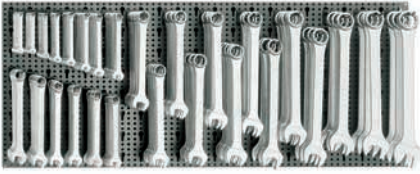

6600 M/10



6600 M/30

assortment of 18 tools,
with hooks without panel



6600 M/30



6600 M/47

assortment of 65 tools,
with hooks without panel



6600 M/47



6600 M/15

assortment of 118 tools,
with hooks without panel

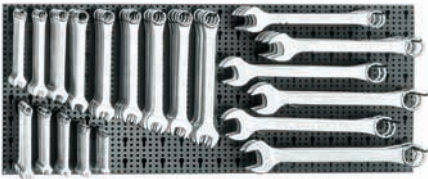

6600 M/15



6600 M/37

assortment of 107 tools,
with hooks without panel



6600 M/37

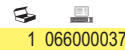

6600 M/50

assortment of 257 tools,
with hooks without panel



6600 M/50



6600 M/21

assortment of 127 tools,
with hooks without panel

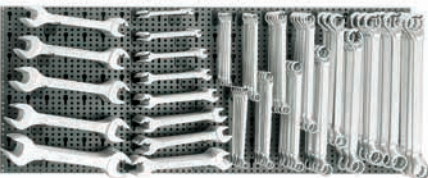

6600 M/21



6600 M/39

assortment of 77 tools,
with hooks without panel



6600 M/39



6600 M/54

assortment of 176 tools,
with hooks without panel



6600 M/54



6600 M/27

assortment of 25 tools,
with hooks without panel



6600 M/27



6600 M/40

assortment of 100 tools,
with hooks without panel



6600 M/40



6600 M/55

assortment of 150 tools,
with hooks without panel



6600 M/55



6600 M/60

assortment of 118 tools,
with hooks without panel

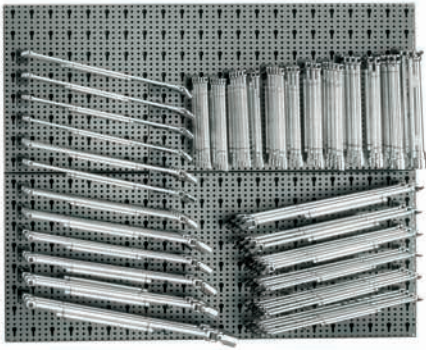

6600 M/60 1 066000060

6600 M/64

assortment of 104 tools,
with hooks without panel



6600 M/64 1 066000064

6600 M/67

assortment of 80 tools,
with hooks without panel



6600 M/67 1 066000067

6600 M/70

assortment of 107 tools,
with hooks without panel



6600 M/70 1 066000070

6600 M/112

assortment of 329 tools,
with hooks without panel



6600 M/112 1 066000112

6600 M/116

assortment of 306 tools,
with hooks without panel



6600 M/116 1 066000116

6600 M/120

assortment of 163 tools,
with hooks without panel



6600 M/120 1 066000120

6600 M/125

assortment of 133 tools,
with hooks without panel

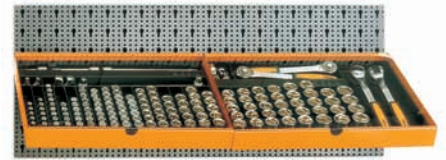

6600 M/125 1 066000125

6600 M/131

assortment of 92 tools,
with hooks without panel



6600 M/131 1 066000131

6600 M/152

assortment of 12 tools,
with hooks without panel

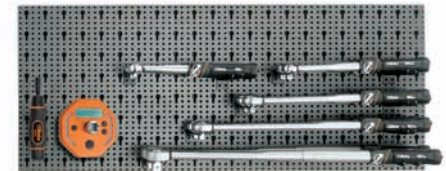

6600 M/152 1 066000152

6600 M/163

assortment of 30 tools,
with hooks without panel

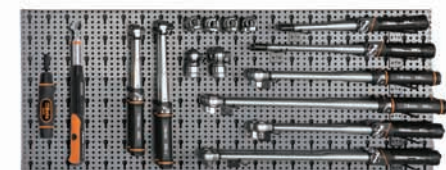

6600 M/163 1 066000163



6600 M/171

assortment of 13 tools,
with hooks without panel



6600 M/171



6600 M/235

assortment of 31 tools,
with hooks without panel



6600 M/235



6600 M/250

assortment of 32 tools,
with hooks without panel



6600 M/250



6600 M/216

assortment of 77 tools,
with hooks without panel

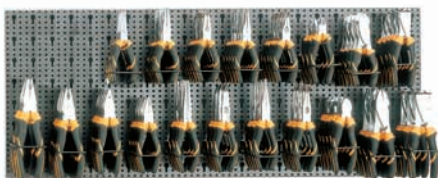

6600 M/216



6600 M/240

assortment of 47 tools,
with hooks without panel



6600 M/240



6600 M/251

assortment of 26 tools,
with hooks without panel



6600 M/251



6600 M/221

assortment of 77 tools,
with hooks without panel

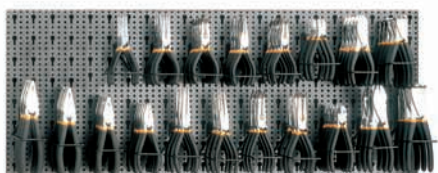

6600 M/221



6600 M/245

assortment of 91 tools,
with hooks without panel



6600 M/245



6600 M/310

assortment of 169 tools,
with hooks without panel



6600 M/310



6600 M/230

assortment of 78 tools,
with hooks without panel



6600 M/230



6600 M/246

assortment of 86 tools,
with hooks without panel



6600 M/246



6600 M/315

assortment of 149 tools,
with hooks without panel

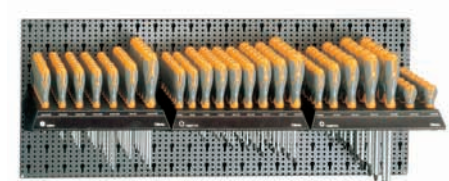



6600 M/315

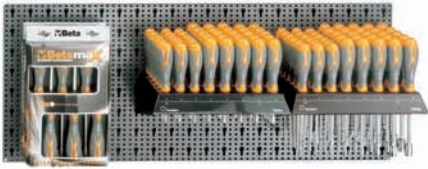

6600 M/320

assortment of 98 tools,
with hooks without panel



6600 M/320   1 066000320

6600 M/370

assortment of 162 tools,
with hooks without panel

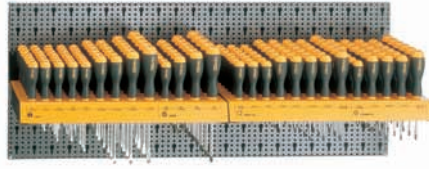

6600 M/370   1 066000370

6600 M/421

assortment of 18 tools,
with hooks without panel



6600 M/421   1 066000421

6600 M/326

assortment of 155 tools,
with hooks without panel





6600 M/326   1 066000326

6600 M/376

assortment of 73 tools,
with hooks without panel





6600 M/376   1 066000376

6600 M/425

assortment of 24 tools,
with hooks without panel



6600 M/425   1 066000425

6600 M/327

assortment of 101 tools,
with hooks without panel

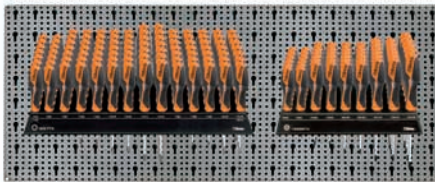



6600 M/327   1 066000327

6600 M/417

assortment of 43 tools, with hooks without
panel





6600 M/417   1 066000417

6600 M/430

assortment of 29 tools,
with hooks without panel



6600 M/430   1 066000430

6600 M/330

assortment of 110 tools,
with hooks without panel

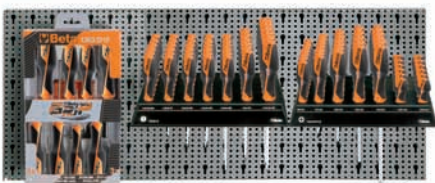

6600 M/330   1 066000330

6600 M/418

assortment of 35 tools,
with hooks without panel

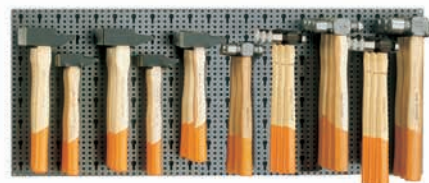



6600 M/418   1 066000418

6600 M/440

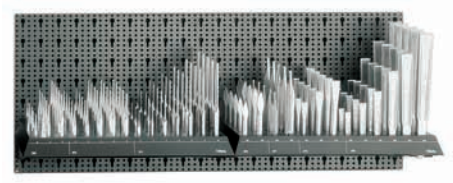
assortment of 140 tools,
with hooks without panel



6600 M/440   1 066000440

6600 M/453

assortment of 37 tools,
with hooks without panel



6600 M/453



1 066000453

6600 M/480

assortment of 18 tools,
with hooks without panel



6600 M/480



1 066000480

6600 M/518

assortment of 19 tools,
with hooks without panel



6600 M/518



1 066000518

6600 M/463

assortment of 36 tools,
with hooks without panel



6600 M/463



1 066000463

6600 M/485

assortment of 12 tools,
with hooks without panel



6600 M/485



1 066000485

6600 M/524

assortment of 73 tools,
with hooks without panel



6600 M/524



1 066000524

6600 M/471

assortment of 25 tools,
with hooks without panel



6600 M/471



1 066000471

6600 M/510

assortment of 16 tools,
with hooks without panel



6600 M/510



1 066000510

6600 M/531

assortment of 24 tools,
with hooks without panel



6600 M/531



1 066000531

6600 M/477

assortment of 34 tools,
with hooks without panel



6600 M/477



1 066000477

6600 M/515

assortment of 3 tools,
with hooks without panel



6600 M/515



1 066000515

6600 M/541

assortment of 53 tools,
with hooks without panel



6600 M/541



1 066000541

6600 M/550

assortment of 442 tools,
with hooks without panel



6600 M/550   1 066000550

6600 M/622

assortment of 94 tools,
with hooks without panel



6600 M/622   1 066000622

6600 M/713

assortment of 63 tools,
with hooks without panel





6600 M/713   1 066000713

6600 M/561

assortment of 60 tools,
with hooks without panel





6600 M/561   1 066000561

6600 M/632

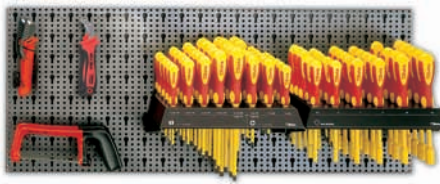
assortment of 76 tools,
with hooks without panel



6600 M/632   1 066000632

6600 M/723

assortment of 12 tools,
with hooks without panel



6600 M/723   1 066000723

6600 M/582

assortment of 21 tools,
with hooks without panel





6600 M/582   1 066000582

6600 M/650

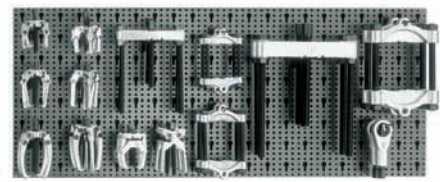
assortment of 28 tools,
with hooks without panel



6600 M/650   1 066000650

6600 M/818

assortment of 102 tools,
with hooks without panel



6600 M/818   1 066000818

6600 M/615

assortment of 67 tools,
with hooks without panel





6600 M/615   1 066000615

6600 M/657

assortment of 17 tools,
with hooks without panel



6600 M/657   1 066000657



6600 M/823

assortment of 39 tools,
with hooks without panel



6600 M/823



6600 M/829

assortment of 33 tools,
with hooks without panel



6600 M/829



8600 R/10

assortment of 672 wire rope accessories,
with hooks without panel

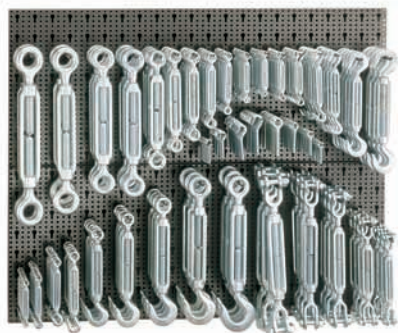

8600 R/10



8600 R/111

assortment of 1887 wire rope accessories,
with hooks without panel



8600 R/111



8600 R/221

assortment of 53 wire rope accessories,
with hooks without panel



8600 R/221



8600 R/410

assortment of 585 wire rope accessories,
STAINLESS STEEL
with hooks without panel

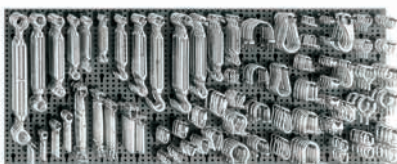

8600 R/410



8600 E/R

assortment of 3197 wire rope accessories,
with hooks without display



8600 E/R



6600 E/A10

assortment of 802 tools,
with hooks without display



6600 E/A10



6600 E/A20

assortment of 701 tools,
with hooks without display

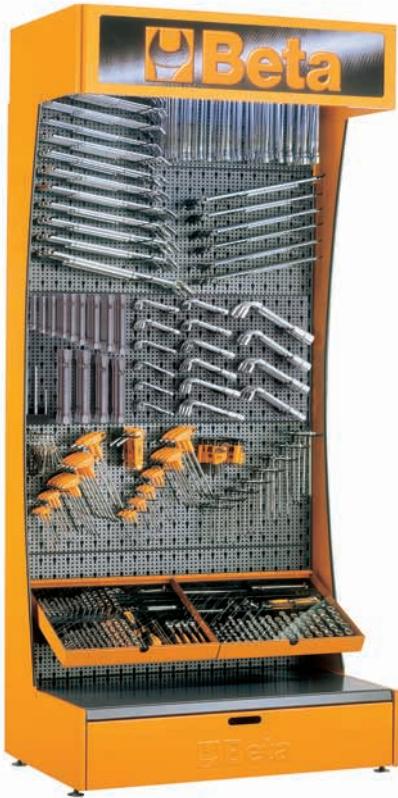

6600 E/A20

1 066000907

6600 E/B10

assortment of 651 tools,
with hooks without display



6600 E/B10

1 066000911

6600 E/C10

assortment of 300 tools,
with hooks without display



6600 E/C10

1 066000932

6600 E/A30

assortment of 753 tools,
with hooks without display



6600 E/A30

1 066000908

6600 E/B20

assortment of 601 tools,
with hooks without display



6600 E/B20

1 066000922

6600 E/D10

assortment of 271 tools,
with hooks without display



6600 E/D10

1 066000939

6600 E/E10

assortment of 128 tools,
with hooks without display



6600 E/E10



1 066000948

6600 E/K10

assortment of 610 tools,
with hooks without display



6600 E/K10



1 066000958

6600 E/P10

assortment of 69 tools,
with hooks without display

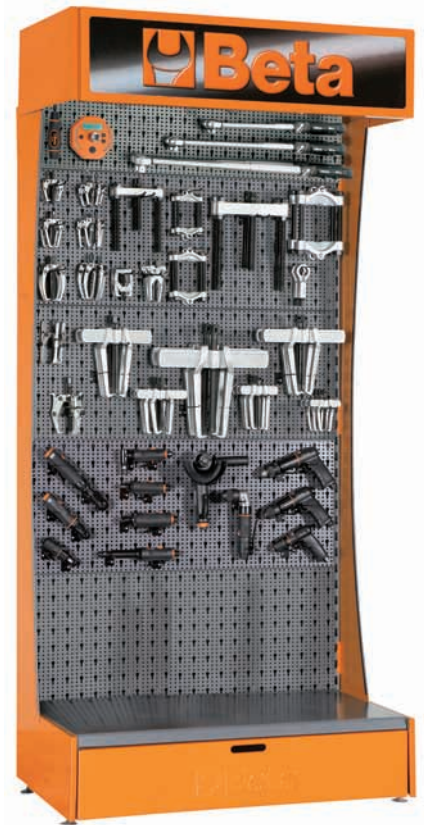

6600 E/P10

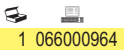

1 066000964

6600 E/G10

assortment of 121 tools,
with hooks without display

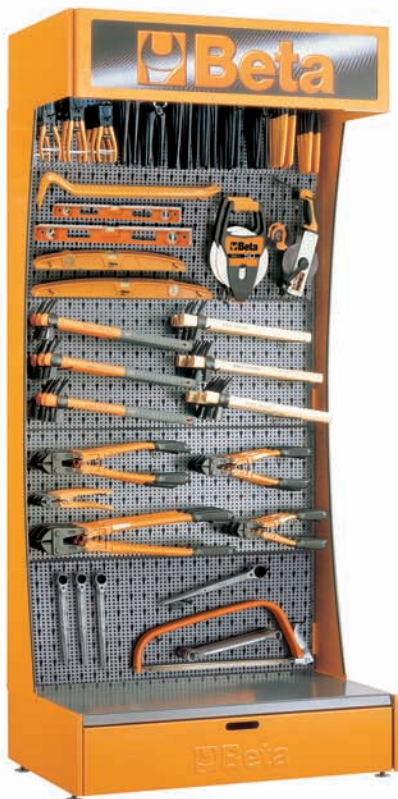

6600 E/G10



1 066000949

6600 E/K20

assortment of 499 tools,
with hooks without display



6600 E/K20



1 066000959



SAFETY FOOTWEAR

Over the years the safety footwear line has gained the most demanding professionals' confidence and preference. These products have been proving so successful as to result in a regularly upgraded and expanded range.



To make it easier to identify both the specifications and the details that suit you best, read the section and icons below.



Penetration proof midsole or inset



Steel, aluminium or plastic toe cap



Antistatic footwear



Energy absorption in the heel region



Oil, hydrocarbon and solvent proof outsole



Antislip outsole



Flexing resistance >60,000



Outsole resistant to hot contact (300 °C/min.)

WARNINGS

PRELIMINARY CHECKS AND USE

Before using the shoes, visually check their general state – that is, the seams, the sole and the closures –; also make sure that the shoes match all the specifications on the label, and, above all, that they are provided

with steel toes and penetration proof steel midsoles.

MISUSE

Prolonged and/or repeated use:
• in contact with organic agents, herbicides,

pesticides and highly concentrated acids
• at very low or very high temperatures (below -10 °C and over +70 °C)
• fully dipped into water, mud, mortar and alike is not recommended.

7200NKK

full-grain leather shoe,
highly breathable



EU	UK	1	2
35	2,5	1	072000135
36	3,5	1	072000136
37	4,5	1	072000137
38	5	1	072000138
39	6	1	072000139
40	6,5	1	072000140
41	7	1	072000141
42	8	1	072000142
43	9	1	072000143
44	10	1	072000144
45	10,5	1	072000145
46	11	1	072000146
47	12	1	072000147
48	13	1	072000148



CE

EN 20345 S3



7201NKK

full-grain leather ankle shoe,
highly breathable



EU	UK	1	2
35	2,5	1	072010135
36	3,5	1	072010136
37	4,5	1	072010137
38	5	1	072010138
39	6	1	072010139
40	6,5	1	072010140
41	7	1	072010141
42	8	1	072010142
43	9	1	072010143
44	10	1	072010144
45	10,5	1	072010145
46	11	1	072010146
47	12	1	072010147
48	13	1	072010148



CE

EN 20345 S3



7201NA

leather ankle shoe, waterproof,
quick opening

- Steel toe cap
- Elastic steel penetration proof insole



EU	UK	1	2
38	5	1	072010338
39	6	1	072010339
40	6,5	1	072010340
41	7	1	072010341
42	8	1	072010342
43	9	1	072010343
44	10	1	072010344
45	10,5	1	072010345
46	11	1	072010346
47	12	1	072010347
48	13	1	072010348



CE

EN 20345 S3



7203NA

leather shoe, highly breathable

- Steel toe cap
- Elastic steel penetration proof insole



EU	UK	1	2
38	5	1	072030338
39	6	1	072030339
40	6,5	1	072030340
41	7	1	072030341
42	8	1	072030342
43	9	1	072030343
44	10	1	072030344
45	10,5	1	072030345
46	11	1	072030346
47	12	1	072030347
48	13	1	072030348



CE

EN 20345 S1P



7203NB

leather shoe, waterproof

- Steel toe cap
- Elastic steel penetration proof insole



EU	UK		
38	5	1	072030438
39	6	1	072030439
40	6,5	1	072030440
41	7	1	072030441
42	8	1	072030442
43	9	1	072030443
44	10	1	072030444
45	10,5	1	072030445
46	11	1	072030446
47	12	1	072030447
48	13	1	072030448



CE

EN 20345 S3

7204NA

leather ankle shoe, highly breathable

- Steel toe cap
- Elastic steel penetration proof insole



EU	UK		
38	5	1	072040338
39	6	1	072040339
40	6,5	1	072040340
41	7	1	072040341
42	8	1	072040342
43	9	1	072040343
44	10	1	072040344
45	10,5	1	072040345
46	11	1	072040346
47	12	1	072040347
48	13	1	072040348



CE

EN 20345 S1P

7205NPK

full-grain leather shoe,
highly breathable,
with polyurethane toe cap and wide body



EU	UK		
38	5	1	072050138
39	6	1	072050139
40	6,5	1	072050140
41	7	1	072050141
42	8	1	072050142
43	9	1	072050143
44	10	1	072050144
45	10,5	1	072050145
46	11	1	072050146
47	12	1	072050147
48	13	1	072050148



CE

EN 20345 S3

7206NPK

full-grain leather ankle shoe,
highly breathable,
with polyurethane toe cap and wide body



EU	UK		
38	5	1	072060138
39	6	1	072060139
40	6,5	1	072060140
41	7	1	072060141
42	8	1	072060142
43	9	1	072060143
44	10	1	072060144
45	10,5	1	072060145
46	11	1	072060146
47	12	1	072060147
48	13	1	072060148



CE

EN 20345 S3

7207R

leather shoe,
without penetration proof midsole,
with rubber outsole



CE

EN 20345 S1 HRO



EU	UK		
39	6	1	072070039
40	6,5	1	072070040
41	7	1	072070041
42	8	1	072070042
43	9	1	072070043
44	10	1	072070044
45	10,5	1	072070045
46	11	1	072070046
47	12	1	072070047

7207RK

full-grain leather shoe,
with rubber outsole



CE

EN 20345 S3 HRO



EU	UK		
39	6	1	072070139
40	6,5	1	072070140
41	7	1	072070141
42	8	1	072070142
43	9	1	072070143
44	10	1	072070144
45	10,5	1	072070145
46	11	1	072070146
47	12	1	072070147

7208R

leather ankle shoe,
without penetration proof midsole,
with rubber outsole



CE

EN 20345 S1 HRO



EU	UK		
39	6	1	072080039
40	6,5	1	072080040
41	7	1	072080041
42	8	1	072080042
43	9	1	072080043
44	10	1	072080044
45	10,5	1	072080045
46	11	1	072080046
47	12	1	072080047

7208RK

full-grain leather ankle shoe,
with rubber outsole



CE

EN 20345 S3 HRO



EU	UK		
39	6	1	072080139
40	6,5	1	072080140
41	7	1	072080141
42	8	1	072080142
43	9	1	072080143
44	10	1	072080144
45	10,5	1	072080145
46	11	1	072080146
47	12	1	072080147

7210NA

soft suede shoe, perforated

- Steel toe cap
- Elastic steel penetration proof insole



EU	UK	1	2
35	2,5	1	072100235
36	3,5	1	072100236
37	4,5	1	072100237
38	5	1	072100238
39	6	1	072100239
40	6,5	1	072100240
41	7	1	072100241
42	8	1	072100242
43	9	1	072100243
44	10	1	072100244
45	10,5	1	072100245
46	11	1	072100246
47	12	1	072100247
48	13	1	072100248



CE

EN 20345 S1P

7211NA

soft suede shoe,
without penetration proof insole

- Steel toe cap
- Without penetration proof insole



EU	UK	1	2
35	2,5	1	072110235
36	3,5	1	072110236
37	4,5	1	072110237
38	5	1	072110238
39	6	1	072110239
40	6,5	1	072110240
41	7	1	072110241
42	8	1	072110242
43	9	1	072110243
44	10	1	072110244
45	10,5	1	072110245
46	11	1	072110246
47	12	1	072110247
48	13	1	072110248



CE

EN 20345 S1

7216NA

soft suede sandal,
with strap closure

- Steel toe cap
- Elastic steel penetration proof insole



EU	UK	1	2
35	2,5	1	072160235
36	3,5	1	072160236
37	4,5	1	072160237
38	5	1	072160238
39	6	1	072160239
40	6,5	1	072160240
41	7	1	072160241
42	8	1	072160242
43	9	1	072160243
44	10	1	072160244
45	10,5	1	072160245
46	11	1	072160246
47	12	1	072160247



CE

EN 20345 S1P

7225WK

Lorica moccasin,
waterproof,
without penetration proof midsole



EU	UK	1	2
36	3,5	1	072250036
37	4,5	1	072250037
38	5	1	072250038
39	6	1	072250039
40	6,5	1	072250040
41	7	1	072250041
42	8	1	072250042
43	9	1	072250043
44	10	1	072250044
45	10,5	1	072250045
46	11	1	072250046
47	12	1	072250047
48	13	1	072250048



CE

EN 20345 S2

7226WK

microfiber shoe,
waterproof,
without penetration proof midsole



EU	UK		
36	3,5	1	072260036
37	4,5	1	072260037
38	5	1	072260038
39	6	1	072260039
40	6,5	1	072260040
41	7	1	072260041
42	8	1	072260042
43	9	1	072260043
44	10	1	072260044
45	10,5	1	072260045
46	11	1	072260046
47	12	1	072260047
48	13	1	072260048



CE

EN 20345 S1



7227WK

microfiber shoe,
waterproof,
without penetration proof midsole



EU	UK		
36	3,5	1	072270036
37	4,5	1	072270037
38	5	1	072270038
39	6	1	072270039
40	6,5	1	072270040
41	7	1	072270041
42	8	1	072270042
43	9	1	072270043
44	10	1	072270044
45	10,5	1	072270045
46	11	1	072270046
47	12	1	072270047
48	13	1	072270048



CE

EN 20345 S1



7228NWK

microfiber shoe,
waterproof,
without penetration proof midsole



EU	UK		
36	3,5	1	072280036
37	4,5	1	072280037
38	5	1	072280038
39	6	1	072280039
40	6,5	1	072280040
41	7	1	072280041
42	8	1	072280042
43	9	1	072280043
44	10	1	072280044
45	10,5	1	072280045
46	11	1	072280046
47	12	1	072280047
48	13	1	072280048



CE

EN 20345 S2



7229WK

microfiber shoe,
waterproof,
without penetration proof midsole



EU	UK		
36	3,5	1	072290036
37	4,5	1	072290037
38	5	1	072290038
39	6	1	072290039
40	6,5	1	072290040
41	7	1	072290041
42	8	1	072290042
43	9	1	072290043
44	10	1	072290044
45	10,5	1	072290045
46	11	1	072290046
47	12	1	072290047
48	13	1	072290048



CE

EN 20345 S2



7240B

leather shoe, without penetration proof insole

- Steel toe cap
- Without penetration proof insole



EU	UK	1	072400235
35	2,5	1	072400235
36	3,5	1	072400236
37	4,5	1	072400237
38	5	1	072400238
39	6	1	072400239
40	6,5	1	072400240
41	7	1	072400241
42	8	1	072400242
43	9	1	072400243
44	10	1	072400244
45	10,5	1	072400245
46	11	1	072400246
47	12	1	072400247
48	13	1	072400248



CE

EN 20345 S1

7241B

leather shoe, with penetration proof insole

- Steel toe cap
- Elastic steel penetration proof insole



EU	UK	1	072410235
35	2,5	1	072410235
36	3,5	1	072410236
37	4,5	1	072410237
38	5	1	072410238
39	6	1	072410239
40	6,5	1	072410240
41	7	1	072410241
42	8	1	072410242
43	9	1	072410243
44	10	1	072410244
45	10,5	1	072410245
46	11	1	072410246
47	12	1	072410247
48	13	1	072410248



CE

EN 20345 S1P

7242B

leather ankle shoe,
without penetration proof insole

- Steel toe cap
- Without penetration proof insole



EU	UK	1	072420235
35	2,5	1	072420235
36	3,5	1	072420236
37	4,5	1	072420237
38	5	1	072420238
39	6	1	072420239
40	6,5	1	072420240
41	7	1	072420241
42	8	1	072420242
43	9	1	072420243
44	10	1	072420244
45	10,5	1	072420245
46	11	1	072420246
47	12	1	072420247
48	13	1	072420248



CE

EN 20345 S1

7243B

leather ankle shoe, with penetration proof insole

- Steel toe cap
- Elastic steel penetration proof insole



EU	UK	1	072430235
35	2,5	1	072430235
36	3,5	1	072430236
37	4,5	1	072430237
38	5	1	072430238
39	6	1	072430239
40	6,5	1	072430240
41	7	1	072430241
42	8	1	072430242
43	9	1	072430243
44	10	1	072430244
45	10,5	1	072430245
46	11	1	072430246
47	12	1	072430247
48	13	1	072430248



CE

EN 20345 S1P

7245CM

ankle shoe, with front protection and strap closure



EU	UK		
38	5	1	072450138
39	6	1	072450139
40	6,5	1	072450140
41	7	1	072450141
42	8	1	072450142
43	9	1	072450143
44	10	1	072450144
45	10,5	1	072450145
46	11	1	072450146
47	12	1	072450147
48	13	1	072450148

CE



EN 20345 S1P

7246B

suede shoe, perforated



EU	UK		
35	2,5	1	072460235
36	3,5	1	072460236
37	4,5	1	072460237
38	5	1	072460238
39	6	1	072460239
40	6,5	1	072460240
41	7	1	072460241
42	8	1	072460242
43	9	1	072460243
44	10	1	072460244
45	10,5	1	072460245
46	11	1	072460246
47	12	1	072460247
48	13	1	072460248

CE



EN 20345 S1P

- Steel toe cap
- Elastic steel penetration proof insole

7247B

leather sandal, perforated



EU	UK		
35	2,5	1	072470235
36	3,5	1	072470236
37	4,5	1	072470237
38	5	1	072470238
39	6	1	072470239
40	6,5	1	072470240
41	7	1	072470241
42	8	1	072470242
43	9	1	072470243
44	10	1	072470244
45	10,5	1	072470245
46	11	1	072470246
47	12	1	072470247
48	13	1	072470248

CE



EN 20345 S1P

- Steel toe cap
- Elastic steel penetration proof insole

7250NK

suede shoe, with airmet insets



EU	UK		
38	5	1	072500138
39	6	1	072500139
40	6,5	1	072500140
41	7	1	072500141
42	8	1	072500142
43	9	1	072500143
44	10	1	072500144
45	10,5	1	072500145
46	11	1	072500146
47	12	1	072500147

CE



EN 20345 S1P

7251NK

suede ankle shoe, with airtet insets



EU	UK		
38	5	1	072510138
39	6	1	072510139
40	6,5	1	072510140
41	7	1	072510141
42	8	1	072510142
43	9	1	072510143
44	10	1	072510144
45	10,5	1	072510145
46	11	1	072510146
47	12	1	072510147



CE

EN 20345 S1P

7254NA

suede shoe, waterproof, with nylon insets



EU	UK		
38	5	1	072540138
39	6	1	072540139
40	6,5	1	072540140
41	7	1	072540141
42	8	1	072540142
43	9	1	072540143
44	10	1	072540144
45	10,5	1	072540145
46	11	1	072540146
47	12	1	072540147



CE

EN 20345 S3

7255NA

suede ankle shoe, waterproof, with nylon insets



EU	UK		
38	5	1	072550138
39	6	1	072550139
40	6,5	1	072550140
41	7	1	072550141
42	8	1	072550142
43	9	1	072550143
44	10	1	072550144
45	10,5	1	072550145
46	11	1	072550146
47	12	1	072550147



CE

EN 20345 S3

7256NA

suede shoe, waterproof, with nylon insets



EU	UK		
38	5	1	072560138
39	6	1	072560139
40	6,5	1	072560140
41	7	1	072560141
42	8	1	072560142
43	9	1	072560143
44	10	1	072560144
45	10,5	1	072560145
46	11	1	072560146
47	12	1	072560147



CE

EN 20345 S3

7257NA

suede ankle shoe, waterproof, with nylon insets



EU	UK	1	2
38	5	1	072570138
39	6	1	072570139
40	6,5	1	072570140
41	7	1	072570141
42	8	1	072570142
43	9	1	072570143
44	10	1	072570144
45	10,5	1	072570145
46	11	1	072570146
47	12	1	072570147



CE

EN 20345 S3

7263NK

suede shoe, with mesh insets, waterproof



EU	UK	1	2
38	5	1	072630038
39	6	1	072630039
40	6,5	1	072630040
41	7	1	072630041
42	8	1	072630042
43	9	1	072630043
44	10	1	072630044
45	10,5	1	072630045
46	11	1	072630046
47	12	1	072630047



CE

EN 20345 S3

7264NK

suede ankle shoe, with mesh insets, waterproof



EU	UK	1	2
38	5	1	072640038
39	6	1	072640039
40	6,5	1	072640040
41	7	1	072640041
42	8	1	072640042
43	9	1	072640043
44	10	1	072640044
45	10,5	1	072640045
46	11	1	072640046
47	12	1	072640047



CE

EN 20345 S3

7290AKK

full-grain leather shoe, waterproof, highly breathable



EU	UK	1	2
38	5	1	072900238
39	6	1	072900239
40	6,5	1	072900240
41	7	1	072900241
42	8	1	072900242
43	9	1	072900243
44	10	1	072900244
45	10,5	1	072900245
46	11	1	072900246
47	12	1	072900247
48	13	1	072900248



CE

EN 20345 S3

7291AKK

full-grain leather ankle shoe, waterproof, highly breathable



EU	UK		
38	5	1	072910238
39	6	1	072910239
40	6,5	1	072910240
41	7	1	072910241
42	8	1	072910242
43	9	1	072910243
44	10	1	072910244
45	10,5	1	072910245
46	11	1	072910246
47	12	1	072910247
48	13	1	072910248

CE



EN 20345 S3

7293NKK

greased Nubuck shoe, with dynamic control system and durable VIBRAM® rubber outsole



EU	UK		
38	5	1	072930138
39	6	1	072930139
40	6,5	1	072930140
41	7	1	072930141
42	8	1	072930142
43	9	1	072930143
44	10	1	072930144
45	10,5	1	072930145
46	11	1	072930146
47	12	1	072930147
48	13	1	072930148

CE



EN 20345 S3 HRO

7293TKK

greased Nubuck shoe, with Thinsulate™ membrane, dynamic control system and durable VIBRAM® rubber outsole



EU	UK		
38	5	1	072930238
39	6	1	072930239
40	6,5	1	072930240
41	7	1	072930241
42	8	1	072930242
43	9	1	072930243
44	10	1	072930244
45	10,5	1	072930245
46	11	1	072930246
47	12	1	072930247
48	13	1	072930248

CE



EN 20345 S3 HRO

7293RK

greased Nubuck shoe, with torsion control system and durable rubber outsole



EU	UK		
39	6	1	072930339
40	6,5	1	072930340
41	7	1	072930341
42	8	1	072930342
43	9	1	072930343
44	10	1	072930344
45	10,5	1	072930345
46	11	1	072930346
47	12	1	072930347

CE



EN 20345 S3 HRO

7294NKK

greased Nubuck ankle shoe,
with dynamic control system
and durable VIBRAM® rubber outsole



EU	UK		
38	5	1	072940138
39	6	1	072940139
40	6,5	1	072940140
41	7	1	072940141
42	8	1	072940142
43	9	1	072940143
44	10	1	072940144
45	10,5	1	072940145
46	11	1	072940146
47	12	1	072940147
48	13	1	072940148

CE



EN 20345 S3 HRO

7294TKK

greased Nubuck ankle shoe,
with Thinsulate™ membrane, dynamic control system
and durable VIBRAM® rubber outsole



EU	UK		
38	5	1	072940238
39	6	1	072940239
40	6,5	1	072940240
41	7	1	072940241
42	8	1	072940242
43	9	1	072940243
44	10	1	072940244
45	10,5	1	072940245
46	11	1	072940246
47	12	1	072940247
48	13	1	072940248

CE



EN 20345 S3 HRO

7294RK

greased Nubuck ankle shoe,
with torsion control system and durable rubber outsole



EU	UK		
39	6	1	072940339
40	6,5	1	072940340
41	7	1	072940341
42	8	1	072940342
43	9	1	072940343
44	10	1	072940344
45	10,5	1	072940345
46	11	1	072940346
47	12	1	072940347

CE



EN 20345 S3 HRO

7300AKK

full-grain leather shoe, highly breathable



EU	UK		
36	3,5	1	073000136
37	4,5	1	073000137
38	5	1	073000138
39	6	1	073000139
40	6,5	1	073000140
41	7	1	073000141
42	8	1	073000142
43	9	1	073000143
44	10	1	073000144
45	10,5	1	073000145
46	11	1	073000146
47	12	1	073000147
48	13	1	073000148

CE



EN 20345 S3

7300BKK

full-grain leather shoe, highly breathable



EU	UK	1	073000236
36	3,5	1	073000236
37	4,5	1	073000237
38	5	1	073000238
39	6	1	073000239
40	6,5	1	073000240
41	7	1	073000241
42	8	1	073000242
43	9	1	073000243
44	10	1	073000244
45	10,5	1	073000245
46	11	1	073000246
47	12	1	073000247
48	13	1	073000248



CE

EN 20345 S3

7300CKK

denim shoe with suede insets



EU	UK	1	073000336
36	3,5	1	073000336
37	4,5	1	073000337
38	5	1	073000338
39	6	1	073000339
40	6,5	1	073000340
41	7	1	073000341
42	8	1	073000342
43	9	1	073000343
44	10	1	073000344
45	10,5	1	073000345
46	11	1	073000346
47	12	1	073000347
48	13	1	073000348



CE

EN 20345 S1P

7302N

perforated soft suede shoe, "free time" style, without steel toe and penetration proof midsole



EU	UK	1	073020136
36	3,5	1	073020136
37	4,5	1	073020137
38	5	1	073020138
39	6	1	073020139
40	6,5	1	073020140
41	7	1	073020141
42	8	1	073020142
43	9	1	073020143
44	10	1	073020144
45	10,5	1	073020145
46	11	1	073020146
47	12	1	073020147
48	13	1	073020148



CE

EN 20347 O1

7302NKK

perforated soft suede shoe



EU	UK	1	073020236
36	3,5	1	073020236
37	4,5	1	073020237
38	5	1	073020238
39	6	1	073020239
40	6,5	1	073020240
41	7	1	073020241
42	8	1	073020242
43	9	1	073020243
44	10	1	073020244
45	10,5	1	073020245
46	11	1	073020246
47	12	1	073020247
48	13	1	073020248



CE

EN 20345 S1P

7303N

full-grain leather shoe,
"free time" style, without steel toe
and penetration proof midsole, highly breathable



EU	UK		
36	3,5	1	073030136
37	4,5	1	073030137
38	5	1	073030138
39	6	1	073030139
40	6,5	1	073030140
41	7	1	073030141
42	8	1	073030142
43	9	1	073030143
44	10	1	073030144
45	10,5	1	073030145
46	11	1	073030146
47	12	1	073030147
48	13	1	073030148

CE



EN 20347 O2

7304N

greased Nubuck shoe,
"free time" style, without steel toe
penetration proof midsole



EU	UK		
36	3,5	1	073040136
37	4,5	1	073040137
38	5	1	073040138
39	6	1	073040139
40	6,5	1	073040140
41	7	1	073040141
42	8	1	073040142
43	9	1	073040143
44	10	1	073040144
45	10,5	1	073040145
46	11	1	073040146
47	12	1	073040147
48	13	1	073040148

CE



EN 20347 O2

7310RKK

full-grain leather lace-up shoe, "welder style", rubber outsole

- Composite toe cap
- Composite fibre penetration proof insole



EU	UK		
38	5	1	073100138
39	6	1	073100139
40	6,5	1	073100140
41	7	1	073100141
42	8	1	073100142
43	9	1	073100143
44	10	1	073100144
45	10,5	1	073100145
46	11	1	073100146
47	12	1	073100147

CE



EN 20345 S3 HRO

 **Beta**



7311RK

leather shoe, "welder style",
with rubber outsole and quick opening buckle



EU	UK	Icon	Code
38	5		1 073110238
39	6		1 073110239
40	6,5		1 073110240
41	7		1 073110241
42	8		1 073110242
43	9		1 073110243
44	10		1 073110244
45	10,5		1 073110245
46	11		1 073110246
47	12		1 073110247



CE

EN 20345 S1P HRO

7313AK

"light" suede shoe,
with mesh insets and racing outsole



EU	UK	Icon	Code
36	3,5		1 073130036
37	4,5		1 073130037
38	5		1 073130038
39	6		1 073130039
40	6,5		1 073130040
41	7		1 073130041
42	8		1 073130042
43	9		1 073130043
44	10		1 073130044
45	10,5		1 073130045
46	11		1 073130046
47	12		1 073130047



CE

EN 20345 S1P

7313AK/B

"light" suede shoe, with mesh insets and racing outsole



EU	UK	Icon	Code
36	3,5		1 073130136
37	4,5		1 073130137
38	5		1 073130138
39	6		1 073130139
40	6,5		1 073130140
41	7		1 073130141
42	8		1 073130142
43	9		1 073130143
44	10		1 073130144
45	10,5		1 073130145
46	11		1 073130146
47	12		1 073130147



CE

EN 20345 S1P

7314AK

"light" suede shoe,
with racing outsole



EU	UK	Icon	Code
36	3,5		1 073140036
37	4,5		1 073140037
38	5		1 073140038
39	6		1 073140039
40	6,5		1 073140040
41	7		1 073140041
42	8		1 073140042
43	9		1 073140043
44	10		1 073140044
45	10,5		1 073140045
46	11		1 073140046
47	12		1 073140047



CE

EN 20345 S1P

7334AK

soft suede moccasin

- Aluminium toe cap
- Composite fibre penetration proof insole



EU	UK	Icon	Code
36	3,5		1 073340136
37	4,5		1 073340137
38	5		1 073340138
39	6		1 073340139
40	6,5		1 073340140
41	7		1 073340141
42	8		1 073340142
43	9		1 073340143
44	10		1 073340144
45	10,5		1 073340145
46	11		1 073340146
47	12		1 073340147

CE



EN 20345 S1P



7313AK/C

"light" full-grain leather shoe, mesh insets, racing outsole

- Aluminium toe cap
- Composite fibre penetration proof insole



EU	UK	Icon	Code
36	3,5		1 073130236
37	4,5		1 073130237
38	5		1 073130238
39	6		1 073130239
40	6,5		1 073130240
41	7		1 073130241
42	8		1 073130242
43	9		1 073130243
44	10		1 073130244
45	10,5		1 073130245
46	11		1 073130246
47	12		1 073130247

CE



EN 20345 S1P



7316AK/B

"light" soft full-grain leather shoe, perforated, racing outsole

- Aluminium toe cap
- Composite fibre penetration proof insole



EU	UK	Icon	Code
36	3,5		1 073160136
37	4,5		1 073160137
38	5		1 073160138
39	6		1 073160139
40	6,5		1 073160140
41	7		1 073160141
42	8		1 073160142
43	9		1 073160143
44	10		1 073160144
45	10,5		1 073160145
46	11		1 073160146
47	12		1 073160147

CE



EN 20345 S1P



Beta



7320AK

"light" suede shoe, waterproof, racing outsole



EU	UK	SKU
36	3,5	1 073200136
37	4,5	1 073200137
38	5	1 073200138
39	6	1 073200139
40	6,5	1 073200140
41	7	1 073200141
42	8	1 073200142
43	9	1 073200143
44	10	1 073200144
45	10,5	1 073200145
46	11	1 073200146
47	12	1 073200147

CE



EN 20345 S3



7323AK

"light" suede ankle shoe, waterproof, racing outsole



EU	UK	SKU
36	3,5	1 073230036
37	4,5	1 073230037
38	5	1 073230038
39	6	1 073230039
40	6,5	1 073230040
41	7	1 073230041
42	8	1 073230042
43	9	1 073230043
44	10	1 073230044
45	10,5	1 073230045
46	11	1 073230046
47	12	1 073230047

CE



EN 20345 S3



7315AK

"light" suede shoe, with racing outsole



EU	UK	SKU
36	3,5	1 073150036
37	4,5	1 073150037
38	5	1 073150038
39	6	1 073150039
40	6,5	1 073150040
41	7	1 073150041
42	8	1 073150042
43	9	1 073150043
44	10	1 073150044
45	10,5	1 073150045
46	11	1 073150046
47	12	1 073150047

CE



EN 20345 S1P



7324AK

"light" suede ankle shoe, racing outsole



EU	UK	SKU
36	3,5	1 073240036
37	4,5	1 073240037
38	5	1 073240038
39	6	1 073240039
40	6,5	1 073240040
41	7	1 073240041
42	8	1 073240042
43	9	1 073240043
44	10	1 073240044
45	10,5	1 073240045
46	11	1 073240046
47	12	1 073240047

CE



EN 20345 S1P



7316AK

"light" drummed full-grain leather shoe,
with racing outsole



EU	UK	Icon	Code
36	3,5		1 073160036
37	4,5		1 073160037
38	5		1 073160038
39	6		1 073160039
40	6,5		1 073160040
41	7		1 073160041
42	8		1 073160042
43	9		1 073160043
44	10		1 073160044
45	10,5		1 073160045
46	11		1 073160046
47	12		1 073160047



CE

EN 20345 S3

7325AK

"light" drummed full-grain leather shoe, waterproof, racing
outsole



EU	UK	Icon	Code
36	3,5		1 073250036
37	4,5		1 073250037
38	5		1 073250038
39	6		1 073250039
40	6,5		1 073250040
41	7		1 073250041
42	8		1 073250042
43	9		1 073250043
44	10		1 073250044
45	10,5		1 073250045
46	11		1 073250046
47	12		1 073250047



CE

EN 20345 S3

7318AK

"light" perforated suede shoe,
with racing outsole



EU	UK	Icon	Code
36	3,5		1 073180036
37	4,5		1 073180037
38	5		1 073180038
39	6		1 073180039
40	6,5		1 073180040
41	7		1 073180041
42	8		1 073180042
43	9		1 073180043
44	10		1 073180044
45	10,5		1 073180045
46	11		1 073180046
47	12		1 073180047



CE

EN 20345 S1

7326NKK

leather ankle shoe, waterproof,
with thermally welded membrane and durable rubber outsole



EU	UK	Icon	Code
39	6		1 073260039
40	6,5		1 073260040
41	7		1 073260041
42	8		1 073260042
43	9		1 073260043
44	10		1 073260044
45	10,5		1 073260045
46	11		1 073260046
47	12		1 073260047



CE

EN 20345 S3 HRO

7327NKK

full-grain leather boot,
"POLAR" style, waterproof



EU	UK		
39	6	1	073270039
40	6,5	1	073270040
41	7	1	073270041
42	8	1	073270042
43	9	1	073270043
44	10	1	073270044
45	10,5	1	073270045
46	11	1	073270046

CE



EN 20345 S3 HRO

7327R

inner shoes for boots item 7327NKK



EU	UK		
39	6	1	073270939
40	6,5	1	073270940
41	7	1	073270941
42	8	1	073270942
43	9	1	073270943
44	10	1	073270944
45	10,5	1	073270945
46	11	1	073270946



7328

safety boot, "top visibility"



EU	UK		
38	5	1	073280038
39	6	1	073280039
40	6,5	1	073280040
41	7	1	073280041
42	8	1	073280042
43	9	1	073280043
44	10	1	073280044
45	10,5	1	073280045
46	11	1	073280046
47	12	1	073280047

CE



EN 20345 S5

7328N

safety boot



EU	UK		
38	5	1	073280238
39	6	1	073280239
40	6,5	1	073280240
41	7	1	073280241
42	8	1	073280242
43	9	1	073280243
44	10	1	073280244
45	10,5	1	073280245
46	11	1	073280246
47	12	1	073280247

CE



EN 20345 S5

7329TKK

greased Nubuck boot,
unlined



EU	UK		
38	5	1	073290338
39	6	1	073290339
40	6,5	1	073290340
41	7	1	073290341
42	8	1	073290342
43	9	1	073290343
44	10	1	073290344
45	10,5	1	073290345
46	11	1	073290346
47	12	1	073290347
48	13	1	073290348

CE



EN 20345 S3

7330TKK

greased Nubuck boot,
with synthetic lining



EU	UK		
38	5	1	073300338
39	6	1	073300339
40	6,5	1	073300340
41	7	1	073300341
42	8	1	073300342
43	9	1	073300343
44	10	1	073300344
45	10,5	1	073300345
46	11	1	073300346
47	12	1	073300347
48	13	1	073300348

CE



EN 20345 S3

7336NKK

soft suede ankle shoe, with nylon insets



EU	UK		
38	5	1	073360038
39	6	1	073360039
40	6,5	1	073360040
41	7	1	073360041
42	8	1	073360042
43	9	1	073360043
44	10	1	073360044
45	10,5	1	073360045
46	11	1	073360046
47	12	1	073360047

CE



EN 20345 S1P

7340R

suede shoe,
without steel toe and penetration proof midsole,
with rubber outsole



EU	UK		
38	5	1	073400038
39	6	1	073400039
40	6,5	1	073400040
41	7	1	073400041
42	8	1	073400042
43	9	1	073400043
44	10	1	073400044
45	10,5	1	073400045
46	11	1	073400046
47	12	1	073400047

CE



EN 20347 O1 HRO-FO

7341R

suede ankle shoe,
without steel toe and penetration proof midsole,
with rubber outsole



EU	UK	1	2
38	5	1	073410038
39	6	1	073410039
40	6,5	1	073410040
41	7	1	073410041
42	8	1	073410042
43	9	1	073410043
44	10	1	073410044
45	10,5	1	073410045
46	11	1	073410046
47	12	1	073410047

CE

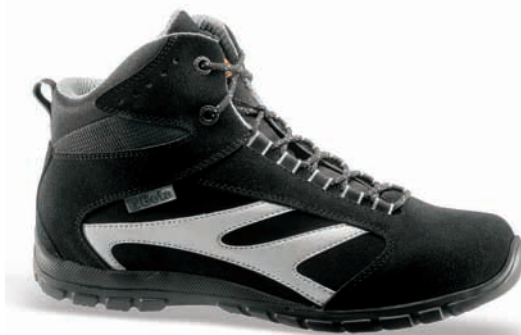

EN 20347 O1 HRO-FO



7342RKK

suede shoe, with rubber outsole



EU	UK	1	2
38	5	1	073420038
39	6	1	073420039
40	6,5	1	073420040
41	7	1	073420041
42	8	1	073420042
43	9	1	073420043
44	10	1	073420044
45	10,5	1	073420045
46	11	1	073420046
47	12	1	073420047

CE

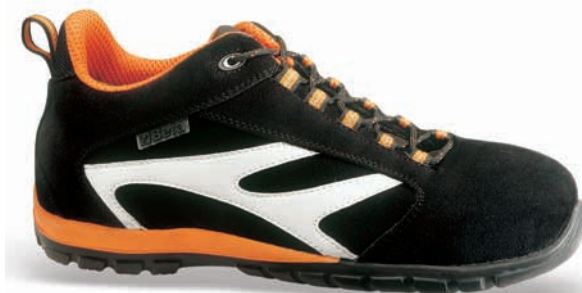

EN 20345 S1P HRO



7342RKK/G

suede shoe, with rubber outsole



EU	UK	1	2
38	5	1	073420138
39	6	1	073420139
40	6,5	1	073420140
41	7	1	073420141
42	8	1	073420142
43	9	1	073420143
44	10	1	073420144
45	10,5	1	073420145
46	11	1	073420146
47	12	1	073420147

CE



EN 20345 S1P HRO



7343RKK

suede ankle shoe, with rubber outsole



EU	UK	1	2
38	5	1	073430038
39	6	1	073430039
40	6,5	1	073430040
41	7	1	073430041
42	8	1	073430042
43	9	1	073430043
44	10	1	073430044
45	10,5	1	073430045
46	11	1	073430046
47	12	1	073430047

CE



EN 20345 S1P HRO



7343RKK/G

suede ankle shoe,
with rubber outsole



EU	UK		
38	5	1	073430138
39	6	1	073430139
40	6,5	1	073430140
41	7	1	073430141
42	8	1	073430142
43	9	1	073430143
44	10	1	073430144
45	10,5	1	073430145
46	11	1	073430146
47	12	1	073430147

CE



EN 20345 S1P HRO



7344RKK

Nubuck shoe, waterproof, with rubber outsole



EU	UK		
38	5	1	073440038
39	6	1	073440039
40	6,5	1	073440040
41	7	1	073440041
42	8	1	073440042
43	9	1	073440043
44	10	1	073440044
45	10,5	1	073440045
46	11	1	073440046
47	12	1	073440047

CE



EN 20345 S3 HRO



7345RKK

Nubuck ankle shoe,
waterproof, with rubber outsole



EU	UK		
38	5	1	073450038
39	6	1	073450039
40	6,5	1	073450040
41	7	1	073450041
42	8	1	073450042
43	9	1	073450043
44	10	1	073450044
45	10,5	1	073450045
46	11	1	073450046
47	12	1	073450047

CE



EN 20345 S3 HRO



7346RKK

suede moccasin
with strap closure and rubber outsole



EU	UK		
38	5	1	073460038
39	6	1	073460039
40	6,5	1	073460040
41	7	1	073460041
42	8	1	073460042
43	9	1	073460043
44	10	1	073460044
45	10,5	1	073460045
46	11	1	073460046
47	12	1	073460047

CE



EN 20345 S1P HRO



7347RKK

perforated suede shoe,
with rubber outsole



EU	UK	
38	5	1 073470038
39	6	1 073470039
40	6,5	1 073470040
41	7	1 073470041
42	8	1 073470042
43	9	1 073470043
44	10	1 073470044
45	10,5	1 073470045
46	11	1 073470046
47	12	1 073470047

CE



EN 20345 S1P HRO



7348RKK

suede shoe,
with mesh insets and rubber outsole



EU	UK	
38	5	1 073480038
39	6	1 073480039
40	6,5	1 073480040
41	7	1 073480041
42	8	1 073480042
43	9	1 073480043
44	10	1 073480044
45	10,5	1 073480045
46	11	1 073480046
47	12	1 073480047

CE



EN 20345 S1P HRO



7349RKK

full-grain leather shoe,
with rubber outsole



EU	UK	
38	5	1 073490038
39	6	1 073490039
40	6,5	1 073490040
41	7	1 073490041
42	8	1 073490042
43	9	1 073490043
44	10	1 073490044
45	10,5	1 073490045
46	11	1 073490046
47	12	1 073490047

CE



EN 20345 S3 HRO



7350RKK

full-grain leather ankle shoe,
with rubber outsole



EU	UK	
38	5	1 073500038
39	6	1 073500039
40	6,5	1 073500040
41	7	1 073500041
42	8	1 073500042
43	9	1 073500043
44	10	1 073500044
45	10,5	1 073500045
46	11	1 073500046
47	12	1 073500047

CE



EN 20345 S3 HRO



7351RKK

suede shoe,
with mesh insets and rubber outsole



EU	UK	
38	5	1 073510038
39	6	1 073510039
40	6,5	1 073510040
41	7	1 073510041
42	8	1 073510042
43	9	1 073510043
44	10	1 073510044
45	10,5	1 073510045
46	11	1 073510046
47	12	1 073510047

CE

EN 20345 S1P HRO

7384B

nylon mesh outdoor jogging shoe,
with PU insets



EU	UK	
36	3,5	1 073840236
37	4,5	1 073840237
38	5	1 073840238
39	6	1 073840239
40	6,5	1 073840240
41	7	1 073840241
42	8	1 073840242
43	9	1 073840243
44	10	1 073840244
45	10,5	1 073840245
46	11	1 073840246



7385B

nylon mesh outdoor jogging shoe,
with PU insets



EU	UK	
36	3,5	1 073850236
37	4,5	1 073850237
38	5	1 073850238
39	6	1 073850239
40	6,5	1 073850240
41	7	1 073850241
42	8	1 073850242
43	9	1 073850243
44	10	1 073850244
45	10,5	1 073850245



7387B

nylon mesh outdoor jogging shoe,
with PU insets



EU	UK	
36	3,5	1 073870236
37	4,5	1 073870237
38	5	1 073870238
39	6	1 073870239
40	6,5	1 073870240
41	7	1 073870241
42	8	1 073870242
43	9	1 073870243
44	10	1 073870244
45	10,5	1 073870245
46	11	1 073870246



7390A

nylon mesh outdoor "raid" shoe,
with PU insets



EU	UK		
37	4,5	1	073900137
38	5	1	073900138
39	6	1	073900139
40	6,5	1	073900140
41	7	1	073900141
42	8	1	073900142
43	9	1	073900143
44	10	1	073900144
45	10,5	1	073900145



7392A

suede outdoor "raid" shoe,
with nylon mesh insets



EU	UK		
40	6,5	1	073920140
41	7	1	073920141
42	8	1	073920142
43	9	1	073920143
44	10	1	073920144
45	10,5	1	073920145



7393

suede outdoor "trekking" shoe,
with nylon mesh insets,
EVA and rubber outsole



EU	UK		
39	6	1	073930039
40	6,5	1	073930040
41	7	1	073930041
42	8	1	073930042
43	9	1	073930043
44	10	1	073930044
45	10,5	1	073930045
46	11	1	073930046



 **Beta**







7398 TNT

interchangeable carbon insoles





EU	UK	USA	J	Icon	Icon
35	2,5	3	22		
36	3,5	4	22,5		
37	4,5	5	23		
38	5	6	24		
39	6	7	24,5		
40	6,5	7,5	25,5		
41	7	8,5	26,5		
42	8	9	27		
43	9	10	28		
44	10	10,5	28,5		
45	10,5	11,5	29,5		
46	11	12	30		
47	12	13	31		
48	13	14	32		

7398BF

anatomically shaped "BLOW-FEET" insoles





EU	UK	USA	J	Icon	Icon
36	3,5	4	22,5		
37	4,5	5	23		
38	5	6	24		
39	6	7	24,5		
40	6,5	7,5	25,5		
41	7	8,5	26,5		
42	8	9	27		
43	9	10	28		
44	10	10,5	28,5		
45	10,5	11,5	29,5		
46	11	12	30		
47	12	13	31		
48	13	14	32		

7398 A/M

anatomically shaped EVA insoles, with microholes





EU	UK	USA	J	Icon	Icon
35	2,5	3	22		
36	3,5	4	22,5		
37	4,5	5	23		
38	5	6	24		
39	6	7	24,5		
40	6,5	7,5	25,5		
41	7	8,5	26,5		
42	8	9	27		
43	9	10	28		
44	10	10,5	28,5		
45	10,5	11,5	29,5		
46	11	12	30		
47	12	13	31		
48	13	14	32		

7398FT

anatomically shaped fusstatic underfoot covers



EU	UK	USA	J	Icon	Icon
36	3,5	4	22,5		
37	4,5	5	23		
38	5	6	24		
39	6	7	24,5		
40	6,5	7,5	25,5		
41	7	8,5	26,5		
42	8	9	27		
43	9	10	28		
44	10	10,5	28,5		
45	10,5	11,5	29,5		
46	11	12	30		
47	12	13	31		
48	13	14	32		

7398C

saddle leather insoles



EU	UK	USA	J		
36	3,5	4	22,5	1	073980436
37	4,5	5	23	1	073980437
38	5	6	24	1	073980438
39	6	7	24,5	1	073980439
40	6,5	7,5	25,5	1	073980440
41	7	8,5	26,5	1	073980441
42	8	9	27	1	073980442
43	9	10	28	1	073980443
44	10	10,5	28,5	1	073980444
45	10,5	11,5	29,5	1	073980445
46	11	12	30	1	073980446
47	12	13	31	1	073980447
48	13	14	32	1	073980448

7398ESD

anatomically shaped insoles for ESD certified footwear



EU	UK	USA	J		
36	3,5	4	22,5	1	073980636
37	4,5	5	23	1	073980637
38	5	6	24	1	073980638
39	6	7	24,5	1	073980639
40	6,5	7,5	25,5	1	073980640
41	7	8,5	26,5	1	073980641
42	8	9	27	1	073980642
43	9	10	28	1	073980643
44	10	10,5	28,5	1	073980644
45	10,5	11,5	29,5	1	073980645
46	11	12	30	1	073980646
47	12	13	31	1	073980647

7399 G/N

pack of 10 pairs of laces, 90 cm



7399 G/N	cm		
90		1	073990009

7399 A/N...

pack of 10 pairs of laces



7399 A/N100	cm		
100		1	073990010
7399 A/N120	120	1	073990012
7399 A/N140	140	1	073990017

7399M...

pack of 10 pairs of laces, brown



7399M 90	cm		
90		1	073990013
7399M 120	120	1	073990014

7399B...

pack of 10 pairs of laces, beige



7399B 90	cm		
90		1	073990015
7399B 120	120	1	073990016

7411

thick ankle length socks made from Outlast® and terry



	EU		
S	37-39	1	074110001
M	40-42	1	074110002
L	43-45	1	074110003
XL	46-48	1	074110004

7398AL

aluminized felt insoles, for low temperatures



EU	UK	USA	J		
38	5	6	24	1	073980538
39	6	7	24,5	1	073980539
40	6,5	7,5	25,5	1	073980540
41	7	8,5	26,5	1	073980541
42	8	9	27	1	073980542
43	9	10	28	1	073980543
44	10	10,5	28,5	1	073980544
45	10,5	11,5	29,5	1	073980545
46	11	12	30	1	073980546
47	12	13	31	1	073980547
48	13	14	32	1	073980548



7412

thick knee length socks
made from Outlast® and terry



	EU		
S	37-39	1	074120001
M	40-42	1	074120002
L	43-45	1	074120003
XL	46-48	1	074120004

7413

ankle length socks
made from terry and polyamide.
Left and right foot specific construction



	EU		
S	37-39	1	074130001
M	40-42	1	074130002
L	43-45	1	074130003
XL	46-48	1	074130004

7414

knee length socks
made from terry and polyamide.
Left and right foot specific construction



	EU		
S	37-39	1	074140001
M	40-42	1	074140002
L	43-45	1	074140003
XL	46-48	1	074140004

7415

ankle length socks
made from Coolmax® and Dryarn®



	EU		
S	37-39	1	074150001
M	40-42	1	074150002
L	43-45	1	074150003
XL	46-48	1	074150004

7416

knee length socks
made from Coolmax® and Dryarn®



	EU		
S	37-39	1	074160001
M	40-42	1	074160002
L	43-45	1	074160003
XL	46-48	1	074160004

7417

ankle length socks made from Tactel®



	EU		
S	37-39	1	074170001
M	40-42	1	074170002
L	43-45	1	074170003
XL	46-48	1	074170004

7418

ankle length socks
made from antibacterial Meryl Skinlife®



	EU		
S	37-39	1	074180001
M	40-42	1	074180002
L	43-45	1	074180003
XL	46-48	1	074180004

Beta



Key

Beta Workwear is the clothing line developed to provide professionals, who often have to work under the most critical conditions, with protection and comfort.

Up-to-the-minute articles made of first-rate materials, designed to satisfy users' practical needs.

item number

7899
sleeveless technical work jacket
in T/C canvas, 270 g/m², grey



size
M
XL

code number
1 078990002
1 078990004

n. of pieces per box



	I	F	D	E	UK	USA
XS	46	38	42	40	30	32
S	48	40	44	42	32	34
M	50	42	46	44	34	36
L	52	44	48	46	36	38
XL	54	46	50	48	38	40
XXL	56	48	52	50	40	42
XXXL	58	50	54	52	42	44



7500

Lightweight 5-pocket trousers,
cotton twill 225 g/m², sand



XS	1	075000046
S	1	075000048
M	1	075000050
L	1	075000052
XL	1	075000054
XXL	1	075000056

7510

multi-pocket trousers,
ribbed T/C 260 g/m², sand



S	1	075100048
M	1	075100050
L	1	075100052
XL	1	075100054
XXL	1	075100056

7511

multi-pocket bermuda shorts,
ribbed T/C 260 g/m², sand



M	1	075110050
L	1	075110052
XL	1	075110054
XXL	1	075110056

7512

multi-pocket trousers,
100% cotton canvas 240 g/m², sand



XS	1	075120046
S	1	075120048
M	1	075120050
L	1	075120052
XL	1	075120054
XXL	1	075120056

7512

multi-pocket trousers,
100% cotton canvas 240 g/m², blue



XS	1	075120146
S	1	075120148
M	1	075120150
L	1	075120152
XL	1	075120154
XXL	1	075120156
XXXL	1	075120158

7512

multi-pocket trousers,
100% cotton canvas 240 g/m², green



XS	1	075120346
S	1	075120348
M	1	075120350
L	1	075120352
XL	1	075120354
XXL	1	075120356
XXXL	1	075120358

Beta
Collection

7513

multi-pocket bermuda shorts,
100% cotton canvas 240 g/m², sand



S	1	075130048
M	1	075130050
L	1	075130052
XL	1	075130054
XXL	1	075130056

7540

lightweight shirt,
100% cotton twill 145 g/m², blue



S	1	075400101
M	1	075400102
L	1	075400103
XL	1	075400104
XXL	1	075400105

7550

three-button polo shirt,
carded pique cotton 220 g/m², black



S	2	075500201
M	2	075500202
L	2	075500203
XL	2	075500204
XXL	2	075500205

7513

multi-pocket bermuda shorts,
100% cotton canvas 240 g/m², blue



XS	1	075130146
S	1	075130148
M	1	075130150
L	1	075130152
XL	1	075130154
XXL	1	075130156
XXXL	1	075130158

7550

three-button polo shirt,
carded pique cotton 220 g/m², grey



S	2	075500101
M	2	075500102
L	2	075500103
XL	2	075500104
XXL	2	075500105

7550

three-button polo shirt,
carded pique cotton 220 g/m², orange



S	2	075500301
M	2	075500302
L	2	075500303
XL	2	075500304
XXL	2	075500305

7513

multi-pocket bermuda shorts,
100% cotton canvas 240 g/m², green



XS	1	075130346
S	1	075130348
M	1	075130350
L	1	075130352
XL	1	075130354
XXL	1	075130356
XXXL	1	075130358

**7552**

technical polo shirt,
Ho-Cooling® 190 g/m², sand



S	2	075520001
M	2	075520002
L	2	075520003
XL	2	075520004
XXL	2	075520005

7552

technical polo shirt,
Ho-Cooling® 190 g/m², blue



S	2	075520101
M	2	075520102
L	2	075520103
XL	2	075520104
XXL	2	075520105

7553

work t-shirt,
100% cotton, 145 g/m², grey



XS	5	075530100
S	5	075530101
M	5	075530102
L	5	075530103
XL	5	075530104
XXL	5	075530105
XXXL	5	075530106

7553D

work t-shirt, 100% cotton, 145 g/m²,
small back print, grey



XS	5	075530120
S	5	075530121
M	5	075530122
L	5	075530123
XL	5	075530124
XXL	5	075530125
XXXL	5	075530126

7554

three-button polo shirt, long-sleeved,
carded pique cotton 220 g/m², black



S	2	075540201
M	2	075540202
L	2	075540203
XL	2	075540204
XXL	2	075540205

7553

work t-shirt,
100% cotton, 145 g/m², black



XS	5	075530200
S	5	075530201
M	5	075530202
L	5	075530203
XL	5	075530204
XXL	5	075530205
XXXL	5	075530206

7553D

work t-shirt, 100% cotton, 145 g/m²,
small back print, black



XS	5	075530220
S	5	075530221
M	5	075530222
L	5	075530223
XL	5	075530224
XXL	5	075530225
XXXL	5	075530226

7553

work t-shirt,
100% cotton, 145 g/m², orange



XS	5	075530000
S	5	075530001
M	5	075530002
L	5	075530003
XL	5	075530004
XXL	5	075530005
XXXL	5	075530006

7553D

work t-shirt, 100% cotton, 145 g/m²,
small back print, orange



XS	5	075530020
S	5	075530021
M	5	075530022
L	5	075530023
XL	5	075530024
XXL	5	075530025
XXXL	5	075530026

7555

lightweight sleeveless jacket,
multi-pocket style, T/C twill 180 g/m², sand



M	1	075550002
L	1	075550003
XL	1	075550004
XXL	1	075550005

7555

lightweight sleeveless jacket,
multi-pocket style, T/C twill 180 g/m², blue



S	1	075550101	
M	1	075550102	
L	1	075550103	
XL	1	075550104	
XXL	1	075550105	

7555

lightweight sleeveless jacket,
multi-pocket style, T/C twill 180 g/m², grey



S	1	075550201	
M	1	075550202	
L	1	075550203	
XL	1	075550204	
XXL	1	075550205	

7566

sleeveless jacket, multi-pocket style,
100% cotton canvas 240 g/m², green



S	1	075660301	
M	1	075660302	
L	1	075660303	
XL	1	075660304	
XXL	1	075660305	
XXXL	1	075660306	

7575A

sleeveless jacket, waterproof ripstop nylon
200 g/m², padded and lined, black



XS	1	075750200	
S	1	075750201	
M	1	075750202	
L	1	075750203	
XL	1	075750204	
XXL	1	075750205	
XXXL	1	075750206	

7576

sleeveless "Taslon" jacket, padded and lined,
brown



XS	1	075760100	
S	1	075760101	
M	1	075760102	
L	1	075760103	
XL	1	075760104	
XXL	1	075760105	
XXXL	1	075760106	

7576

sleeveless "Taslon" jacket, padded and lined,
green



XS	1	075760200	
S	1	075760201	
M	1	075760202	
L	1	075760203	
XL	1	075760204	
XXL	1	075760205	
XXXL	1	075760206	

7595

sleeveless jacket, waterproof "Taslon" nylon
120 g/m², fleece lining, sand



S	1	075950001	
M	1	075950002	
L	1	075950003	
XL	1	075950004	
XXL	1	075950005	

7615

sleeveless jacket, 2-ply laminated fleece
370 g/m², grey



S	1	076150101	
M	1	076150102	
L	1	076150103	
XL	1	076150104	
XXL	1	076150105	

7631

pullover, 2-ply laminated fleece 360 g/m²,
grey/blue



XS	1	076310000	
S	1	076310001	
M	1	076310002	
L	1	076310003	
XL	1	076310004	
XXL	1	076310005	
XXXL	1	076310006	

7635

pullover, microfleece, 180 g/m²,
grey



XS	1	076350010	
S	1	076350011	
M	1	076350012	
L	1	076350013	
XL	1	076350014	
XXL	1	076350015	
XXXL	1	076350016	

7621

jacket, 2-ply laminated fleece 360 g/m²,
grey/blue



XS	1	076210000	
S	1	076210001	
M	1	076210002	
L	1	076210003	
XL	1	076210004	
XXL	1	076210005	
XXXL	1	076210006	

7631

pullover, 2-ply laminated fleece 360 g/m²,
blue/grey



XS	1	076310100	
S	1	076310101	
M	1	076310102	
L	1	076310103	
XL	1	076310104	
XXL	1	076310105	
XXXL	1	076310106	

7640

sweatshirt, 60% cotton, 40% polyester,
320 g/m², front embroidery, grey



XS	1	076400000	
S	1	076400001	
M	1	076400002	
L	1	076400003	
XL	1	076400004	
XXL	1	076400005	
XXXL	1	076400006	

7621

jacket, 2-ply laminated fleece, 360 g/m²,
blue/grey



XS	1	076210100	
S	1	076210101	
M	1	076210102	
L	1	076210103	
XL	1	076210104	
XXL	1	076210105	
XXXL	1	076210106	

7635

pullover, microfleece 180 g/m², black



XS	1	076350000	
S	1	076350001	
M	1	076350002	
L	1	076350003	
XL	1	076350004	
XXL	1	076350005	
XXXL	1	076350006	

7640D

sweatshirt, 60% cotton, 40% polyester,
320 g/m², small back embroidery, grey



XS	1	076400100	
S	1	076400101	
M	1	076400102	
L	1	076400103	
XL	1	076400104	
XXL	1	076400105	
XXXL	1	076400106	

7640D

sweatshirt, 60% cotton, 40% polyester,
320 g/m², small back embroidery, blue



SIZE	QTY	SKU
XS	1	076400120
S	1	076400121
M	1	076400122
L	1	076400123
XL	1	076400124
XXL	1	076400125
XXXL	1	076400126

7690

lightweight bomber jacket, TC/PU, 180 g/m²,
lined, sand



SIZE	QTY	SKU
S	1	076900001
M	1	076900002
L	1	076900003
XL	1	076900004
XXL	1	076900005

7690

lightweight bomber jacket, TC/PU, 180 g/m²,
lined, blue



SIZE	QTY	SKU
S	1	076900101
M	1	076900102
L	1	076900103
XL	1	076900104
XXL	1	076900105

7692

waterproof bomber jacket, ripstop polyester,
padded, lined, blue/grey



SIZE	QTY	SKU
XS	1	076920000
S	1	076920001
M	1	076920002
L	1	076920003
XL	1	076920004
XXL	1	076920005
XXXL	1	076920006

7694

waterproof bomber jacket, Oxford polyester,
brushed, padded, lined, black



SIZE	QTY	SKU
XS	1	076940000
S	1	076940001
M	1	076940002
L	1	076940003
XL	1	076940004
XXL	1	076940005
XXXL	1	076940006

7700

lightweight jacket, waterproof "Oxford"
165 g/m², lined, sand



SIZE	QTY	SKU
S	1	077000001
M	1	077000002
L	1	077000003
XL	1	077000004
XXL	1	077000005

7700

lightweight jacket, waterproof "Oxford"
165 g/m², lined grey



SIZE	QTY	SKU
M	1	077000202
L	1	077000203
XL	1	077000204
XXL	1	077000205

7701

dust coat in PU /TC, waterproof, blue



SIZE	QTY	SKU
S	1	077010001
M	1	077010002
L	1	077010003
XL	1	077010004
XXL	1	077010005

7722

waterproof Parka jacket, printed polyester twill,
padded, lined, grey



SIZE	QTY	SKU
XS	1	077220000
S	1	077220001
M	1	077220002
L	1	077220003
XL	1	077220004
XXL	1	077220005
XXXL	1	077220006

7731

parka jacket, waterproof "Taslon", padded and lined, black. recommended for low temperatures



Size	Code
S	1 077310001
M	1 077310002
L	1 077310003
XL	1 077310004

7732

parka jacket, waterproof "Taslon", with removable jacket, black/blue. Fleece lining



Size	Code
XS	1 077320000
S	1 077320001
M	1 077320002
L	1 077320003
XL	1 077320004
XXL	1 077320005
XXXL	1 077320006

7740

parka jacket, T/C canvas 290 g/m², padded, lined and quilted, sand



Size	Code
S	1 077400001
M	1 077400002
L	1 077400003
XL	1 077400004
XXL	1 077400005

7740

parka jacket, T/C canvas 290 g/m², padded, lined and quilted, brown



Size	Code
S	1 077400201
M	1 077400202
L	1 077400203
XL	1 077400204

7790

jacket, Teijin® microfiber and goose down 50/50 300 g/m², removable sleeves, orange



Size	Code
S	1 077900001
M	1 077900002
L	1 077900003
XL	1 077900004
XXL	1 077900005

7910N

work trousers in prewashed stretch cotton twill, 240 g/m², black



Size	Code
XS	1 079100000
S	1 079100001
M	1 079100002
L	1 079100003
XL	1 079100004
XXL	1 079100005
XXXL	1 079100006

7910Y

work trousers in prewashed stretch cotton twill, 240 g/m², mud brown



Size	Code
XS	1 079100100
S	1 079100101
M	1 079100102
L	1 079100103
XL	1 079100104
XXL	1 079100105
XXXL	1 079100106

7920N

work trousers in prewashed stretch cotton canvas, 260 g/m², black



XS	1 079200000
S	1 079200001
M	1 079200002
L	1 079200003
XL	1 079200004
XXL	1 079200005
XXXL	1 079200006

7920Y

work trousers in prewashed stretch cotton canvas, 260 g/m², mud brown



XS	1 079200100
S	1 079200101
M	1 079200102
L	1 079200103
XL	1 079200104
XXL	1 079200105
XXXL	1 079200106

7800

work trousers in T/C twill 210 g/m², "Oxford" insets, tobacco



XS	1 078000000
S	1 078000001
M	1 078000002
L	1 078000003
XL	1 078000004
XXL	1 078000005
XXXL	1 078000006

7800G

work knee pads pair



7800G	1 078000500
-------	-------------

7801

work shorts in T/C twill 210 g/m², "Oxford" insets, tobacco



XS	1 078010000
S	1 078010001
M	1 078010002
L	1 078010003
XL	1 078010004
XXL	1 078010005
XXXL	1 078010006

7803

work overalls in T/C twill 210 g/m², "Oxford" insets, tobacco



XS	1 078030000
S	1 078030001
M	1 078030002
L	1 078030003
XL	1 078030004
XXL	1 078030005
XXXL	1 078030006

7805

Work overalls, T/C twill 210 g/m², "Oxford" insets, removable sleeves, tobacco



XS	1 078050000
S	1 078050001
M	1 078050002
L	1 078050003
XL	1 078050004
XXL	1 078050005

7807

sleeveless work jacket in T/C twill 210 g/m²,
"Oxford" insets, tobacco



SIZE	QTY	SKU
XS	1	078070000
S	1	078070001
M	1	078070002
L	1	078070003
XL	1	078070004
XXL	1	078070005

7808

work overall in T/C twill, 210 g/m², tobacco



SIZE	QTY	SKU
M	1	078080002
XL	1	078080004

7809

work jacket, T/C twill 210 g/m²,
"Oxford" insets, removable sleeves, tobacco



SIZE	QTY	SKU
XS	1	078090000
S	1	078090001
M	1	078090002
L	1	078090003
XL	1	078090004
XXL	1	078090005
XXXL	1	078090006

7840

work trousers, T/C twill 200 g/m²,
grey/orange



SIZE	QTY	SKU
XS	1	078400000
S	1	078400001
M	1	078400002
L	1	078400003
XL	1	078400004
XXL	1	078400005
XXXL	1	078400006

7841

work shorts, T/C twill 200 g/m²,
grey/orange



SIZE	QTY	SKU
XS	1	078410000
S	1	078410001
M	1	078410002
L	1	078410003
XL	1	078410004
XXL	1	078410005
XXXL	1	078410006

7843

work overalls, T/C twill 200 g/m²,
grey/orange



SIZE	QTY	SKU
XS	1	078430000
S	1	078430001
M	1	078430002
L	1	078430003
XL	1	078430004
XXL	1	078430005
XXXL	1	078430006

7845

lightweight work overalls, T/C twill 200 g/m²,
grey/orange



SIZE	QTY	SKU
XS	1	078450000
S	1	078450001
M	1	078450002
L	1	078450003
XL	1	078450004
XXL	1	078450005
XXXL	1	078450006



7849

work jacket, T/C twill 200 g/m²,
grey/orange



XS	1	078490000
S	1	078490001
M	1	078490002
L	1	078490003
XL	1	078490004
XXL	1	078490005
XXXL	1	078490006

7850

work trousers in T/C twill, 180 g/m²,
with T/C ripstop insets, sand



XS	1	078500000
S	1	078500001
M	1	078500002
L	1	078500003
XL	1	078500004
XXL	1	078500005
XXXL	1	078500006

7853

work overalls, T/C twill 180 g/m²,
T/C ripstop insets, sand



XS	1	078530000
S	1	078530001
M	1	078530002
L	1	078530003
XL	1	078530004
XXL	1	078530005
XXXL	1	078530006

7855

lightweight work overalls in T/C twill,
180 g/m², with T/C ripstop insets, sand



XS	1	078550000
S	1	078550001
M	1	078550002
L	1	078550003
XL	1	078550004
XXL	1	078550005
XXXL	1	078550006

7857

sleeveless work jacket in T/C twill, 180 g/m²,
with T/C ripstop insets, sand



XS	1	078570000
S	1	078570001
M	1	078570002
L	1	078570003
XL	1	078570004
XXL	1	078570005
XXXL	1	078570006

7859

work jacket in T/C twill, 180 g/m²,
with T/C ripstop insets, sand



XS	1	078590000
S	1	078590001
M	1	078590002
L	1	078590003
XL	1	078590004
XXL	1	078590005
XXXL	1	078590006



7860

work trousers in T/C twill, 180 g/m², with T/C ripstop insets, grey



XS	1 078600000
S	1 078600001
M	1 078600002
L	1 078600003
XL	1 078600004
XXL	1 078600005
XXXL	1 078600006

7861

work shorts, T/C twill, 180 g/m², with T/C ripstop insets, grey



XS	1 078610000
S	1 078610001
M	1 078610002
L	1 078610003
XL	1 078610004
XXL	1 078610005
XXXL	1 078610006

7863

work overalls, T/C twill 180 g/m², T/C ripstop insets, grey



XS	1 078630000
S	1 078630001
M	1 078630002
L	1 078630003
XL	1 078630004
XXL	1 078630005
XXXL	1 078630006

7865

lightweight work overalls in T/C twill, 180 g/m², with T/C ripstop insets, grey



XS	1 078650000
S	1 078650001
M	1 078650002
L	1 078650003
XL	1 078650004
XXL	1 078650005
XXXL	1 078650006

7867

sleeveless work jacket in T/C twill, 180 g/m², with T/C ripstop insets, grey



XS	1 078670000
S	1 078670001
M	1 078670002
L	1 078670003
XL	1 078670004
XXL	1 078670005
XXXL	1 078670006

7869

work jacket in T/C twill, 180 g/m², with T/C ripstop insets, grey



XS	1 078690000
S	1 078690001
M	1 078690002
L	1 078690003
XL	1 078690004
XXL	1 078690005
XXXL	1 078690006



7870

work trousers in T/C twill, 180 g/m²,
with T/C ripstop insets, blue



XS	1 078700000
S	1 078700001
M	1 078700002
L	1 078700003
XL	1 078700004
XXL	1 078700005
XXXL	1 078700006

7871

work shorts, T/C twill, 180 g/m²
with T/C ripstop insets, blue



XS	1 078710000
S	1 078710001
M	1 078710002
L	1 078710003
XL	1 078710004
XXL	1 078710005
XXXL	1 078710006

7873

work overalls, T/C twill 180 g/m²,
T/C ripstop insets, blue



XS	1 078730000
S	1 078730001
M	1 078730002
L	1 078730003
XL	1 078730004
XXL	1 078730005
XXXL	1 078730006

7875

lightweight work overalls in T/C twill,
180 g/m², with T/C ripstop insets, blue



XS	1 078750000
S	1 078750001
M	1 078750002
L	1 078750003
XL	1 078750004
XXL	1 078750005
XXXL	1 078750006

7877

sleeveless work jacket in T/C twill,
180 g/m², with T/C ripstop insets, blue



XS	1 078770000
S	1 078770001
M	1 078770002
L	1 078770003
XL	1 078770004
XXL	1 078770005
XXXL	1 078770006

7879

work jacket in T/C twill, 180 g/m²,
with T/C ripstop insets, blue



XS	1 078790000
S	1 078790001
M	1 078790002
L	1 078790003
XL	1 078790004
XXL	1 078790005
XXXL	1 078790006

7899

sleeveless technical work jacket
in T/C canvas, 270 g/m², grey



M	1 078990002
XL	1 078990004

7900

work trousers in T/C canvas 270 g/m²,
"Oxford" insets, grey



XS	1 079000100
S	1 079000101
M	1 079000102
L	1 079000103
XL	1 079000104
XXL	1 079000105
XXXL	1 079000106

7900FP

work trousers in T/C canvas, 270 g/m²,
with fly pockets, grey



XS	1 079000200
S	1 079000201
M	1 079000202
L	1 079000203
XL	1 079000204
XXL	1 079000205
XXXL	1 079000206

Beta

7901

work shorts in T/C canvas 270 g/m²,
"Oxford" insets, grey



XS	1 079010100
S	1 079010101
M	1 079010102
L	1 079010103
XL	1 079010104
XXL	1 079010105
XXXL	1 079010106

7903

work overalls in T/C canvas 270 g/m²,
"Oxford" insets, grey



XS	1 079030100
S	1 079030101
M	1 079030102
L	1 079030103
XL	1 079030104
XXL	1 079030105
XXXL	1 079030106

7902

bomber jacket, unlined, T/C canvas, 270 g/m²,
Oxford insets, grey



XS	1 079020100
S	1 079020101
M	1 079020102
L	1 079020103
XL	1 079020104
XXL	1 079020105
XXXL	1 079020106

7904

work jacket, T/C canvas 270 g/m²,
padded and lined, "Oxford" insets, grey



XS	1 079040100
S	1 079040101
M	1 079040102
L	1 079040103
XL	1 079040104
XXL	1 079040105
XXXL	1 079040106

Beta



7905

work overalls, T/C canvas 270 g/m², "Oxford" insets, removable sleeves, grey



XS	1	079050100
S	1	079050101
M	1	079050102
L	1	079050103
XL	1	079050104
XXL	1	079050105
XXXL	1	079050106

7907

sleeveless work jacket in T/C canvas 270 g/m², "Oxford" insets, grey



XS	1	079070100
S	1	079070101
M	1	079070102
L	1	079070103
XL	1	079070104
XXL	1	079070105
XXXL	1	079070106

7908

work overall in T/C canvas, 270 g/m², grey



M	1	079080102
XL	1	079080104

7909

work jacket, T/C canvas g/m², "Oxford" insets, removable sleeves, grey



XS	1	079090100
S	1	079090101
M	1	079090102
L	1	079090103
XL	1	079090104
XXL	1	079090105
XXXL	1	079090106

7950

work trousers, T/C canvas 270 g/m², T/C ripstop insets, blue



XS	1	079500000
S	1	079500001
M	1	079500002
L	1	079500003
XL	1	079500004
XXL	1	079500005
XXXL	1	079500006

7951

work shorts, T/C canvas 270 g/m², T/C ripstop insets, blue



XS	1	079510000
S	1	079510001
M	1	079510002
L	1	079510003
XL	1	079510004
XXL	1	079510005
XXXL	1	079510006



7953

work overalls, T/C canvas 270 g/m²,
T/C ripstop insets, blue



XS	1 079530000
S	1 079530001
M	1 079530002
L	1 079530003
XL	1 079530004
XXL	1 079530005
XXXL	1 079530006

7955

work overalls, T/C canvas 270 g/m²,
T/C ripstop insets, blue



XS	1 079550000
S	1 079550001
M	1 079550002
L	1 079550003
XL	1 079550004
XXL	1 079550005
XXXL	1 079550006

7959

work jacket, T/C canvas 270 g/m²,
T/C ripstop insets, blue



XS	1 079590000
S	1 079590001
M	1 079590002
L	1 079590003
XL	1 079590004
XXL	1 079590005
XXXL	1 079590006

7930

work trousers, 100% cotton, 260 g/m²,
davy grey



XS	1 079300000
S	1 079300001
M	1 079300002
L	1 079300003
XL	1 079300004
XXL	1 079300005
XXXL	1 079300006

7930

work trousers, 100% cotton, 260 g/m²,
payne grey



XS	1 079300100
S	1 079300101
M	1 079300102
L	1 079300103
XL	1 079300104
XXL	1 079300105
XXXL	1 079300106

7931

work shorts, 100% cotton, 260 g/m²,
davy grey



XS	1 079310000
S	1 079310001
M	1 079310002
L	1 079310003
XL	1 079310004
XXL	1 079310005
XXXL	1 079310006

7931

work shorts, 100% cotton, 260 g/m²,
payne grey



SIZE	ITEM NO.
XS	1 079310100
S	1 079310101
M	1 079310102
L	1 079310103
XL	1 079310104
XXL	1 079310105
XXXL	1 079310106

7933

work overalls, 100% cotton, 260 g/m²,
davy grey



SIZE	ITEM NO.
XS	1 079330000
S	1 079330001
M	1 079330002
L	1 079330003
XL	1 079330004
XXL	1 079330005
XXXL	1 079330006

7933

work overalls, 100% cotton, 260 g/m²,
payne grey



SIZE	ITEM NO.
XS	1 079330100
S	1 079330101
M	1 079330102
L	1 079330103
XL	1 079330104
XXL	1 079330105
XXXL	1 079330106

7935

work overalls, 100% cotton, 260 g/m²,
davy grey



SIZE	ITEM NO.
XS	1 079350000
S	1 079350001
M	1 079350002
L	1 079350003
XL	1 079350004
XXL	1 079350005
XXXL	1 079350006

7935

work overalls, 100% cotton, 260 g/m²,
payne grey



SIZE	ITEM NO.
XS	1 079350100
S	1 079350101
M	1 079350102
L	1 079350103
XL	1 079350104
XXL	1 079350105
XXXL	1 079350106

7937

sleeveless work jacket, 100% cotton,
260 g/m², davy grey



SIZE	ITEM NO.
XS	1 079370000
S	1 079370001
M	1 079370002
L	1 079370003
XL	1 079370004
XXL	1 079370005
XXXL	1 079370006



7937

sleeveless work jacket, 100% cotton,
260 g/m², payne grey



XS	1	079370100
S	1	079370101
M	1	079370102
L	1	079370103
XL	1	079370104
XXL	1	079370105
XXXL	1	079370106

7939

work jacket, 100% cotton, 260 g/m²,
davy grey



XS	1	079390000
S	1	079390001
M	1	079390002
L	1	079390003
XL	1	079390004
XXL	1	079390005
XXXL	1	079390006

7939

work jacket, 100% cotton, 260 g/m²,
payne grey



XS	1	079390100
S	1	079390101
M	1	079390102
L	1	079390103
XL	1	079390104
XXL	1	079390105
XXXL	1	079390106

7970

waterproof trousers in PVC Tricot, blue



XS	1	079700000
S	1	079700001
M	1	079700002
L	1	079700003
XL	1	079700004
XXL	1	079700005

7973

waterproof overalls in PVC Tricot, blue



XS	1	079730000
S	1	079730001
M	1	079730002
L	1	079730003
XL	1	079730004
XXL	1	079730005

7979

waterproof jacket in PVC Tricot, blue



S	1	079790001
M	1	079790002
L	1	079790003
XL	1	079790004
XXL	1	079790005

7980

pocket rain hat, PU nylon, black



M	5	079800002
L	5	079800003
XL	5	079800004

7981

cap, wool and Thinsulate™ 150 g/m², black



M	5	079810002
XL	5	079810004

7982cap, T/C canvas 270 g/m², grey

7982

5 079820009

7983cap, T/C twill 210 g/m², tobacco

7983

5 079830009

C62EV/VO

floor workwear display



C62EV/VO

1 062000320

C62EV/C

floor display for 10 shoes

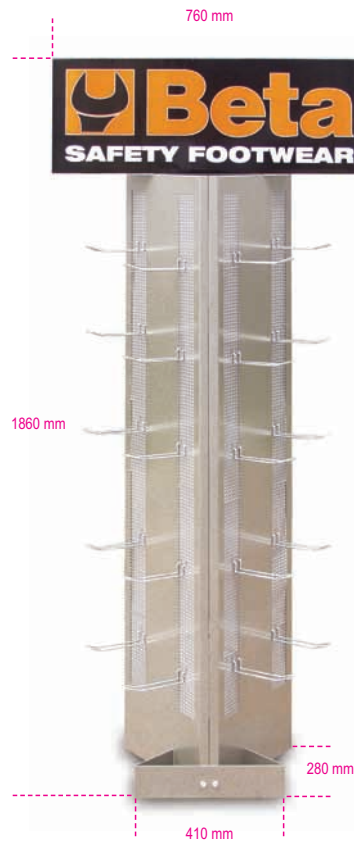

C62EV/C

1 062000100

C62EV/WW

floor workwear and safety footwear display

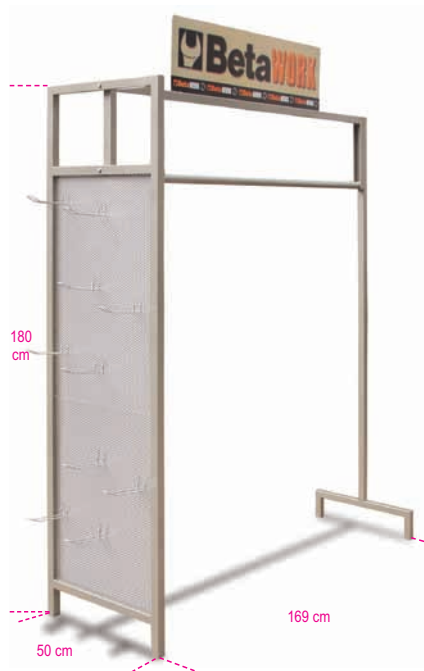

C62EV/WW

1 062000500

C62

floor workwear and safety footwear display

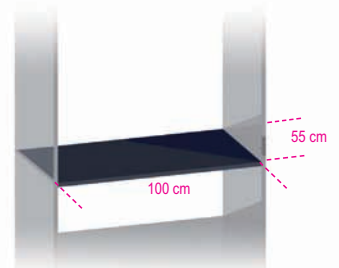

C62/1	1 m	1 062000001
C62/2	2 m	1 062000002
C62/3	3 m	1 062000003
C62/4	4 m	1 062000004

accessories

C62/R

1 062000050



Robur

Since 1930 Robur has been manufacturing accessory lines for cables according to the acknowledged quality standards of Beta Utensili, whose products are complementary to those of Robur.

Expertise, organization and technology are the key ingredients of ongoing growth resulting from awareness of market requirements.

Since 1984 Robur has been headquartered in a state-of-the-art production facility in Sulmona.

Key

item number

8041EALZ

lifting eyebolts,
galvanized

CE



DIN 580:2003

size

Ø mm	mm	WLL kg	
M8	1,25	140	60 080410108
M10	1,5	230	50 080410110
M12	1,75	340	25 080410112
M14	2	480	25 080410114
M16	2	700	1 080410116
M18	2,5	930	1 080410118
M20	2,5	1200	1 080410120
M22	2,5	1450	1 080410122
M24	3	1800	1 080410124

code number

n.° of tools per box

MAXIMUM WORKING LOAD

WLL: working load limit
(for lifting accessories)

BF: Maximum force achieved by the item
during the static traction test

WFL: workforce limit
(for accessories other than lifting accessories)

LC: lashing capacity

A mm	WFL kg	B mm		
12	650	42	1	081160012
14	820	48	1	081160014
16	1000	57	1	081160016
18	1600	64	1	081160018
20	2000	72	1	081160020
22	2500	80	1	081160022

8302Z

fastening eye bolts right thread, galvanized

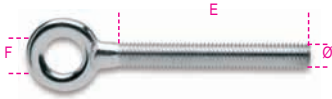

Ø mm	E mm	F mm	WFL kg		
M5	48	8	115	200	083020005
M6	55	10	160	150	083020006
M8	60	12	300	100	083020008
M10	73	14	470	100	083020010
M12	90	17	690	50	083020012

8303Z

fastening hooks right thread, galvanized

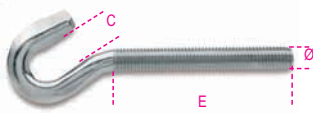

Ø mm	C mm	E mm	WFL kg		
M5	6,0	48	25	150	083030005
M6	8,0	55	45	120	083030006
M8	10,0	60	95	100	083030008
M10	12,5	73	140	70	083030010
M12	16,0	90	220	30	083030012

8345Z

eyebolts for scaffolding galvanized

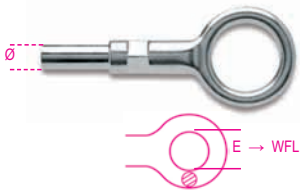

Ø mm	E mm	WFL kg		
M10	50	1300	1	083450110
M12	50	1400	1	083450112

8346Z

eyebolt for scaffolding galvanized

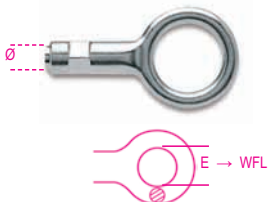

Ø mm	E mm	WFL kg		
M12	50	1600	1	083460112

8381SL

U bolts for pipes light series, galvanized

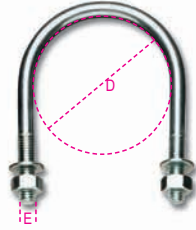

D mm	D gas	E mm		
11	1/8"	M6	250	083810201
14	1/4"	M6	250	083810202
18	3/8"	M6	250	083810203
22	1/2"	M6	250	083810204
27	3/4"	M6	250	083810205
34	1"	M6	250	083810206
43	1 1/4"	M6	250	083810207
49	1 1/2"	M8	200	083810208
61	2"	M8	200	083810209
77	2 1/2"	M8	100	083810210
89	3"	M8	100	083810211
102	3 1/2"	M8	100	083810212
115	4"	M8	100	083810213

8381SP

U bolts for pipes heavy series, galvanized

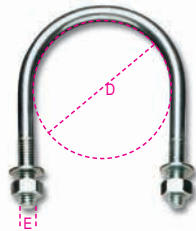

D mm	D gas	E mm		
22	1/2"	M8	200	083810301
27	3/4"	M8	200	083810302
34	1"	M8	200	083810303
43	1 1/4"	M8	200	083810304
49	1 1/2"	M10	100	083810305
61	2"	M10	100	083810306
77	2 1/2"	M10	100	083810307
89	3"	M10	50	083810308
102	3 1/2"	M12	50	083810309
115	4"	M12	50	083810310

8383C

square U bolts for agricultural use hot galvanized

Flanged nuts



A mm	E mm	B mm	D mm		
70	M10	110	8,55	130	083830070
80	M10	120	8,55	110	083830080
90	M10	130	8,55	100	083830090
100	M10	155	8,55	90	083830100
120	M10	175	8,55	70	083830120

8383P

plates for square U bolts hot galvanized

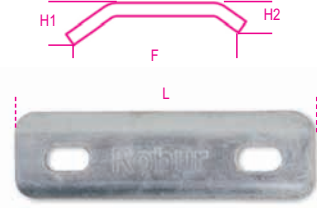

8383P/150	150	083830214
8383C/70-80-90-100		
8383P/170	120	083830217
8383C/100-120		

8515Z

wire pullers for agriculture, galvanized

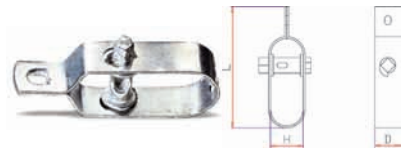

D mm	H mm	L mm		
20	25	93	100	085150002
24,5	30	100	70	085150003

8515V

wire pullers for agriculture, galvanized and painted



D mm	H mm	L mm		
20	25	93	100	085150102
24,5	30	100	70	085150103

8535

fishing hooks, galvanized

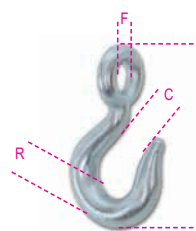

R mm	C mm	F mm	L mm		
26	27,5	34	156	1	085350006
30	36,5	40	185	1	085350007

8051S

eye hooks, galvanized

CE

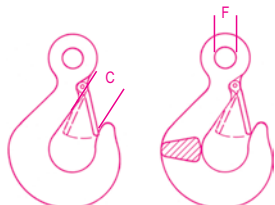

WLL kg	C mm	F mm	
250	14	12	1 080510202
500	18	16,5	1 080510205

8055S

alloy steel eye hooks,
hardened and tempered

CE



EN 1677-2
GRADO 8

WLL kg	C mm	F mm	
1250	20	19	1 080550110
1600	22	25	1 080550115
2500	23	28	1 080550120
3200	27	32	1 080550130
5400	32	40	1 080550145
8000	41	51	1 080550170
11500	53	64	1 080550215
16000	58	70	1 080550260
22000	78	90	1 080550320

8057

alloy steel self-locking eye hooks,
hardened and tempered

CE

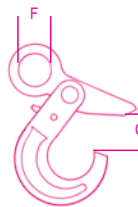

EN 1677-3
GRADO 8

WLL kg	C mm	F mm	Ø mm	
2000	33	25	7-8	1 080570020
3150	44	32	10	1 080570032
5300	54	40	13	1 080570053

8058

alloy steel self-locking Clevis hooks
hardened, tempered and varnished

CE

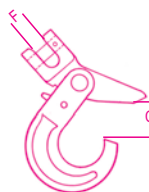

EN 1677-3
GRADO 8

WLL kg	C mm	F mm	Ø mm	
2000	33	10	7-8	1 080580020
3150	44	13	10	1 080580032
5300	54	16	13	1 080580053

8060

alloy steel Clevis chain hooks,
hardened and tempered

CE

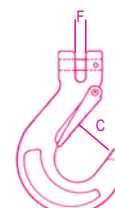

EN 1677-2
GRADO 8

WLL kg	C mm	F mm	Ø mm	
1120	20	7,5	6	1 080600011
2000	25	9,5	7-8	1 080600020
3150	33	12,0	10	1 080600032
5300	43	15,5	13	1 080600053
8000	48	19	16	1 080600080

8061F

jaw grab hooks
with safety lock,
high-grade alloy steel

CE

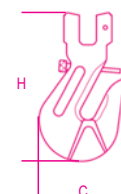

EN 1677-1
GRADO 8

WLL kg	C mm	H mm	Ø mm	
1120	41	72	6	1 080610111
2000	54	96	7-8	1 080610120
3150	75	124	10	1 080610131
5300	93	154	13	1 080610153
8000	108	179	16	1 080610180

8062

alloy steel slip hooks

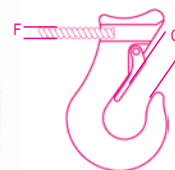

WLL kg	C mm	F mm	
1500	19	10-13	1 080620013
2000	21	16	1 080620016
3000	26	18	1 080620018
5000	34	22-25	1 080620025

Robur



8064Scarbon steel swivel hooks,
hardened and tempered

CE

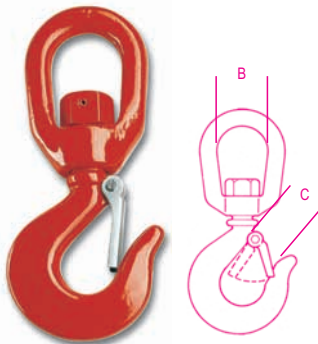

GRADO 4

WLL kg	B mm	C mm		
800	31	20	1	080640107
1000	40	22	1	080640110
1600	47	23	1	080640115
2000	47	27	1	080640120
3200	64	35	1	080640130
5000	77	43	1	080640150
7500	90	53	1	080640175
10000	96	58	1	080640199

8065SC

carbon steel swivel load hooks

CE

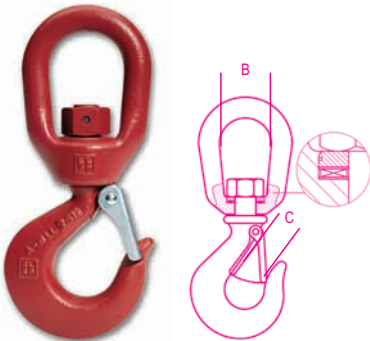

GRADO 4

WLL kg	B mm	C mm		
800	31	20	1	080650107
1000	40	22	1	080650110
1600	47	23	1	080650115
2000	47	27	1	080650120
3200	64	35	1	080650130
5000	77	43	1	080650150

8069

alloy steel weld-on "C" hooks

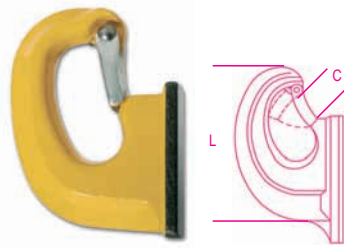

WLL kg	C mm	L mm		
1000	21	105	1	080690010
2000	25	130	1	080690020
3000	25	133	1	080690030
4000	38	177	1	080690040
5000	40	185	1	080690050
6000	40	198	1	080690060
8000	45	250	1	080690080
10000	50	262	1	080690100
18000	50	290	1	080690180

8050D

spare catch kit for hooks

8050D1 8053S-8064S-8065SC/800 8055/1250	1	080500945
8050D2 8053S-8064S-8065SC/1000 8055S/1600	1	080500946
8050D3 8053S-8064S-8065SC/1600-2000 8055/2500-3200	1	080500947
8050D4 8053S-8064S-8065SC/3200 8055S/5400	1	080500948
8050D5 8053S-8064S-8065SC/5000 8055S/8000	1	080500949
8050D6 8064S/7500 8055S/11500	1	080500950
8050D7 8060/3150	1	080500951
8050D8 8060/5300	1	080500952
8050D7A 8060/2000	1	080500968
8050D10 8062/1500	1	080500954
8050D11 8062/2000	1	080500955
8050D12 8062/3000	1	080500956
8050D13 8062/5000	1	080500957
8050D18 8069/1000	1	080500962
8050D19 8069/2000-3000	1	080500963
8050D20 8069/4000-5000-6000	1	080500964
8050D21 8069/8000-10000-18000	1	080500965
8050D22 8053S-8064S/10000 8055S/16000	1	080500966
8050D23 8055S/22000	1	080500967
8050D24 8051S/250	1	080500969
8050D25 8051S/500	1	080500970
8050D26 8061F/1120	1	080500971
8050D27 8061F/2000	1	080500972

8050D28 8061F/3150	1	080500973
8050D29 8061F/5300	1	080500974
8050D30 8061F/8000	1	080500975

8085alloy steel master links,
hardened and tempered

WLL means the use with 1 chain sling.

CE

EN 1677-4
GRADO 8

WLL kg	Ø mm		
* 1500	7	1	080850016
2000	8	1	080850020
3150	10	1	080850032
5300	13	1	080850054
8000	16	1	080850080
11200	19	1	080850190

8086master link assemblies
made from alloy steel,
hardened and tempered* WLL means the use with 3 or 4 chain slings
and β angle < 45°.

CE

EN 1677-4
GRADO 8

WLL kg	Ø mm		
* 3150	7	1	080860021
4250	8	1	080860042
6700	10	1	080860067
11200	13	1	080860100
17000	16	1	080860117

*If you match it with a chain 7 mm in Ø, WLL=3150 Kg.



8090

connecting links made from alloy steel, hardened and tempered

CE



EN 1677-1
GRADO 8

WLL kg	Ø mm		
1120	6	1	080900011
2000	7-8	1	080900020
3150	10	1	080900032
5300	13	1	080900053
8000	16	1	080900080

8090F

connecting links for polyester slings, high-grade alloy steel

CE

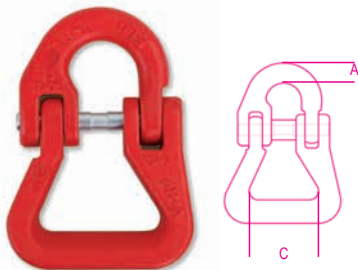

EN 1677-1
GRADO 8

WLL kg	A mm	C mm	Ø mm		
2000	10,5	40	7-8	1	080900220
3150	12	50	10	1	080900232
5300	17	60	13	1	080900253
8000	21	75	16	1	080900280

8100

chains - grade 8, alloy steel, hardened and tempered steel, self-coloured

CE

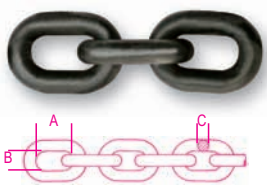

EN 818-2
GRADO 8

WLL kg	A mm	B mm	C mm		
1120	18	7,8	6	1	081000011
1500	21	9,1	7	1	081000016
2000	24	10,4	8	1	081000020
3150	30	13	10	1	081000032
5300	39	16,9	13	1	081000053
8000	48	20,8	16	1	081000080

8091

sling chains, 1 leg
in case

Self-locking and grab hooks available on request

CE

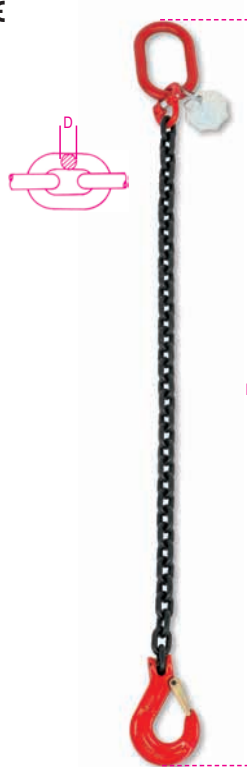

UNI EN 818-4

D mm	L mm	WLL kg		
6	1	1,12	1	080910061
6	2	1,12	1	080910062
6	3	1,12	1	080910063
6	4	1,12	1	080910064
7	1	1,5	1	080910071
7	2	1,5	1	080910072
7	3	1,5	1	080910073
7	4	1,5	1	080910074
8	1	2	1	080910081
8	2	2	1	080910082
8	3	2	1	080910083
8	4	2	1	080910084
10	1	3,15	1	080910101
10	2	3,15	1	080910102
10	3	3,15	1	080910103
10	4	3,15	1	080910104
13	1	5,3	1	080910131
13	2	5,3	1	080910132
13	3	5,3	1	080910133
13	4	5,3	1	080910134
16	1	8	1	080910161
16	2	8	1	080910162
16	3	8	1	080910163
16*	4	8	1	080910164

* Wooden packing suited to weight

8092

sling chains, 2 legs
in case

Self-locking and grab hooks available on request

CE



UNI EN 818-4

D mm	L mm	WLL kg		
6	1	1,6	1	080920061
6	2	1,6	1	080920062
6	3	1,6	1	080920063
6	4	1,6	1	080920064
7	1	2,12	1	080920071
7	2	2,12	1	080920072
7	3	2,12	1	080920073
7	4	2,12	1	080920074
8	1	2,8	1	080920081
8	2	2,8	1	080920082
8	3	2,8	1	080920083
8	4	2,8	1	080920084
10	1	4,25	1	080920101
10	2	4,25	1	080920102
10	3	4,25	1	080920103
10	4	4,25	1	080920104
13	1	7,5	1	080920131
13	2	7,5	1	080920132
13*	3	7,5	1	080920133
13*	4	7,5	1	080920134
16	1	11,2	1	080920161
16*	2	11,2	1	080920162
16*	3	11,2	1	080920163
16*	4	11,2	1	080920164

* Wooden packing suited to weight

Robur

8094

sling chains, 4 legs
in case
Self-locking and grab hooks available on request

CE



UNI EN 818-4

D mm	L mm	WLL kg	
6	1	2,36	1 080940061
6	2	2,36	1 080940062
6	3	2,36	1 080940063
6	4	2,36	1 080940064
7	1	3,15	1 080940071
7	2	3,15	1 080940072
7	3	3,15	1 080940073
7	4	3,15	1 080940074
8	1	4,25	1 080940081
8	2	4,25	1 080940082
8*	3	4,25	1 080940083
8*	4	4,25	1 080940084
10	1	6,7	1 080940101
10*	2	6,7	1 080940102
10*	3	6,7	1 080940103
10*	4	6,7	1 080940104
13*	1	11,2	1 080940131
13*	2	11,2	1 080940132
13*	3	11,2	1 080940133
13*	4	11,2	1 080940134
16*	1	17	1 080940161
16*	2	17	1 080940162
16*	3	17	1 080940163
16*	4	17	1 080940164

* Wooden packing suited to weight

WLL Ton

UNI EN 818

D mm	90°		
	$0^\circ < \beta \leq 45^\circ$	$45^\circ < \beta \leq 60^\circ$	
6	1,12	1,6	1,12
7	1,5	2,12	1,5
8	2	2,8	2
10	3,15	4,25	3,15
13	5,3	7,5	5,3
16	8	11,2	8

D mm	$0^\circ < \beta \leq 45^\circ$		$45^\circ < \beta \leq 60^\circ$	
	6	2,36	11,2	
7	3,15	2,24		
8	4,25	3		
10	6,7	4,75		
13	11,2	8		
16	17	11,2		

8150

webslings

CE

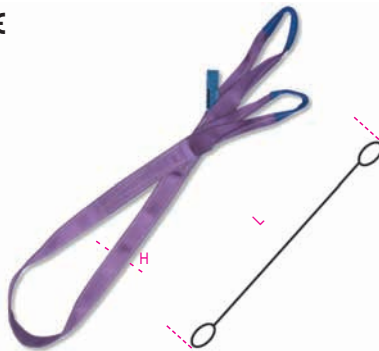

UNI EN 1492-1

L m	H mm	WLL ton	
1	30	1	1 081500010
2	30	1	1 081500020
3	30	1	1 081500030
4	30	1	1 081500040
5	30	1	1 081500050
6	30	1	1 081500060

8153

webslings

CE



UNI EN 1492-1

L m	H mm	WLL ton	
1	60	2	1 081530010
2	60	2	1 081530020
3	60	2	1 081530030
4	60	2	1 081530040
5	60	2	1 081530050
6	60	2	1 081530060

8156

webslings

CE

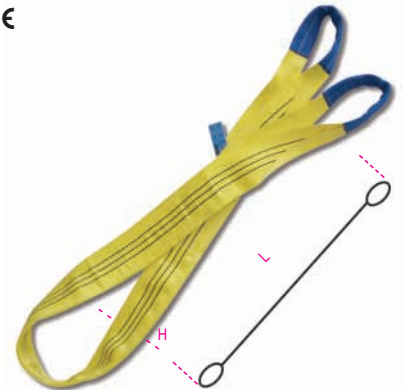

UNI EN 1492-1

L m	H mm	WLL ton	
2	90	3	1 081560020
3	90	3	1 081560030
4	90	3	1 081560040
5	90	3	1 081560050
6	90	3	1 081560060

Robur



Robur



8157

webslings

CE



UNI EN 1492-1

L m	H mm	WLL ton		
2	120	4	1	081570020
3	120	4	1	081570030
4	120	4	1	081570040
5	120	4	1	081570050
6	120	4	1	081570060
8	120	4	1	081570080

8158

webslings

CE

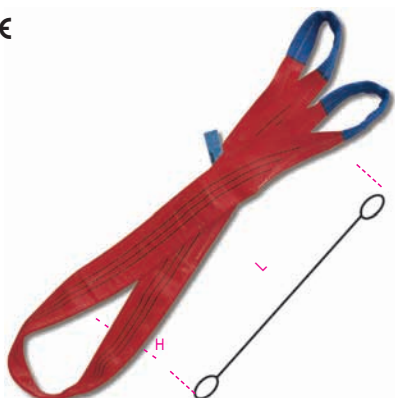

UNI EN 1492-1

L m	H mm	WLL ton		
2	150	5	1	081580020
3	150	5	1	081580030
4	150	5	1	081580040
5	150	5	1	081580050
6	150	5	1	081580060
8	150	5	1	081580080

8170

round slings

CE



UNI EN 1492-2

L m	WLL ton		
1	1	1	081700020
1,5	1	1	081700030
2	1	1	081700040

8173

round slings

CE



UNI EN 1492-2

L m	WLL ton		
1	2	1	081730020
1,5	2	1	081730030
2	2	1	081730040

8176

round slings

CE



UNI EN 1492-2

L m	WLL ton		
1	3	1	081760020
1,5	3	1	081760030
2	3	1	081760040
3	3	1	081760060

8177

round slings

CE



UNI EN 1492-2

L m	WLL ton		
1	4	1	081770020
1,5	4	1	081770030
2	4	1	081770040
3	4	1	081770060

8178

round slings

CE

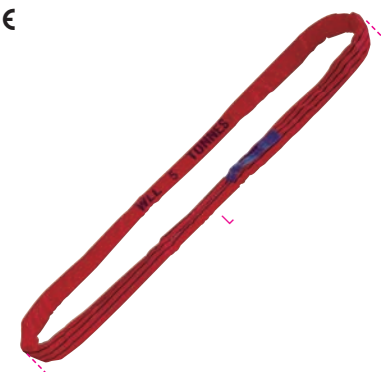

UNI EN 1492-2

L m	WLL ton		
1	5	1	081780020
1,5	5	1	081780030
2	5	1	081780040
3	5	1	081780060

H mm				$\beta = 0^\circ \div 45^\circ$	$\beta = 45^\circ \div 60^\circ$
30	1t	0,8t	2t	1,4t	1t
60	2t	1,6t	4t	2,8t	2t
90	3t	2,4t	6t	4,2t	3t
120	4t	3,2t	8t	5,6t	4t
150	5t	4,0t	10t	7,0t	5t



8180

ratchet tie down with single hook

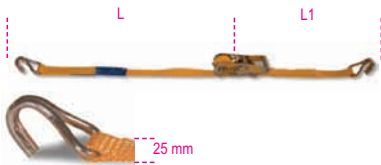

EN 12195-2

L mm	L1 mm		
3700	300	1	081800004
5700	300	1	081800006
7700	300	1	081800008

LC = 750 kg

8182S

ratchet tie down with double hook

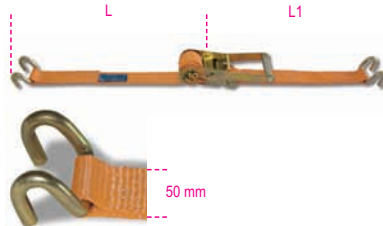

EN 12195-2

L mm	L1 mm		
8000	500	1	081820285
10000	500	1	081820305

LC = 2000 kg

8185

ring ratchet tie down

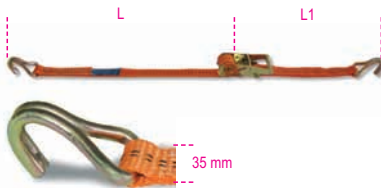

EN 12195-2

L mm	L1 mm		
3700	300	1	081810004
5700	300	1	081810006
7700	300	1	081810008

LC = 1000 kg

8182

ratchet tie down with single hook

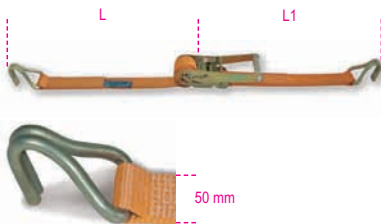

EN 12195-2

L mm	L1 mm		
8000	500	1	081820085
10000	500	1	081820105

LC = 2000 kg

8187

ring ratchet tie down



EN 12195-2

L mm			
5000		1	081870005
8000		1	081870008

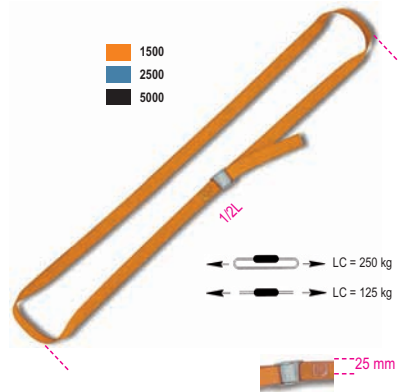
8188Fring cambuckles, LC 250 kg,
high-grade polypropylene (PP) strap

EN 12195-2

L mm			
1500		10	081880215
2500		10	081880225
5000		6	081880250

8188F/35ring cambuckles, LC 500 kg,
high-tenacity polyester (PES) strap

EN 12195-2

L mm			
4000		3	081880290

8188C

ring ratchet tie downs, LC 750 kg,
high-tenacity polypropylene (PP) strap



EN 12195-2

L mm	
5000	3 081880350



8205

eye and eye turnbuckles

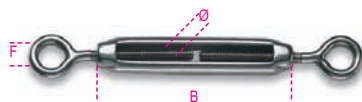

Ø mm	B mm	F mm		
M4	58	7	1	082050004
M5	70	9	1	082050005
M6	90	11	1	082050006
M8	120	13	1	082050008
M10	150	16	1	082050010
M12	200	20	1	082050012
M16	247	24	1	082050016
M20	305	28	1	082050020
M24	350	37	1	082050024

8206

hook and eye turnbuckles

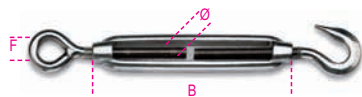

Ø mm	B mm	F mm		
M5	70	9	1	082060005
M6	90	11	1	082060006
M8	120	13	1	082060008
M10	150	16	1	082060010
M12	200	20	1	082060012
M16	247	24	1	082060016
M20	305	28	1	082060020

8207

hook and hook turnbuckles

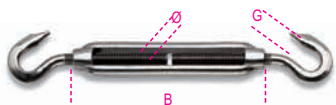

Ø mm	B mm	G mm		
M5	70	7	1	082070005
M6	90	9	1	082070006
M8	120	11	1	082070008
M10	150	12	1	082070010
M12	200	14	1	082070012
M16	247	18	1	082070016
M20	305	20	1	082070020

8209

jaw and jaw rigging turnbuckles

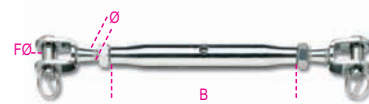

Ø mm	B mm	FØ mm		
M5	80	5	1	082090005
M6	90	5	1	082090006
M8	110	7	1	082090008
M10	121	9	1	082090010
M12	154	12	1	082090012

8216

wire rope clips



F mm	A mm	L mm		
2	M3	21	1	082160002
3	M3	21	1	082160003
4	M4	23	1	082160004
5	M5	25	1	082160005
6	M5	32	1	082160006
8	M6	35	1	082160008
10	M8	44	1	082160010
13	M10	55	1	082160013
16	M10	68	1	082160016

8220

thimbles

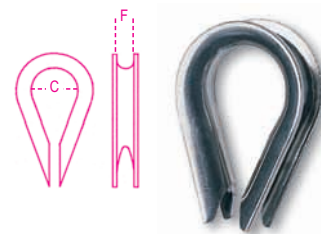

F mm	C mm		
2	7	1	082200020
3	10	1	082200030
4	11	1	082200040
5	13	1	082200050
6	14	1	082200060
8	18	1	082200080
10	23	1	082200100
12	27	1	082200120



8225

straight shackles



Ø mm	C mm	
4	8	1 082250004
5	10	1 082250005
6	12	1 082250006
8	16	1 082250008
10	20	1 082250010
12	24	1 082250012
16	32	1 082250016
19	37	1 082250019

8227

long, straight shackles



Ø mm	C mm	
4	9	1 082270004
5	11	1 082270005
6	13	1 082270006
8	17	1 082270008
10	19	1 082270010
12	26	1 082270012

8228

bow shackles



Ø mm	C mm	
4	8	1 082280004
5	10	1 082280005
6	12	1 082280006
8	16	1 082280008
10	20	1 082280010
12	26	1 082280013
16	32	1 082280016
19	38	1 082280019

8230

twisted shackles

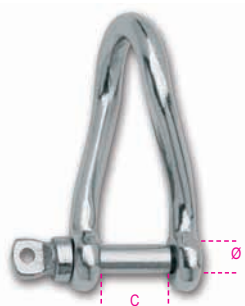

Ø mm	C mm	
4	9	1 082300004
5	11	1 082300005
6	12	1 082300006
8	16	1 082300008
10	21	1 082300010
12	24	1 082300012

8240

eyebolts

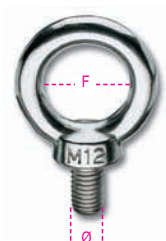

Ø mm	F mm	
M6	16	1 082400006
M8	20	1 082400008
M10	25	1 082400010
M12	30	1 082400012

8242

eye nuts

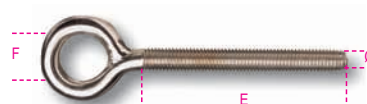

Ø mm	F mm	
M6	16	1 082420006
M8	19	1 082420008
M10	25	1 082420010
M12	30	1 082420012

8249fastening eyebolts
right thread

Ø mm	E mm	F mm	
M5	39	9	1 082490005
M6	51	11	1 082490006
M8	63	13	1 082490008
M10	74	16	1 082490010
M12	117	20	1 082490012

8250

spring eye hooks with latches



L mm	A mm	
50	6	1 082500050
70	10	1 082500070
100	13	1 082500100

8270

jaw and jaw swivels



Ø mm	C mm	L mm	
6	12	49	1 082700006
8	16	71	1 082700008
10	20	89	1 082700010
13	26	115	1 082700013
16	32	140	1 082700016
19	36	172	1 082700019

8272

eye and eye swivels

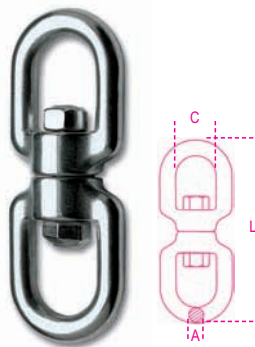

A mm	C mm	L mm		
5	13	59	1	082720005
6	15	65	1	082720006
8	20	90	1	082720008
10	24	115	1	082720010
13	32	152	1	082720013
16	39	188	1	082720016
19	41	230	1	082720019

8274

carabine hooks

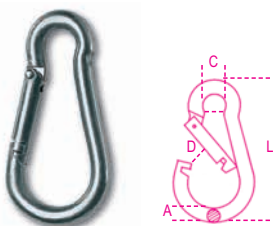

AxL mm	C mm	D mm		
5x50	8	8	1	082740005
6x60	9	9	1	082740006
7x70	11	9	1	082740007
8x80	12	10	1	082740008
10x100	15	12	1	082740010
11x120	18	16	1	082740011
12x140	23	25	1	082740012
13x160	23	30	1	082740013

8280

quick links

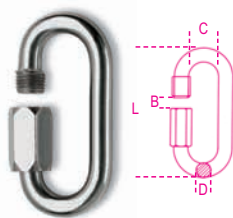

DxL mm	B mm	C mm		
3,5x36	4,0	8,5	1	082800003
4x40	5,5	11,5	1	082800004
5x49	6,5	13,0	1	082800005
6x57	7,5	14,5	1	082800006
7x66	8,5	16,0	1	082800007
8x74	10,0	17,5	1	082800008
10x89	12,0	20,5	1	082800010
12x105	15,0	23,5	1	082800012

8282

"S" hooks

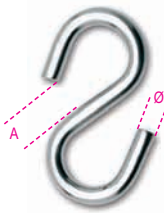

Ø mm	A mm		
3	5	1	082820103
4	6	1	082820104
5	7	1	082820105
6	9	1	082820106
8	10	1	082820108

8285

jaw terminals

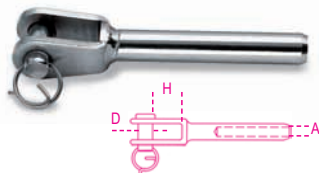

A mm	D mm	H mm		
3	5	9	1	082850003
4	6	9	1	082850004
5	8	11	1	082850005
6	9	13	1	082850006
8	12	22	1	082850008

Robur



8286

eye terminals



A mm	D mm		
3	6,5	1	082860003
4	8,5	1	082860004
5	10,0	1	082860005
6	12,5	1	082860006
8	14,5	1	082860008

8287

swage studs

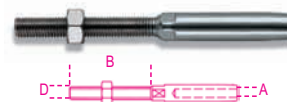

A mm	B mm	D mm		
3	50	M6	1	082870003
4	58	M8	1	082870004
5	66	M10	1	082870005
6	83	M12	1	082870006
8	100	M16	1	082870008

8290

pad eyes

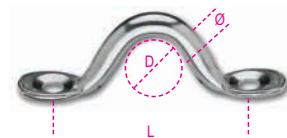

Ø mm	D mm	L mm		
5	12	40	1	082900005
6	16	45	1	082900006
8	13	47	1	082900008

8381SX

U bolts for pipes

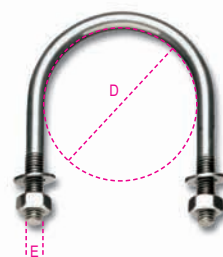

D mm	D gas	E mm		
11	1/8"	M6	200	083810401
14	1/4"	M6	200	083810402
18	3/8"	M6	200	083810403
22	1/2"	M6	200	083810404
27	3/4"	M6	200	083810405
34	1"	M6	200	083810406
43	1 1/4"	M6	200	083810407
49	1 1/2"	M8	100	083810408
61	2"	M8	100	083810409

Robur



Beta *Collection*

A range of exclusive products designed and developed to epitomize Beta's character, it comprises over 200 original, first-rate items: sports equipment, technical clothing and a variety of tailored objects.

An ideal medium for promotional actions, a must for recreational moments.

The right style with a view to really enjoying

Beta's
true spirit.

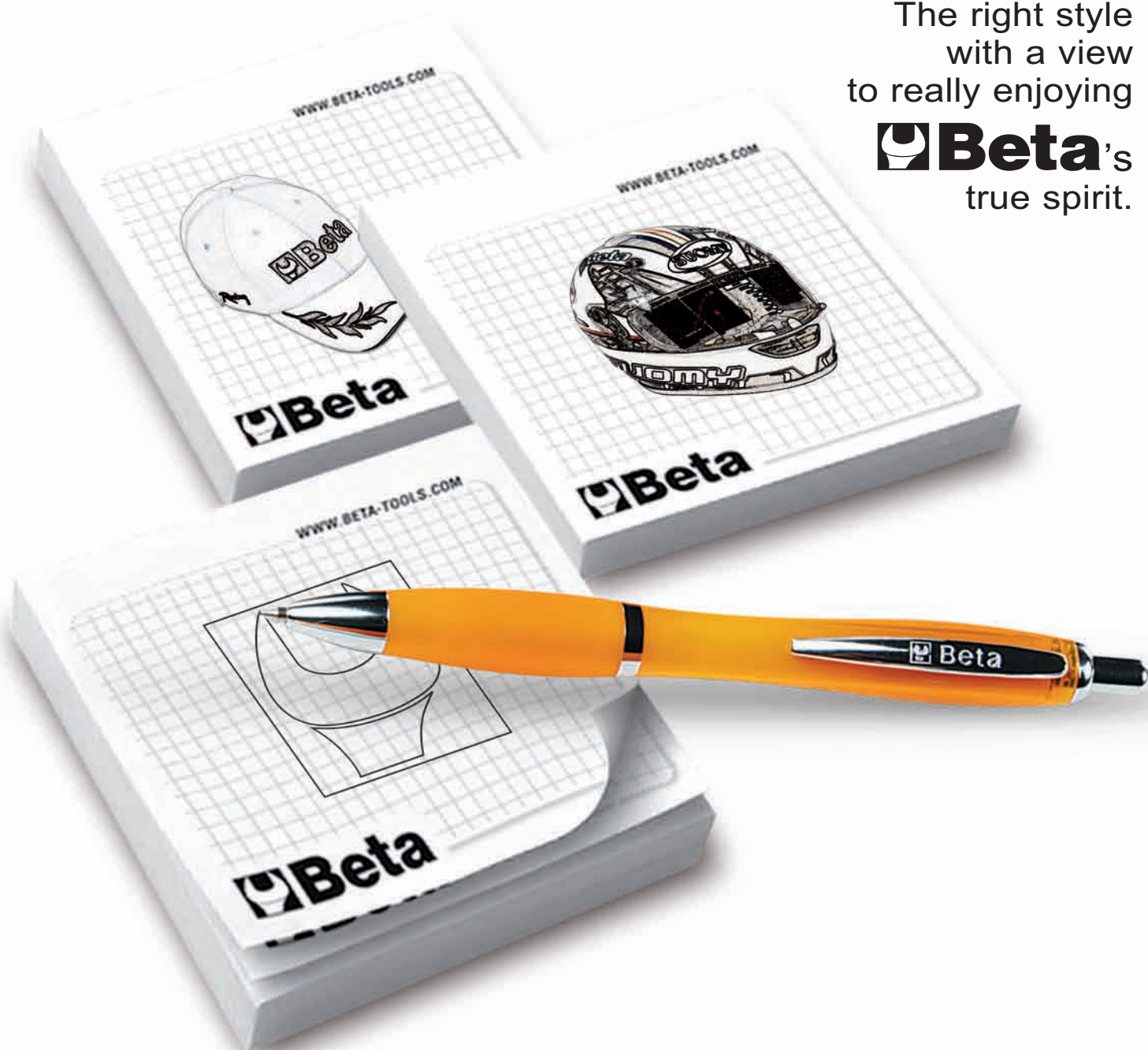

9593 SEIKO®

SEIKO® quartz analogue chronograph, steel case, 10 ATM water resistant, Japanese movement



9593 SEIKO®

1 095930010

9534W

three-button polo shirt, carded pique cotton 220 g/m², white



S	1	095340011
M	1	095340012
L	1	095340013
XL	1	095340014
XXL	1	095340015

9553Y

Yamaha® "racing" shirt, 100% cotton poplin, 125 g/m²



S	1	095530101
M	1	095530102
L	1	095530103
XL	1	095530104
XXL	1	095530105

9593 Breil®

Breil® multifunction quartz digital watch, 5 ATM water resistant, LCD dial, 12 digits



9593 Breil®

1 095930001

9534B

three-button polo shirt, carded pique cotton 200 g/m², blue



S	1	095340051
M	1	095340052
L	1	095340053
XL	1	095340054
XXL	1	095340055

9553K

Kawasaki® "racing shirt, 100% cotton poplin, 125 g/m²



S	1	095530201
M	1	095530202
L	1	095530203
XL	1	095530204
XXL	1	095530205

9593

analogue wristwatch, steel case and PVC strap, water resistant



9593

1 095930020



9554R

Retro style F1 shirt, pure cotton



XS	1	095542000
S	1	095542001
M	1	095542002
L	1	095542003
XL	1	095542004
XXL	1	095542005

9507

heavyweight sweater,
polyester/cotton 350 g/m²



SIZE	QTY	SKU
XS	1	095070000
S	1	095070001
M	1	095070002
L	1	095070003
XL	1	095070004
XXL	1	095070005

9503

"racing" jacket, nylon/PU



SIZE	QTY	SKU
S	1	095030001
M	1	095030002
L	1	095030003
XL	1	095030004
XXL	1	095030005

9552

full face helmet by SUOMY®



SIZE	QTY	SKU
S	1	095520101
M	1	095520102
L	1	095520103
XL	1	095520104
XXL	1	095520105

9537

fleece pullover, 100% polyester,
black antipilling finish



SIZE	QTY	SKU
M	1	095370002
L	1	095370003
XL	1	095370004
XXL	1	095370005

9500

original "Racing" jacket by Sparco, black,
exteriorly made from polyamide 100%;
removable sleeveless jacket, light grey



SIZE	QTY	SKU
M	1	095001002
L	1	095001003
XL	1	095001004

9552 JET

jet helmet by SUOMY®



SIZE	QTY	SKU
S	1	095520201
M	1	095520202
L	1	095520203
XL	1	095520204
XXL	1	095520205

9551G

sleeveless microfibre jacket, padded and lined,
blue



SIZE	QTY	SKU
XS	1	095510010
S	1	095510011
M	1	095510012
L	1	095510013
XL	1	095510014
XXL	1	095510015
XXXL	1	095510016

9508

pocket raincoat, polyester/PU



SIZE	QTY	SKU
M	1	095080002
L	1	095080003
XL	1	095080004

9525/ITA

cap with adjustable buckle strap, 100% cotton, 3D PVC transfer logo on front, directly embroidered. One size fits all.



9525/ITA 5 095250050

9525

cap, 100% cotton, one-size-fits-all adjustable buckle strap, directly embroidered visor and sides



9525 5 095251011

9525/N

cap, 100% cotton, one-size-fits-all adjustable buckle strap, directly embroidered front, sides and back, black



9525/N 5 095251021

9525/B

cap, 100% cotton, one size-fits-all adjustable buckle strap, directly embroidered front, sides and back, white



9525/B 5 095251031

9574B

work gloves



M	1	095740102
L	1	095740103
XL	1	095740104
XXL	1	095740105

95740

work gloves



M	1	095740202
L	1	095740203
XL	1	095740204
XXL	1	095740205

9518

"rope" belt, 100% polyester



cm		
90	1	095180090
100	1	095180100
110	1	095180110
120	1	095180120
130	1	095180130

9544T

multifunction trolley with padded computer compartment and separate document compartment. Dimensions: 55x22x44 cm



cm 55x22x44 1 095440000



9557J

sports bag, 600 D polyester / PVC



cm
58x27x30 1 095570011

9557N

"Racing" bag, made from waterproof PVC coated fabric



cm
80x35x35 1 095570001

9541

sports computer rucksack, 600D polyester / PVC. 1680D and 420D/PU insets



cm
43x39x16 1 095410000

9543

business computer bag 1680D polyester



cm
40x28x10 1 095430000

9542

shoulder bag, 420D nylon



cm
35x27x10 1 095420000

9540M

multi-pocket pouch, 420D nylon / PVC



9540M 1 095400011

9524PD

travelling briefcase, leather



9524PD 1 095240010

95210/OB

"racing" umbrella, 190T nylon, 150 cm in diameter



95210/OB 1 095210011

**9599CB**

Atala® city bike, 49 cm aluminium frame, Shimano® 6 speed gear, V-brake®, 28" aluminium rims



9599CB 1 095990011

9598MB

Atala® mountain bike, 48 cm aluminium frame, front shock absorber, Shimano® 21 speed gear, aluminium V-brake®, 28" aluminium rims



9598MB 1 095980011

9539C

protective cycling helmet, outer cap made from polycarbonate, inner cap made from black, high-density EPS; adjustable size 59-62



CE EN 1078

9539C 1 095391000

9539

biking jersey & bib shorts, honeycomb polyester jersey, three rear pockets, stretch bib shorts, antibacterial, antishock seat padding



M	1	095390013
L	1	095390014
XL	1	095390015

9539P

overalls with front mini-zip, made of super Roubaix fabric, Coolmax® bottom



M	1	095390033
L	1	095390034
XL	1	095390035

9520M

t-shirt made of 3D dry effect fabric, antiallergenic and antibacterial



S	1	095200001
M	1	095200002
L	1	095200003
XL	1	095200004
XXL	1	095200005

9520C

sports singlet made of 3D dry effect fabric, antiallergenic and antibacterial



S	1	095200011
M	1	095200012
L	1	095200013
XL	1	095200014
XXL	1	095200015

9539G

plush jacket, with long zip, 100% made of polyester, 3 rear pockets, 1 document pocket



M	1	095390023
L	1	095390024
XL	1	095390025

**9539R**

sleeveless windstopper with long zip, 100% made of polyester



M	1	095390043
L	1	095390044
XL	1	095390045

9520P

shorts made of technical microfibres, with reflecting insert and rear document pocket



S	1	095200021
M	1	095200022
L	1	095200023
XL	1	095200024
XXL	1	095200025





9594

clock complete with thermometer and hygrometer, 26 cm in diameter



Ø
cm
26

1 095940051

9528/P

5" football, PVC



9528/P

1 095280001

9547C

table calculator, 10 digits, dimensions 21x29.5x1 cm



cm
21x29,5x1

1 095470101

9523MB

snorkelling set, mask and snorkel



9523MB

1 095231000

9586

multipurpose knife, stainless steel, 10 functions



9586

1 095861001

9547WSK

"Kinder Work Station", workbench with tools, for children from 3 years of age



87
cm

9547WSK

1 095473801

9581

petrol lighter



9581

1 095811001

9577F1

overalls, 65/35 polyester/cotton



S	1 095771001
M	1 095771002
L	1 095771003
XL	1 095771004
XXL	1 095771005
XXXL	1 095771006

9577F1/P

overalls, customised back



S	1 095771100
M	1 095771102
L	1 095771103
XL	1 095771104
XXL	1 095771105
XXXL	1 095771106

9579C

work jacket, polyester/cotton



Size	Quantity	Code
M	1	095791002
L	1	095791003
XL	1	095791004

9579C/P

work jacket, customised back



Size	Quantity	Code
M	1	095791102
L	1	095791103
XL	1	095791104

9575

suction cup folder, made from plasticized fabric, with four suction cups on upper side



9575	1	095750001
------	---	-----------

9575P

suction cup folder, customised



9575P	50	095750101
-------	----	-----------

9559

one-sided banner, TNT; modules: 3x0.8 m



9559	1	095591001
------	---	-----------

9590

flag, silk screen printed nylon



cm	Quantity	Code
140x215	1	095900001

9582E

luminous sign, one-sided, for outdoor use, 30W - 220V



30x105	1	095821001
--------	---	-----------

9582I/L

luminous sign, two-sided, for indoor use, 30W - 220V



30x64	1	095821051
-------	---	-----------

9592S/50P

50 ballpoint pens, plastic



9592S/50P	1	095921001
-----------	---	-----------

9592P/P

ballpoint pens, customised



9592P/P	500	095921501
---------	-----	-----------

9596

badge holder, polyester, with metal clip and mobile phone string



9596	10	095961001
------	----	-----------

9595S/10P

10 key rings, EVA-type plastics



1 095951001

9569

shopper, made from sturdy polyethylene, folded sides



cm 44x34 50 095691001

9588S/10...

set of 10 notepads



9588S/10A	21x29 cm	1 095881001
9588S/10B	15x21 cm	1 095881002
9588S/10C	10x15 cm	1 095881003
9588S/10D	7,5x10,5 cm	1 095880054

9588/10PI

set of 10 notepads with adhesive sheets



9588/10PI 7,5x7,5 cm 1 095880055

9591S/...

clear stickers



* 9591 S/10A	60x14,6 cm	1 095911001
* 9591 S/10B	38x10,7 cm	1 095911002
° 9591 S/50C	26x7,8 cm	1 095911003
° 9591 S/50D	13x3,9 cm	1 095911004

9589A/36

pack of 36 rolls of packaging adhesive tape, with Beta logo, tawny



9589A/36 1 095890035

9589B/36

pack of 36 rolls of packaging adhesive tape, with Beta logo, white



9589B/36 1 095890036

Beta

Beta

Items subject to availability

1376A	
 g	
300	013760203
400	013760204
500	013760205

1376B	
 g	
300	013760303

1410/1 - 1410/2	
L	
mm	
205	014100001
200	014100002

1479V/13	
1479V/13	014790020

1479V/32	
1479V/32	014790025

1479U/DP	
1479U/DP	014790030

1479/S3	
1479/S3	014790300
1479RB/1-1479RB/2	
1479RB/3	

1481/...	
Ø max	
mm	
10	014810001
15	014810002
25	014810003
45	014810004

1481/S4	
1481/S4	014810020
1481/10-1481/15	
1481/25-1481/45	

1494	
 mm	
8x10	014940001
8x3/8	014940002
10x11	014940003
12x13	014940004
14x17	014940005
19	014940006

1494PB	
 mm	
17	014940010

1494/C6	
1494/C6	014940020

1494XZN	
M	014940040

1494/C14	
1494/C14	014940100

1500GL/...	
L	
mm	
300	015000215
400	015000216
500	015000217

1548/...	
L	
mm	
130	015480001
170	015480002
185	015480003
220	015480004
220	015480005

1548G4/...	
L	
mm	
140	015480011
140	015480012
170	015480013
170	015480014
175	015480015
175	015480016
225	015480017
225	015480018

1548/C5	
1548/C5	015480019

1555B	
A	
min+Max	
mm	
110÷317	015550200

1570/1 - 1570/2	
L	
mm	
52÷58	015700001
75÷87	015700002

1691/...	
L	
m	
3	016910003
5	016910005
8	016910008
10	016910010

1692B/...	
L	
m	
2	016920022
3	016920023
5	016920025

1696C	
L	
mm	
300	016960303
400	016960304
500	016960305
600	016960306

1760A	
1760A	017600010

1771F	
1771F	017710030

1772J	
1772J	017720021

1773	
1773	017730001

1777MQ	
1777MQ	017770010

1830	
1830	018300001

1840	
1840	018400001

1840B	
1840B	018400020

1841	
1841	018410001

1841A	
1841A	018410010

1920C	
1920C	019200002

1920L	
1920L	019200005

1922	
1922	019220001

1922I	
1922I	019220005

1923C	
1923C	019230002

1923SA	
1923SA	019230030

1923SB	
1923SB	019230040

1924	
1924	019240001

1924S	
1924S	019240005

1926S	
1926S	019260008

1927D	
1927D	019270003

1927KP	
1927KP	019270100

1928ND	
1928ND	019280002

1928S	
1928S	019280008

1928KP	
1928KP	019280100

1932A	
1932A	019320001

1932S	
1932S	019320002

1932B	
1932B	019320005

1932AN	
1932AN	019320007











1932I	
1932I	019320010

1932RS	
1932RS	019320013

1934	
1934	019340001

1934S	
1934S	019340002

Items subject to availability

1934I		C22 - 2200		3020AL/1		7223NK	
1934I	019340005	C22 O	022000300	3020AL/1	030200001		
		C22 G	022000301			EU UK	
1934L		C22 R	022000302	T...		35	2,5 072230035
1934L	019340015					▼	▼
		CD23N O		T21	024240021	47	12 072230047
1934AN		CD23N O	023000210	T62	024240062		
1934AN	019340020			T115	024240115		
1934AV		C23 - 2300		T116	024240116		
1934AV	019340025	C23 O	023000300	T165	024240165		
		C23 G	023000301	T166	024240166		
1935A		C23 R	023000911	T190	024240190		
1935A	019350010			T191	024240191		
		C23C - 2300C		T192	024240192		
1935B		C23C O	023000302	T193	024240193		
1935B	019350015	C23C G	023000303	T195	024240195		
		C23C R	023000913	T196	024240196		
1935C		C24XL - 2400XL		T197	024240197		
1935C	019350020	C24XL	024000005	T200	024240200		
				T203	024240203		
1935D		CX24 - 2400CX		T261	024240261		
1935D	019350025	CX24 O	024000201				
		CX24 G	024000202	7201N			
1938/7		CX24 R	024000082				
1938/7	019380007			EU UK			
		CX24/W - 2400W		38	5 072010238		
1938RP		CX24 O/W	024000085	▼	▼		
1938RP	019380010	CX24 G/W	024000087	48	13 072010248		
		CX24 R/W	024000086				
2007PM		C24/PM		7202N			
2007PM	020070000	C24/PM	024000116				
		C24/PU		EU UK			
2008CR		C24/PU	024000119	38	5 072020138		
2008CR	020080000			▼	▼		
2031/VV		C24 - 2400		48	13 072020148		
2031/VV	020310010	C24 O	024000203	7203N			
		C24 G	024000204				
2040UC		C24 R	024000209	EU UK			
2040UC	020400020			38	5 072030138		
		C24H - 2400H		▼	▼		
2050M		C24H O	024000205	48	13 072030148		
2050M	020500011	C24H G	024000206	7204N			
		C24H R	024000208				
2055L		C24H6 - 2400H6		EU UK			
2055L	020550012	C24H6 O	024000235	38	5 072040138		
		C24H6 G	024000236	▼	▼		
		C24H6 R	024000238	48	13 072040148		
		C28T - 2800T		7210N			
		C28T O	028000013				
		C28T G	028000016	EU UK			
		C28T R	028000014	35	2,5 072100135		
				▼	▼		
				48	13 072100148		
				7211N			
							
				EU UK			
				35	2,5 072110135		
				▼	▼		
				48	13 072110148		
				7216N			
							
				EU UK			
				35	2,5 072160135		
				▼	▼		
				47	12 072160147		
				7285NK			
							
				EU UK			
				35	2,5 072850135		
				▼	▼		
				47	12 072850147		
				7303NKK			
							
				EU UK			
				36	3,5 073030236		
				▼	▼		
				48	13 073030248		

Items subject to availability

7304NKK

EU	UK		
36	3,5		073040236
▼			▼
48	13		073040248

7305

EU	UK		
36	3,5		073050036
▼			▼
48	13		073050048

7307NKK

EU	UK		
36	3,5		073070036
▼			▼
48	13		073070048

7308NKK

EU	UK		
36	3,5		073080036
▼			▼
48	13		073080048

7317AK

EU	UK		
36	3,5		073170036
▼			▼
47	12		073170047

7319AK

EU	UK		
36	3,5		073190036
▼			▼
47	12		073190047

7328B

EU	UK		
38	5		073280138
▼			▼
47	12		073280147

7333NKK

EU	UK		
35	2,5		073330035
▼			▼
47	12		073330047

7334NKK

EU	UK		
35	2,5		073340035
▼			▼
47	12		073340047

7335NKK

EU	UK		
38	5		073350038
▼			▼
47	12		073350047

7380

EU	UK		
42	8		073800042
▼			▼
46	11		073800046

7380B

EU	UK		
39	6		073800239
▼			▼
46	11		073800246

7383B

EU	UK		
36	3,5		073830236
▼			▼
45	10,5		073830245

7385A

EU	UK		
36	3,5		073850136
▼			▼
44	10		073850144

7385B

EU	UK		
46	11		073850246

7388B

EU	UK		
36	3,5		073880236
▼			▼
46	11		073880246

7390

EU	UK		
39	6		073900039
▼			▼
46	11		073900046

7390A

EU	UK		
36	3,5		073900136
▼			▼
46	11		073900146

7391

EU	UK		
39	6		073910039
▼			▼
45	10,5		073910045

7392A

EU	UK		
36	3,5		073920136
▼			▼
46	11		073920146

7393

EU	UK		
38	5		073930038
▼			▼
47	12		073930047

7395

EU	UK		
40	6,5		073950040
▼			▼
46	11		073950046

7396

EU	UK		
39	6		073960039
▼			▼
47	12		073960047

7500

XS			075000146
▼			▼
XXL			075000156

7510

M			075100250
L			075100252
XL			075100254

7510

XS			075100046

7511

XS			075110046
S			075110048

7511

M			075110150
L			075110152
XL			075110154

7511

XS			075110246
▼			▼
XXL			075110256

7512

XXXL			075120058

7513

XS			075130046
XXXL			075130058

7521

XS			075210046
▼			▼
XXL			075210056

7530

S			075300001
▼			▼
XXL			075300005

7531

S			075310001
▼			▼
XXL			075310005

7541

S			075410001
▼			▼
XXL			075410005

7541

S			075410101
▼			▼
XXL			075410105

7545

S			075450001
▼			▼
XXL			075450005

7550

S			075500001
▼			▼
XXL			075500005

7554

S			075540001
▼			▼
XXL			075540005

7554

S			075540101
▼			▼
XXL			075540105

7554

S			075540301
▼			▼
XXL			075540305

7555

S			075550001

7565

S			075650001
▼			▼
XXL			075650005

Items subject to availability

7566

S	075660001
▼	▼
XXXL	075660006

7575

S	075750001
▼	▼
XXL	075750005

7576

XS	075760000
▼	▼
XXXL	075760006

7585

S	075850001
▼	▼
XXL	075850005

7595

S	075950101
▼	▼
XXL	075950105

7615

S	076150001
▼	▼
XXL	076150005

7620

XL	076200004
XXL	076200005

7691

S	076910001
▼	▼
XXL	076910005

7693

S	076930001
▼	▼
XXL	076930005

7700

S	077000101
▼	▼
XXL	077000105

7720

S	077200001
▼	▼
XXL	077200005

7720

S	077200101
▼	▼
XXL	077200105

7731

XXL	077310005

7740

S	077400101
▼	▼
XXL	077400105

7740

XXL	077400205

7760

S	077600001
▼	▼
XXL	077600005

7760

L	077600103
XL	077600104
XXL	077600105

7770

S	077700001
▼	▼
XXL	077700005

7805

XXXL	078050006

7807

XXXL	078070006

7970

XS	079700100
▼	▼
XXL	079700105

7970

XS	079700200
▼	▼
XXL	079700205

7973

XS	079730100
▼	▼
XXL	079730105

7973

XS	079730200
▼	▼
XXL	079730205

7979

S	079790101
▼	▼
XXL	079790105

7979

S	079790201
▼	▼
XXL	079790205



8041EALN

∅	
mm	
M8	080410008
M10	080410010
M12	080410012
M14	080410014
M16	080410016
M18	080410018
M20	080410020
M22	080410022
M24	080410024

8043EALN

∅	
mm	
M8	080430008
M10	080430010
M12	080430012
M14	080430014
M16	080430016
M18	080430018
M20	080430020
M22	080430022
M24	080430024

8061

WLL	
kg	
2000	080610020
3150	080610032
5300	080610053

8068

WLL	
kg	
500	080680005
1000	080680010
2000	080680020
3000	080680030
4000	080680040
6000	080680060
8000	080680080

8188MC

L	
mm	
* 1500	081880015
* 2500	081880025
5000	081880050

8188MN

L	
mm	
5000	081880125

2010		→	2011	
012600001	1260		012530001	1253
012600010	1260A		012530010	1253A
012600001	1262		012540001	1254
019950301	1995NS-N		016390025	1639
015000227	1500GL8A		015800227	1580GL8A
015000228	1500GL8B		015800228	1580GL8B
015000229	1500GL8C		015800229	1580GL8C



A large, empty grid of 20 columns and 40 rows, occupying most of the page, intended for taking notes or working on problems.

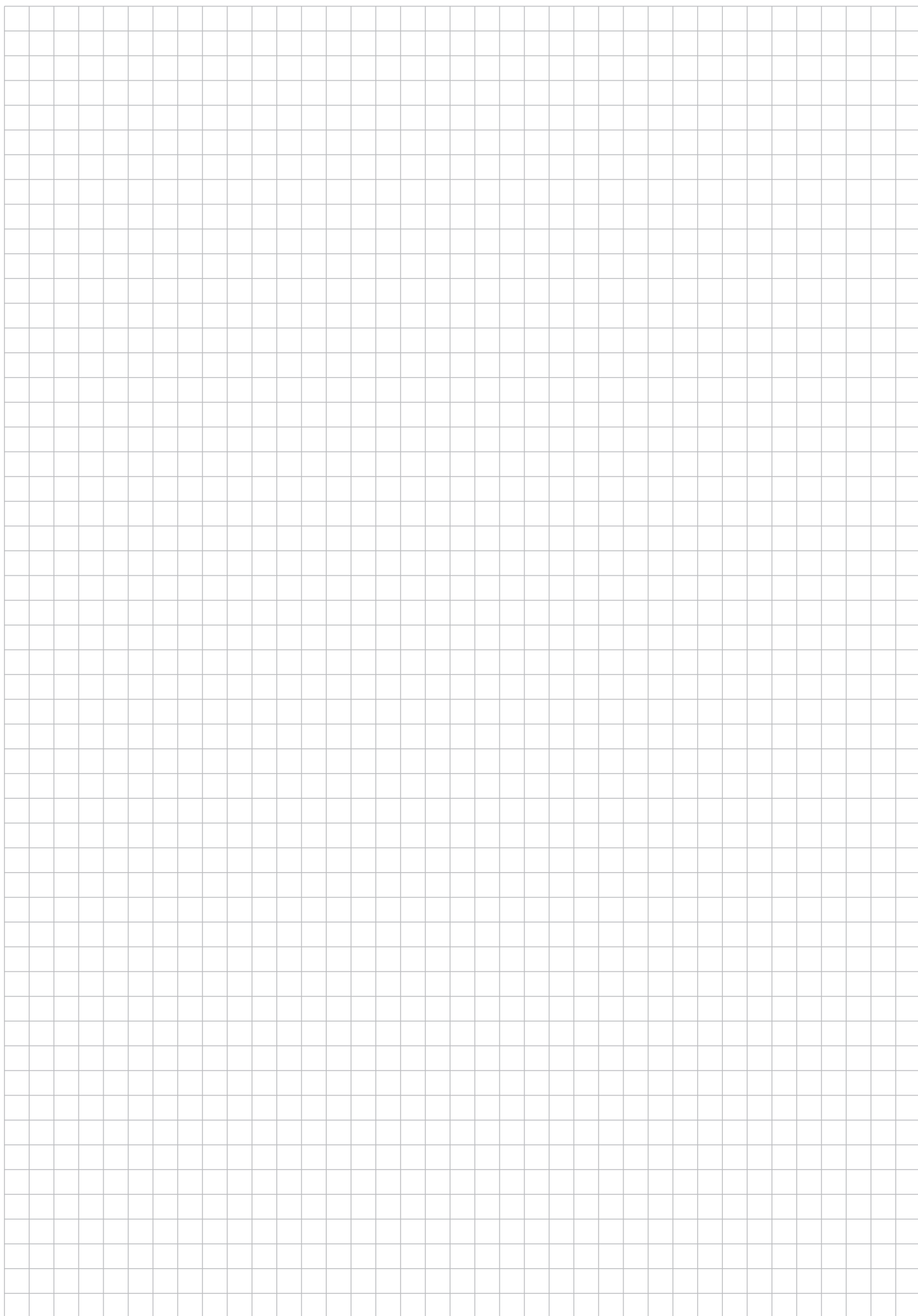





Adjustable wrenches	19, 170, 175
Amperometric clamps	159-160
Assortments of tools in thermoformed trays	259÷269
Automatic cable reels with inspection lamps	165-166
Automatic hose reel for compressed air or cold water	187
Barrel pumps	167
Beta Collection	358÷366
BetaEasy screwdrivers	101-102
BetaGrip screwdrivers	105÷107
BetaMax screwdrivers	108÷111, 176
Bevel protractor	146
Bit reamers	151
Bits and bit holders	19÷21, 53÷58, 107, 111
Blister pack range	273÷277
Bolt cutters	94
Bonding guns	156-157
Bottle holders	202
Bristle brush	154
Brushes	154
Cable cutters	96
Cable cutters for steel cables	96
Cable stripping tools and wire stripping pliers	97
Callipers	146-147
Cape chisels	8
Carpenter's pencil	148
Centre punches	7
Chalk line reels and powder	150
Circlip pliers	89
Clamps	139-140
Clamps	139-140
Combination pliers	97-98, 171, 176
Combination wrenches	8÷10, 20, 174
Crimping pliers for terminals and terminals	140÷143
Crowfoot wrenches	65
Cutting nippers for electronic purposes	100
Desoldering pumps	164
Diagonal and end cutting nippers	92-94, 100, 171, 175
Dial indicators	145
Dies and assortments	36÷39
Digital tachometer	160
Display units for sales points	278÷293
Double ended hexagon / bi-hex offset socket wrenches	79-80
Double swivel end socket wrenches	12
Double-ended offset ring wrench for scaffolding bolts	13
Drift punches	7, 174
Ear protectors	188
Electrician's scissors	95-96
Electronic torque meter with Dynatester transducer	43, 47
Engineer's scribes	147
Extractors for damaged screws and studs	117-118
Extra-flat chisels with straight cutters	113
Files	32, 151÷153

Index



Filtering mask	188
Fitting tool for ties and ties	156
Fixed frame hacksaw	154
Flare nut open ring wrenches	14
Flat chisels	7-8, 174
Flexible magnetic pickup tools	150
Flexible pickup tools	151
Foldaway knives	162-163
Friction tape	143
Gas welding handles	21-22
Graduated rules	147
Hacksaw frames and blades	153-154, 176
Hammers	113÷117, 176
Hand crimper steel matrix	92
Hand punch steel punch and matrix	92
Hand sockets, accessories and assortments, 1/4"	58÷62
Hand sockets, accessories and assortments, 3/8"	62÷67
Hand sockets, accessories and assortments, 1/2"	68÷76, 170, 175
Hand sockets, accessories and assortments, 3/4"	76-77
Hand sockets, accessories and assortments, 1"	78
Hand taps and assortments	33÷35, 39-39
Heat guns	166-167
Heating plates for manual straight and slanted welding of plastic pipes	21
Heavy-duty cable cutters	94
Hi-torque hexagon nut spinners with handles	80-81
Holesaws and hole cutters and accessories	39÷41
Hook wrenches	18-19
Hot glue guns	167
Hub and wheel drum pullers	134
Hydraulic presses	138
Hydraulic pullers	139
Impact screwdrivers	110
Impact sockets, accessories and assortments	47÷53, 179-180
Inspection mirrors	151
Insulated tools, 1000 V	169÷172
Insulating gloves	172
Insulating mat	172
Lamps	164÷166, 222
Laser distance gauge	148
Lever operated grease guns	157
Locking wire pliers	161
Long and extra-long nose pliers	88-89, 98-99, 171-172
Lump hammers	116, 176
Magnetic tool holders	161
Magnetizer/demagnetizer	101
Mains testing screwdrivers	103-104
Masonry chisels	149-150
Measuring tapes	148
Metric feeler gauges	150
Micrometers	144-145
Microscrewdrivers	102÷104
Mobile roller cabs	198÷203, 206÷214
Morse taper extractors	33

Index

	☐
Multimeters	159-160
Nut splitters	150
Offset hexagon key wrenches for Torx® head screws	14÷18, 175
Offset hexagon key wrenches for Torx® head screws, with high torque handles	17-18, 104, 106, 110
Offset key wrenches with XZN® profile	18
Offset screwdrivers	103
Oil cans	157-158
Panel toolholders	222, 224
Paper roll holder	201-202
Parallel bench vices	140
Pen oiler	158
Pin punches	7
Pincers	93-94
Pipe benders	27
Pipe cutters	22÷24
Pipe reamers	24
Pipe wrenches	26-27
Pivoting clamp vices, for plumbing purposes	28
Pliers for electronic purposes	99
Plumbing tools	21÷28
Pneumatic tools and accessories	177÷188
Polywelders and forms	21
Portable tool chests	195-196, 210, 215
Protractors	146
Pry bars	86, 150
Pullers	131÷136, 138-139
Punch press	143-144
Punches	94-95
Radius gauges	150
Ratcheting wrenches	19÷21, 126
Ratchet-type shears for PVC pipes	23
Reversible screwdrivers	107-108
Revolving punch pliers	161
Ring wrenches	12÷14, 19÷21, 171, 175-176
Riveting pliers and rivets	154-155
Robur wire rope accessories	341÷357
Safety footwear	294÷321
Safety goggles	188
Scissors	95-96, 163
Scrapers	126, 151, 162
Screw pitch gauge	150
Screwdrivers with steel heads	103
Screwholding screwdrivers	103
Self-locking pliers	90÷92, 127
Shears	95
Single and double open end wrenches	10÷12, 170, 174
Sledge hammers	116, 176
Slip joint pliers, boxed joints	90, 175
Slogging wrenches	11-12, 175
Soft face hammers	117, 176
Soldering irons	163-164
Sparkproof tools	173÷176
Special end mills for welding	31

Index



Spirit levels and levelling staffs	148-149
Spring tweezers	87-88, 163
Squares	145-146
Stainless steel helicoids	35-36
Stepped drills	32
Suction lifters	161
Support for impact wrenches	202
Tap wrenches and die stocks	35, 37
T-handle hexagon socket wrenches for Torx® head screws	81÷83
T-handle wrenches with three hexagon male ends for Torx® head screws	81÷83
Thermoformed tool trays	259÷270
Thermometers	160
Three-leg pullers	133-134
Tool accessories for cabinets, drawers and panels	270÷272
Tool assortments	226÷258
Tool bags	190, 193
Tool boxes	193-194, 217
Tool cabinets	218-219
Tool cases	190÷192
Tool chest trolleys	197
Tool pouches with belts	190
Tool trolleys	203÷205, 217-218
Tool trolleys	191-192, 216
Tool trunks	193-194
Torches	164
Torque angle indicators	44
Torque bars	45, 46
Torque multipliers	41÷43
Torque screwdrivers	43
Torque wrenches and bars	43÷47, 170
Tube flaring pliers	24-25
Tube flaring tools	24-25
Tubular socket wrenches	79-80
Twist drills with cylindrical shanks	28÷31
Two-leg pullers	131÷134
Utility knives	161-162
Voltage tester	130, 166
Welding machines	167
Workbenches	220÷225
Workshop verniers	144, 146
Workwear	322÷340

Automotive

Index of car vehicle tools

	☐
Acid densimeter, glass body	158
Adjustable body blade holders with flexible flat blades	113
Adjustable self-locking pliers for brake hoses	123
Adjustable self-locking pliers for exhaust pipe cutting	125-126
Antifreeze densimeter, glass body	158
Ball joint pullers	138
Battery chargers	130-131
Battery fillers	158
Battery lug and post cleaner steel brush	154
Brake fluid extractors	122
Brake fluid tester	123
Brake spring pliers	123
Bushing drivers	138
Chain opening tool	138
Claw hammers	113-114
Compressors for shock absorber springs	136-137
Cooling system seal testers	158
Creeper	168
Curved angled spoons	112-113
Diesel injector test and calibrating hand pump	84
Digital common rail high pressure tester	86
Dollies	111-112
Engine brackets	168
Engine head support	119
Engine oil-filter wrenches	127÷129
External butt-ended circlip pliers	119
Four-way hexagon wheel nut wrenches	87
Gas oil filter wrenches	128-129
Gauge for tyre threads	150
Heavy vehicle tools	87, 137-138
Heavy vehicle wheel hub nut locking sockets	87
Homokinetic joint pullers	138
Hose clamp pliers	124-125
Hose pliers	126-127
Hydraulic bottle jacks	168
Impact sockets for wheel nuts	48-49
Instrument for controlling compression on petrol and Diesel engines	85-86
Jack stands	168
Leaf spring pin sockets	137
Oil seal wrenches	129-130
Packing removal tool	134
Piston ring compressors	119
Plastic funnel	158
Pneumatic valve grinder	119
Quick coupler pliers for fuel pipes	127
Rotary brushes for cleaning wheel hubs	122
Seat with castors	168
Sliding gauges for brake discs and drums	144

Automotive

Index of car vehicle tools



Sockets for Diesel engine injectors	84
Sockets for Lambda probes	84
Sonoscope probe	131
Spark plug pliers	125
Spark plug wrenches and sockets	83-84
Spring pulling hook wrenches	117, 125, 153
Starters	130
Tester for batteries and recharging systems	131
Timing devices	120÷122
Tool for disc brake pistons	123-124
Tools for pulling out car radios	161
Tools for removing glass windows	114, 161
Trim pin removers	126
Tyre inflator	185
Tyre levers	86
Universal clutch aligner	119
Valve depressors for disc removal	123
Valve seat removing tool	120
Valve spring compressors	119
Valve timing system pulley locking tools	122, 126-127, 134
Vapour extractor	84
Voltage tester	130, 166
Wheel balancing weight tool	87
Wheel hub nut locking sockets	86-87
Wrench for removing steering arms	138
Wrenches for fuel tank floating ring nuts	127



Beta





Beta



Beta

2010 Partnership

